

Price list

DKK – Valid from 01.04.2024

HÅG

Celebrating movement



Table of contents

General sales and delivery terms	3
HÅG SoFi® - task chairs	6
HÅG SoFi® - communication chair	8
HÅG Capisco® - task chair	10
HÅG Capisco Puls® - task chair	12
HÅG® Tion - task chair	14
HÅG Futu® - task chair	16
HÅG Futu® - communication chair	18
HÅG executive collection - Fabrics and Colours	20
HÅG® Tribute - task chair	22
HÅG® Tribute - meeting chair	23
HÅG® Excellence - task chair	24
HÅG® Excellence - meeting chair	25
HÅG® Inspiration - task chair	26
HÅG® Inspiration - meeting chair	27
HÅG Creed® - task chair	28
HÅG Creed® - communication chair	30
HÅG H03® - task chair	31
HÅG® Celi - conference chair	32
HÅG Conventio® - conference chair	34
HÅG Conventio Wing® - conference chair	36
HÅG Accessories	38
Main Spare Parts	39
Physical Measurements - HÅG task and meeting chairs	46
Physical Measurements - HÅG conference chairs	51
Product Tests	52
Environmental Certificates	53
HÅG Quick-ship	54
HÅG Fabrics and Colours (FutuKnit)	55
HÅG Fabrics and Colours PLASTIC & METAL	56
HÅG Standard fabrics & colour collection 2024	60
Curated Fabric & Colour Collection	69
Extended Fabric & Colour Collection	70
Colour Matrix	72

General sales and delivery terms

This document applies for contracted distributors of HÅG in Denmark (including Faroe Islands and Greenland).

CUSTOMER SERVICE

Flokk A/S
Phone: +45 99 50 55 00
E-mail: info-dk@flokk.com
flokk.com

Flokk reserves the right to make small construction alterations without notice.

STANDARD DELIVERY TIMES

Standard dispatch times from factory	Working days
Quick-ship (after the order has been registered)	5-10
Standard Fabric & Colour Collection	10-15
Curated Fabric & Colour Collection	15-20
Extended Fabric & Colour Collection	25-30*
On request	on request

2-3 transport days to be added on top of production lead time.

* Provided that the supplier has the fabric in stock.

Longer delivery times may occur periodically, during holidays and for large orders.

Larger orders with polished and tumbled (HÅG Tion only) aluminium, wood back/seat or 3D armrests specified may cause longer lead times.

ORDER ENTRY SPECIFICATIONS

When placing your order please remember to specify the following information:

- Chair model
- Number of chairs
- Fabric/Leather and Colour Code
- Plastic colour on HÅG Capisco Puls, HÅG Conventio Wing and HÅG Celi
- Colour on seat&back, back stem, lift, five star base, (armrests optional) on HÅG Tion
- Colour of base
- Type of castors or glides
- Delivery date
- Delivery address
- Project no. (if any)

Colour on base

Where a base is specified in black, other metal components will also be in black, if not specified in other colours. Similarly, chairs on silver bases have metal components in silver. Other metal colours need to be specified for chairs with polished aluminium bases (extra cost option). Specified combinations are defined for:

- HÅG SoFi
- HÅG executive

Castors

Both hard and soft castors and glides are supplied according to EN 1335 Class A standard, and must be specified at time of order (soft for hard flooring, hard for soft flooring). Additional castor options are available on request, but must be specified at time of order and the delivery lead time may be increased. Price on application.

PRICES

All prices in DKK exclusive of VAT. Valid from 01.04.2024. Quotations are valid for 30 days unless otherwise agreed.

Any typographical errors shall not be binding for Flokk and will be subject to correction without liability to the vendor.

CONDITIONS OF DELIVERY

Ex Works (Incoterms 2020), including packaging. A 3% transportation & energy cost surcharge on the net order value will be applied to all orders with delivery terms agreed different from Ex Works.

Shipping fee of 5% of the net order value (min. DKK 250) is added on all orders, which is not delivered to addresses used or owned by the distributor.

Time specific delivery on a specific date and time indication costs DKK 5.000 per. order and must be ordered no later than five days before the sending date via Customer Service, Flokk A/S.

Visible transport damage and discrepancies in the number of items received must always be noted on the bill of carriage at the time of receipt and reported to the carrier and Customer Service, Flokk within 7 days after receipt.

Invisible damage (means no damaged packaging) must also be reported in writing to Customer Service, Flokk within 7 days after receipt.

For transport damage you need to take photos and document the damage, before reporting in writing to Customer Service, Flokk.

Please document:

- Photo of Flokk product label (including order no.)
- Photo of damaged goods
- Photo of damaged packaging
- Copy of transport document (if provided)
- Short description of claim

CHANGE/CANCELLATION OF ORDERS

Change/cancellation of orders on chairs or upholstery are possible up until production has begun. Changes made 2 days after receiving the order confirmation, each amended or cancelled order will incur a charge per order (see below).

Once production has started orders cannot be changed. Change of orders within the HÅG Quick-ship collection are not possible.

Each amended or cancelled order will incur a charge:

- Amended order (all changes & cancellations) before production start will incur a charge of 500 DKK per order
- Amended order & cancellations after purchasing has started will incur a charge of 750 DKK per order + cost of materials

For further information regarding change/cancellation of orders, please feel free to contact Customer Service, Flokk A/S.

HÅG WARRANTY

General terms and conditions

Flokk's warranty covers all HÅG chairs against material and manufacturing faults and defects from the chair's production date. The warranty covers any necessary spare parts. Labour and transport costs are not covered. Wear and tear must be expected from normal use and are not covered by the warranty. Unless otherwise is specified, the maximum weight for users is 110 kg. The warranty is conditional on the chair and fabrics/leather undergoing normal cleaning. The warranty does not cover the consequence of wear and stains when choosing a light (white) colour for upholstery, plastic or metal components.

10 year warranty for HÅG products and accessories

Flokk provides a 10 year warranty for all HÅG chairs and accessories that are in normal use for up to 9 hours per day. Please also see the general warranty terms and conditions.

24/7 – 5 year warranty

Flokk provides a 5 year warranty for HÅG chairs that are specifically purchased for 24 hour use and which are upholstered in 24/7 approved fabric/leather from Flokk's Standard & Extended Collection. Please also see the general warranty terms and conditions.

>9 hours/day – 5 year warranty

Flokk provides a 5 year warranty for all HÅG chairs that are in normal use for more than 9 hours per day. Please also see the general warranty terms and conditions.

Spare parts guarantee

Flokk guarantees the delivery of spare parts for a minimum of 10 years after the chair's production date. The guarantee covers the parts necessary to maintain the chair's original functionality.

FABRIC AND COLOUR COLLECTION

Standard Fabric & Colour collection

Flokk provides a 10 year warranty for fabrics/leather from the Standard collection when the chair is in normal use for up to 9 hours per day, except Illusion and PUxx1 where Flokk provides 5 year warranty. Flokk provides a 5 year warranty for fabrics/ leather from the Standard collection when the chair is in normal use for more than 9 hours per day, except for Illusion and PUxx1 where a 2 year warranty is provided.

Curated Fabric & Colour collection

Flokk provides a 10 year warranty for fabrics from the Curated collection when the chair is in normal use for up to 9 hours per day. Flokk provides a 5 year warranty for fabrics from the Curated collection when the chair is in normal use for more than 9 hours per day.

Extended Fabric & Colour collection

Flokk provides a 5 year warranty for fabrics/leather from the Extended collection when the chair is in normal use for up to 9 hours per day. Some of the fabrics in the Extended collection are available with a 5 year warranty for 24 hour use (for use of more than 9 hours per day).

On request fabrics/leather

If the fabrics in the Standard, Curated or Extended collections are not what you are looking for, please contact Customer Service at Flokk, email: info-dk@flokk.com. When choosing "On request" fabric/leather the general warranty terms and conditions are still valid, except for the upholstery which will be without any warranty. This does not affect your rights and obligations under local law. "On request" fabrics/leather can only be used following approval by Flokk.

Fabrics and leathers that are not tested on our products, need to have an upholstery test before we can approve it and the order can be registered. Cost (DKK 1.545) for testing will be charged.

MAINTENANCE GUIDE

Care of fabric upholstery

Regular vacuum cleaning is recommended. Vacuum clean the chair with a furniture brush or wipe it with a clean white cloth or sponge slightly dampened with lukewarm, clean water. Marks and stains should be removed with a proprietary cleaner.

Care of leather upholstery

Wipe with a slightly damp cloth and gently rub dry. A good proprietary hide food should be applied at least once a year and more often if the leather is in a dry atmosphere or close to a heat-source.

Do not remove any plastic parts or attempt to open the seating mechanism. For additional maintenance advice please contact our customer service team or our web site flokk.com.

Care of gas stem

Gas stems should be periodically wiped clean with a cloth and general purpose solvent, then a fingertip of light grease applied.

APPROVALS AND CERTIFICATIONS

Flokk is ISO 9001 accredited. The German test institutes, LGA and Intertek, have approved and issued the GS certificate (Geprüfte Sicherheit) for a number of HÅG products.

- The majority of HÅG task chairs are tested in accordance with both EN 1335 Type A (European office chair standard) and ANSI Bifma (American standard).
- The majority of HÅG conference and visitor chairs are tested in accordance with EN 16139 and the ANSI Bifma standard.
- HÅG SoFi, HÅG Futu and HÅG executive are tested according to British Standard BS 5459-2, a commonly used standard for intensive use (24 hours).

EN 1335 is a European Standard for office chairs and considers dimensions of the chair, safety requirements and safety test methods. The European Standard tests are based on 8 hours daily use by persons weighing up to 110 kg.

The British Standard (BS 5459-2) tests that the chair will be suitable for more than 8 hours daily use and for persons weighing up to 150 kg

The majority of HÅG products are certified with the Swedish Möbelfakta and GREENGUARD Gold, while a selection of HÅG products are certified with the Nordic Swan Ecolabel.

DISCLAIM

Flokk disclaims any responsibility for products that are configured or assembled in a different way than Flokk's official configurations. That is, as a result of component purchases, special orders or the like.

ESD (ELECTROSTATIC DISCHARGE)

We can supply HÅG Creed 6002, HÅG Creed 6004, HÅG Capisco Puls 8001/8010 and HÅG Capisco 8106 as ESD chairs upholstered in anti-static synthetic leather (Nevotex) or Hi-Tech (Camira) Black AS064 in price group 6 +10%.

Flokk provides a 5 year warranty on ESD chairs, conditional on castors and upholstery being cleaned regularly with a suitable cleaning agent. The ESD models are only available in silver painted aluminium. The ESD models are always delivered fully assembled.

CLEAN-ROOM

We can supply HÅG models with vinyl that are suitable for areas that need to be regularly cleaned. Please contact Customer Service for further information. HÅG Capisco Puls 8010 upholstered in anti-static synthetic leather by Nevotex (price group 3) approves an air cleanliness test according to ISO 14644, class 4-5. Flokk provides a 5 year warranty on clean-room chairs, conditional on castors and upholstery being cleaned regularly with a suitable cleaning agent.

HEALTHCARE

We recommend PUxx by Oniro and Illusion by Nevotex. Both are easy cleanable polyurethane based synthetic leather for use within healthcare. PUxx and Illusion are easy to disinfect with alcohol, chlorine or hydrogen peroxide solutions. PUxx1 colour 215816 is available as standard in price group 3 and Illusion colour 110 is available as standard in price group 4. PUxx is not available for HÅG Conventio 9510, 9511 & 9512.

FIRE RESISTANCE FOAM

On request. Please contact our customer service for further information.

ENVIRONMENTAL RESPONSIBILITY

Environmental considerations on our products and the manufacturing of our products are at the heart of our business. Flokk is thus certified in accordance with ISO 14001:2015 environment and ISO 50001:2018 energy management systems. Most of the materials used in HÅG products can be recycled if handled properly. A complete material composition for each HÅG product is available on request.

PACKAGING MATERIAL - RECYCLING



We encourage you to ensure recycling of all packaging material. Please sort and return the packaging material, using your local recycling partners/stations - and follow your local regulations. If you have questions on how to handle waste packaging material, please inform your contact person within Flokk.

END OF LIFE - RECYCLING

We encourage you to ensure proper recycling of your chair and its various components. Please dispose of your chair/components using your local recycling partners/stations - and follow your local regulations. If you have questions on how to dispose or return your chair after use, please inform your contact person within Flokk.

HÅG SoFi® - task chairs

- HÅG inBalance® (balanced, flowing tilt function backwards and forwards)
- Seat depth adjustment
- Seat height adjustment
- Adjustable lumbar support
- Adjustable tilting resistance forwards and backwards
- Lockable tilt
- Five star aluminium base (730 mm): Black, silver or white, optionally in polished aluminium. Mechanism cover is black when ordering black base. It's light grey when ordering silver or white base. Please specify when placing your order
- Castors for hard or soft flooring. Must be specified at time of order
- 150 mm lift (seat height: 393-546 mm)
- Painted aluminium colours: Black, white or silver
- Plastic colours: Black (recycled PP) or light grey

Item no	Base model +	Price Group (PG)	①	②	③	④	⑤	⑥	⑦	Price
7500	HÅG SoFi mesh 7500 <ul style="list-style-type: none"> • Mesh back: The mesh back comes in black (MEH001) or grey (MEH002) • High back 		7 872	8 089	8 451	8 876	9 288	10 563	12 358	
7200	HÅG SoFi 7200 <ul style="list-style-type: none"> • Fully upholstered back • Medium back 		7 872	8 089	8 451	8 876	9 288	10 563	12 358	
7300	HÅG SoFi 7300 <ul style="list-style-type: none"> • Fully upholstered back • High back 		8 380	8 603	8 983	9 432	9 861	11 185	13 087	
Accessories/Options/Surcharges:										
	Headrest HÅG SoFi		1 924	1 964	2 034	2 114	2 193	2 522	2 950	
	Adjustable armrests in plastic with soft tops (black or light grey) (width 92 mm) and stem in painted aluminium (black, white or silver)									1 729
	- Surcharge for armrests and stem in painted aluminium (black, white or silver) with soft tops (black or light grey) (width 102 mm)									332
	- Surcharge for armrests in black plastic with soft tops (width 92 mm) and stem in polished aluminium									1 328
	- Surcharge for armrests and stem in polished aluminium with soft tops (width 102 mm)									1 660
	- Surcharge for black leather tops (available for armrests in aluminium) (width 102 mm)									738
	- Surcharge for HÅG SlideBack (available for all armrests) *									429

Accessories/Options/Surcharges:

	- Surcharge for 3D tops (available for armrests in plastic) *	427
LI002	200 mm lift	114
CA004	Glides	0
FB030	Five star base (Ø730 mm) in polished aluminium	724
	Coat hanger, black or light grey plastic. Not applicable with headrest. (Only for: 7500)	454
	Decorative stitching	915
169121	HÅG FootRing (Ø450 mm) - Black, Silver or White. Must be ordered together with 200 mm lift	1128
165134	HÅG Quickstep, 1 pcs	1076

* Required for HÅG SoFi according to NPR 1813

NB: PRICES MAY VARY WHEN OPTIONS ARE PURCHASED SEPARATELY FROM COMPLETE CHAIRS

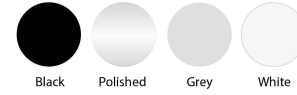
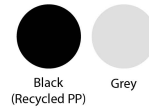

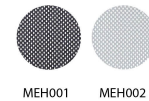

Mesh, Palmhive



HÅG SoFi® - communication chair

- HÅG inBalance® (balanced, flowing tilt function backwards and forwards)
- Seat depth adjustment
- Seat height adjustment
- Lumbar support
- 4 star base in aluminium (Ø785 mm): Black, silver or white, optionally in polished aluminium. Mechanism cover is black when ordering black base and light grey when ordering silver or white base. Please specify when placing your order
- Plastic glides for soft flooring or felt glides for hard flooring. Must be specified at time of order
- 150 mm lift (seat height: 393-546 mm)
- Painted aluminium colours: Black, white or silver
- Plastic colours: Black (recycled PP) or light grey

Item no	Base model +	Price Group (PG)	Price Group							Price
			①	②	③	④	⑤	⑥	⑦	
7502	HÅG SoFi mesh 7502 • Mesh back: The mesh back comes in black MEH001 or grey MEH002. • High back		6 272	6 408	6 633	6 894	7 153	8 225	9 623	
7202	HÅG SoFi 7202 • Fully upholstered back • Medium back		6 272	6 408	6 633	6 894	7 153	8 225	9 623	
7302	HÅG SoFi 7302 • Fully upholstered back • High back		6 874	7 017	7 263	7 555	7 836	9 011	10 544	
Accessories/Options/Surcharges:										
	Adjustable armrests in plastic with soft tops (black or light grey) (width 92 mm) and stem in painted aluminium (black, white or silver)									1 729
	- Surcharge for armrests and stem in painted aluminium (black, white or silver) with soft tops (black or light grey) (width 102 mm)									332
	- Surcharge for armrests in black plastic with soft tops (width 92 mm) and stem in polished aluminium									1 328
	- Surcharge for armrests and stem in polished aluminium with soft tops (width 102 mm)									1 660
	- Surcharge for black leather tops (available for armrest in aluminium) (width 102 mm)									738
FB039	Four star base (Ø785 mm) in polished aluminium									724
FB022	Five star base (Ø730 mm) in aluminium - silver/black/white									0
FB030	Five star base (Ø730 mm) in polished aluminium									724
	Decorative stitching									915

NB: PRICES MAY VARY WHEN OPTIONS ARE PURCHASED SEPARATELY FROM COMPLETE CHAIRS





Decorative stitching is available for all models, but only for the seat on HÅG SoFi with mesh back.



Photo: Jonas Lindström
Location: Juvet Landskapshotell, Valldal, Norway

HÅG Capisco® - task chair

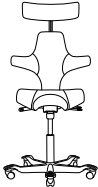
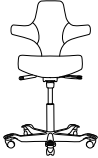
- HÅG inBalance® (balanced, flowing tilt function)
- Adjustable tilt tension backwards (not available for 8105)
- Seat height adjustment
- Seat depth adjustment (not available for 8105)
- Back height adjustment (not available for 8105)
- Lockable seat (not available for 8105)
- Suitable for all working surfaces with table height of 72 cm and higher
- Five star base in aluminium (Ø730 mm) with curved/arched footplates, Black, Silver or White, optionally in polished aluminium. NEW colours available Q2: Blush Rose and Moss Grey. Please specify colour at time of order.
- 200 mm lift (seat height: 470-655 mm). 265 mm lift standard for 8105 (seat height: 530-790 mm)

Item no	Base model +	Price Group (PG)	Price Group							Price
			①	②	③	④	⑤	⑥	⑦	
8105	HÅG Capisco 8105 • 265 mm lift		4 208	4 284	4 488	4 707	4 918	5 514	6 451	
8106	HÅG Capisco 8106 • Available as electrostatic discharged (ESD) chair (PG 6 + 10%) • 200 mm lift		10 620	10 819	11 324	11 654	12 178	13 483	15 776	
8107	HÅG Capisco 8107 • Headrest (only available in Silver and Black paint) • 200 mm lift		12 721	13 071	13 718	14 232	14 995	16 900	19 772	
8126	HÅG Capisco 8126 • 200 mm lift		10 620	10 819	11 324	11 654	12 178	13 483	15 776	
8127	HÅG Capisco 8127 • Headrest (only available in Silver and Black paint) • 200 mm lift		12 721	13 071	13 718	14 232	14 995	16 900	19 772	

Accessories/Options/Surcharges:

LI001	150 mm lift	0
LI002	200 mm lift for 8105	0
LI003	265 mm lift (glides are recommended, no additional charge) for 8106, 8107, 8126 & 8127	105
CA004	Glides	0
EL001	Telescopic lift cover (200mm & 265mm). Black	93
FB035	Five star base (Ø730 mm) in polished aluminium	865
CA016	Universal castors Ø65 mm, for hard and soft floors, black	85
169121	HÅG FootRing (Ø450 mm) Black, Silver, White, Blush Rose or Moss Grey ¹	1128
165177-1A/2A	HÅG StepUp 1 pcs - Black or Silver	1434
165134	HÅG Quickstep, 1 pcs	1076
	Decorative stitching (Only for: 8105, 8106, 8107)	915
TS004	Chair hanger HÅG Capisco (Only for: 8106, 8126)	198

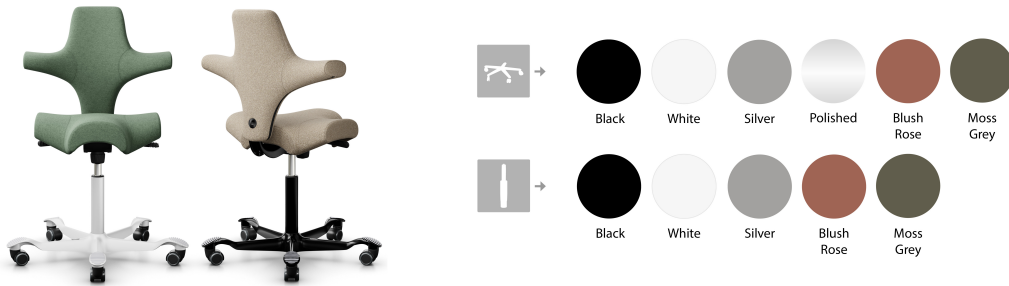

NB: PRICES MAY VARY WHEN OPTIONS ARE PURCHASED SEPARATELY FROM COMPLETE CHAIRS



[1] Must be ordered together with 200 mm or 265 mm lift.

HÅG Capisco Puls® - task chair

- HÅG inBalance® (balanced, flowing tilt function)
- Adjustable tilt tension backwards (not available for 8001 and 8002)
- Seat height adjustment
- Seat depth adjustment (not available for 8001 and 8002)
- Back height adjustment (not available for 8001 and 8002)
- Lockable seat (not available for 8001 and 8002)
- Suitable for all working surfaces with table height of 72 cm and higher
- Five star base in aluminium (Ø730 mm) with curved/arched footplates, Black, Silver or White, optionally in polished aluminium (see options on next page).
NEW colours available Q2: Blush Rose and Moss Grey
- Seat and backrest available in 9 different PP colours: Clay, Rosehip, Moss, Blueberry, Light Grey, Black (recycled PP), White, Sand and Brown*. Brown is made of recycled PP from snow plough markers - colour variations between batches may occur due to mix of black and red snow plough markers
- Please specify colour at time of order - on seat&back, five star base and lift. See colour palette on next page for possible combinations
- For ESD models, seat and back are only available in Black

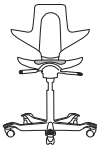
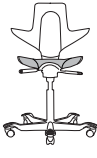
Item no	Base model +	Price Group (PG)	Price Group							Price
			①	②	③	④	⑤	⑥	⑦	
8001	<p>HÅG Capisco Puls 8001</p> <ul style="list-style-type: none"> • Pad available in all Standard Fabrics except Steelcut 3, Steelcut Trio 3, Sirdal & Suldal • Seat height: 540-770 mm • 265 mm lift • Available as electrostatic discharged (ESD) chair (PG 6 + 10 %) 		2 687	2 732	2 849	2 990	3 124	3 593	4 204	
8002	<p>HÅG Capisco Puls 8002</p> <ul style="list-style-type: none"> • Removable seat cushion available in all Standard Fabrics • Seat height: 555-785 mm • 265 mm lift 		3 584	3 661	3 789	3 914	4 060	4 668	5 463	
8010	<p>HÅG Capisco Puls 8010</p> <ul style="list-style-type: none"> • Pad available in all Standard Fabrics except Steelcut 3, Steelcut Trio 3, Sirdal & Suldal • Seat height: 455-640 mm • 200 mm lift • Available for Cleanroom upholstered in Antistatic synthetic leather • Available as electrostatic discharged (ESD) chair (PG 6 +10 %) 		3 860	3 934	4 112	4 228	4 414	5 076	5 939	
8020	<p>HÅG Capisco Puls 8020</p> <ul style="list-style-type: none"> • Removable seat cushion available in all Standard Fabrics • Seat height: 470-650 mm • 200 mm lift 		4 345	4 438	4 594	4 750	4 926	5 665	6 628	

Accessories/Options/Surcharges:

LI001	150 mm lift	0
LI002	200 mm lift for 8001 & 8002	0
LI003	265 mm lift (glides are recommended, no additional charge) for 8010 & 8020	105
EL001	Telescopic lift cover (200mm & 265mm). Black	93
FB035	Five star base (Ø730 mm) in polished aluminium	865

Accessories/Options/Surcharges:

CA016	Universal castors Ø65 mm, for hard and soft floors, black	85
CA004	Glides	0
169121	HÅG FootRing (Ø450 mm) Black, Silver, White, Blush Rose or Moss Grey ¹	1128
165177-1A/2A	HÅG StepUp 1 pcs - Black or Silver	1434
165134	HÅG Quickstep, 1 pcs	1076
TS004	Chair hanger HÅG Capisco Puls (Only for: 8010, 8020)	198

NB: PRICES MAY VARY WHEN OPTIONS ARE PURCHASED SEPARATELY FROM COMPLETE CHAIRS

Electrostatic discharged (ESD) chair: Seat and back only available in black



Matching colours for HÅG Capisco Puls

S = Standard
E = Extended

↓ → Black Recycled PP, White, Light Grey, Clay, Rosehip, Moss, Sand, Blueberry, Brown Recycled PP*

↖ → Black, White, Silver, Polished, Blush Rose, Moss Grey

↑ → Black, White, Silver, Blush Rose, Moss Grey

② Select SC60999 (S), Select SC61188 (S), Select SC60131 (S), Select SC60129 (S), Select SC64213 (S), Select SC68209 (S), Select SC62097 (S), Select SC66194 (S)





③ Mainline Flax MLF044 (E), Mainline Flax MLF018 (E), Mainline Flax MLF012 (E), Mainline Flax MLF035 (E)

*Colour variations between batches may occur

[1] Must be ordered together with 200 or 265 mm lift

HÅG® Tion - task chair

- HÅG inBalance® (balanced, flowing tilt function backwards and forwards)
- Seat height adjustment
- Lockable tilt
- Universal castors (Ø65 mm) for soft and hard flooring, black
- Five star base (Ø620 mm) with foot supports in recycled aluminium. Available in 5 colours: Black, Silver, White, Blush Rose and Moss Grey and 2 finishes: polished* and tumbled*
- 150 mm lift (seat height: 408-542 mm). Available in 5 colours: Black, Silver, White, Blush Rose and Moss Grey
- Back stem in recycled aluminium. Available in 5 colours: Black, Silver, White, Blush Rose and Moss Grey) and 2 finishes: polished* and tumbled*
- Seat and back in 94% post-consumer recycled PP or Ash with white pigmented wax. PP available in 8 colours: Black, Mist, Harvest, Moss, Blush, Chestnut, Crowberry and Brown**. Brown is made of recycled PP from snow plough markers - colour variations between batches may occur due to mix of black and red snow plough markers
- Please specify colours at time of order - on seat&back, back stem, five star base and lift. See colour palette on next page for possible combinations
- Focus collection - see below Accessories/Options. A selection of sustainable fabrics with colours from Standard and Extended collection that matches the HÅG Tion

Item no	Base model +	Price Group (PG)	Price Group							Price
			①	②	③	④	⑤	⑥	⑦	
2100	HÅG Tion 2100 • Plastic seat and back • Seat height: 408-542 mm									3799
2140	HÅG Tion 2140 • Upholstered seat and plastic back • Removable upholstery • Seat height: 408-542 mm		4 424	4 545	4 602	4 642	4 772	5 488	6 422	
2160	HÅG Tion 2160 • Upholstered seat and back • Removable upholstery • Seat height: 408-542 mm • Canvas 2, Remix 3, Paloma/Paloma Soft not available		4 983	5 090	5 268	5 479	5 681	6 534	7 643	
2200	HÅG Tion 2200 • Wooden seat and back • Seat height: 408-542 mm									7824
2240	HÅG Tion 2240 • Upholstered seat and wooden back • Removable upholstery • Seat height: 408-542 mm		6 917	7 065	7 312	7 605	7 886	9 070	10 611	

Accessories/Options/Surcharges:

	Armrests in painted aluminium. Black, Silver, White, Blush Rose or Moss Grey	708
	Armrests in tumbled aluminium *	1012
	Armrests in polished aluminium *	1212
MC022	Back stem in tumbled aluminium*	108
MC003	Back stem in polished aluminium*	473
FB055	Five star base (Ø620 mm) in tumbled aluminium*	191
FB056	Five star base (Ø620 mm) in polished aluminium*	443
	200 mm lift. Black, Silver, White, Blush Rose or Moss Grey. (Not available on chair with armrests)	96
TS005	Chair hanger HÅG Tion	155
169121	HÅG FootRing (Ø450 mm) in Black, Silver, White, Blush Rose or Moss Grey ¹	1128
165134	HÅG Quickstep, 1 pcs	1076

NB: PRICES MAY VARY WHEN OPTIONS ARE PURCHASED SEPARATELY FROM COMPLETE CHAIRS

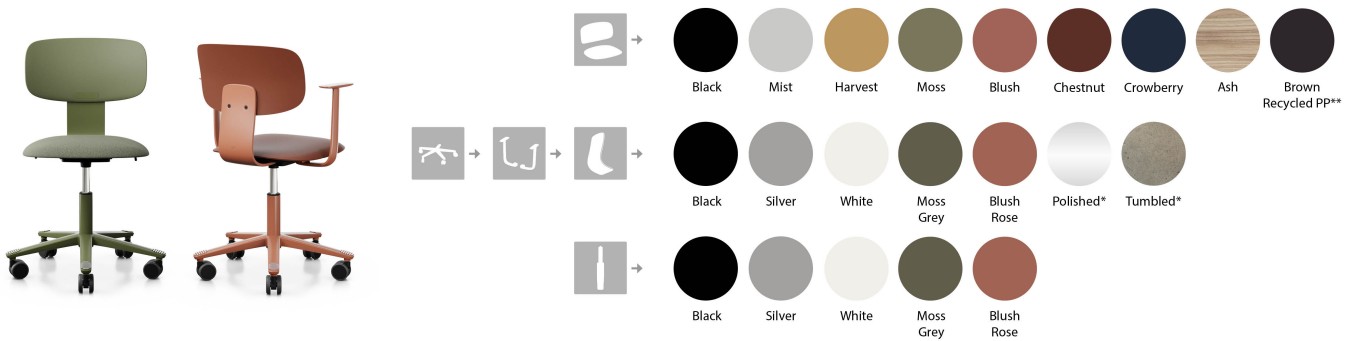

HÅG Tion - Focus collection

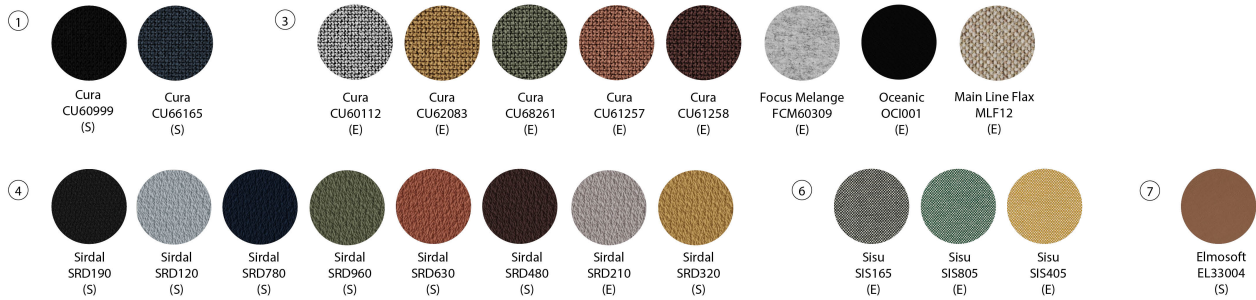





S = Standard
E = Extended

** Colour variations between batches may occur

[1] HÅG FootRing must be ordered together with 200 mm lift

HÅG Futu® - task chair

- HÅG inBalance® (balanced, flowing tilt function backwards and forwards)
- Seat depth and seat height adjustment
- Adjustable lumbar support
- Adjustable forwards and backwards tilting resistance
- Lockable tilt
- Aluminium five star base (Ø730 mm) with foot supports, Black or Silver
- 150 mm lift (Seat height: 398-551 mm)
- Painted aluminium colours: Black or Silver
- Plastic colours: Black
- 7 FutuKnit solid colours for seat and/or face of backrest on models 1100S, 1200-S and 1200. 7 matching FutuKnit mesh colours available on backrest for model 1100-S - see colour palette
- 7 FutuKnit mesh colours for backrest of models 1100/1100-S. 7 matching FutuKnit solid colours on seat available for model 1100-S - see colour palette

Item no	Base model +	Price Group (PG)	Price Group							Price
			①	②	③	④	⑤	⑥	⑦	
1100-S	HÅG Futu mesh 1100-S • FutuKnit mesh on backrest • FutuKnit solid on seat									6949
1100	HÅG Futu mesh 1100 • FutuKnit mesh on backrest • Standard or Extended fabric on seat		7 311	7 446	7 698	7 977	8 352	9 405	11 005	
1200-S	HÅG Futu 1200-S • FutuKnit solid on face of backrest • FutuKnit solid on seat • Adjustable lumbar support									6949
1200	HÅG Futu 1200 • FutuKnit solid on face of backrest • Standard or Extended fabric on seat • Adjustable lumbar support		7 311	7 446	7 698	7 977	8 352	9 405	11 005	

Accessories/Options/Surcharges:

LI002	200 mm lift	114
AR500	Adjustable armrests, black plastic	1033
AR501	Adjustable armrests with 3D top (pair) *	1696
AR502	Adjustable armrests with padded black leather top	1965
FB030	Five star base (Ø730 mm) in polished aluminium	724
FB025	Five star base (Ø670 mm) in black plastic	0

Accessories/Options/Surcharges:

CA004	Glides	0
LS100	Lumbar support (Only for: 1100-S, 1100)	331
169121	HÅG FootRing (Ø450 mm) - Black or Silver. In combination with 200 mm lift	1128
165134	HÅG Quickstep, 1 pcs	1076

NB: PRICES MAY VARY WHEN OPTIONS ARE PURCHASED SEPARATELY FROM COMPLETE CHAIRS

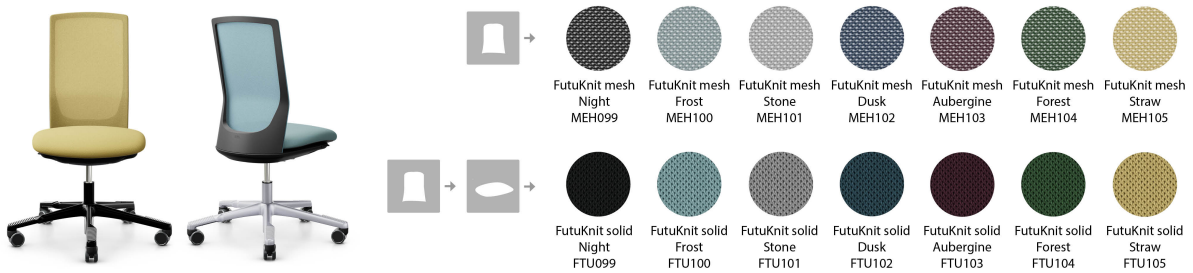

*) Required for HÅG Futu according to NPR 1813

FUTUKNIT MESH & SOLID FOR HÅG FUTU TASK AND COMMUNICATION CHAIR



HÅG Futu® - communication chair

- HÅG inBalance® (balanced, flowing tilt function backwards and forwards)
- Seat depth adjustment
- Seat height adjustment
- Aluminium four star base (Ø785 mm), Black or Silver
- 150 mm lift (Seat height: 398-551 mm)
- Painted aluminium colours: Black or Silver
- Plastic colours: Black
- 7 FutuKnit solid colours for seat on model 1102-S. 7 matching FutuKnit mesh colours available on backrest - see colour palette previous page
- 7 FutuKnit mesh colours for backrest. 7 matching FutuKnit solid colours on seat available for model 1102-S - see colour palette previous page

Item no	Base model +	Price Group (PG)	Price Group							Price
			①	②	③	④	⑤	⑥	⑦	
1102-S	HÅG Futu mesh 1102-S • FutuKnit mesh on backrest • FutuKnit solid on seat									5719
1102	HÅG Futu mesh 1102 • FutuKnit mesh on backrest • Standard fabric or Extended on seat		6 071	6 202	6 447	6 717	7 082	8 105	9 482	

Accessories/Options/Surcharges:

AR500	Adjustable armrests, black plastic	1033
AR502	Adjustable armrests with padded black leather top	1965
FB039	Four star base (Ø785 mm) in polished aluminium	895
FB022	Five star base (Ø730 mm) in aluminium - Silver or Black	0
FB030	Five star base (Ø730 mm) in polished aluminium	724
FB025	Five star base (Ø670 mm) in black plastic	0

NB: PRICES MAY VARY WHEN OPTIONS ARE PURCHASED SEPARATELY FROM COMPLETE CHAIRS



HÅG executive collection - Fabrics and Colours

The HÅG executive collection consists of three exclusive product families; HÅG Tribute, HÅG Inspiration and HÅG Excellence. They all include a vast range of features and upholstery that are further explained on the following pages.



HÅG Tribute



HÅG Inspiration



HÅG Excellence

FABRICS

PLAINTECH (SR-WEBATEX)

Used on the rear side of the backrest on HÅG Excellence 9321 and 9331 and HÅG Excellence meeting 9373

Composition:	100 % polyamide
Flammability:	BS EN 1021: 1-2 (Cigarette & match)

SPACE

Space (Gabriel), used on the back of HÅG executive task chairs: HÅG Inspiration 9221 and 9231 and the HÅG Inspiration meeting 9273. This innovative textile is self-supportive, which gives new possibilities regarding product design as well as becoming an important part of the sitting experience.

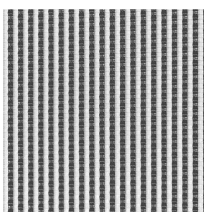
SPACE	
Composition:	100 % polyester monofilament
Abrasion and tear-strength:	2469N x 11083N support strength
Flammability:	BS EN 1021: 1-2 (Cigarette & match), FAR 25.853, DIN 4104 - B1 and B2, BS 5852 P 2 Crib5
Environmental facts:	ISO 14001 certified
Colour:	 Space, SPA 000

For all the above mentioned fabrics the following guarantee and maintenance apply:

- Guarantee: 10 years, 5 years for 24/7 use.
- Maintenance: To be vacuumed with a furniture brush, wiped with a clean damp cloth or sponge slightly dampened with clean lukewarm water.



HÅG executive collection - Fabrics and Colours continued

We offer 4 predefined configurations for the HÅG Executive range:



HÅG Tribute 9031

ALL BLACK (standard - MC017)

- Black aluminium foot base - 1
- Black lift cover - 2
- Black armrests - 3
- Black lower part of armrests - 4
- Black lumbar wheel - 5
- Black ring/cover for lumbar wheel - 6
- Black Headrest stem cover - 8
- Black headrest stem - 7
- Black spine - 9
- Black upper and lower back bars - 10



HÅG Excellence 9321



HÅG Tribute 9031

BLACK FOOTBASE WITH DETAILS IN POLISHED AND BLACK ALUMINIUM (option - MC019)

- Black aluminium foot base - 1
- Polished lift cover - 2
- Polished armrests - 3
- Polished ring/cover for lumbar wheel - 6
- Polished headrest stem cover - 8
- Black lower part of armrests - 4
- Black lumbar wheel - 5
- Black headrest stem - 7
- Black spine - 9
- Black upper and lower back bars - 10



HÅG Excellence 9321



HÅG Tribute 9031

POLISHED FOOTBASE WITH DETAILS IN POLISHED AND BLACK ALUMINIUM (option - MC020)

- Polished aluminium foot base - 1
- Black lift cover - 2
- Black lower part of armrests - 4
- Black lumbar wheel - 5
- Black headrest stem cover - 8
- Black spine - 9
- Polished armrests - 3
- Polished ring/cover for lumbar wheel - 6
- Polished headrest stem - 7
- Polished upper and lower back bars - 10



HÅG Inspiration 9221



HÅG Tribute 9031

ALL POLISHED (option - MC018)

- Polished aluminium foot base - 1
- Polished lift cover - 2
- Polished armrests - 3
- Polished lumbar wheel - 5
- Polished ring/cover for lumbar wheel - 6
- Polished Headrest stem cover - 8
- Polished Headrest stem - 7
- Polished upper and lower back bars - 10
- Black lower part of armrests - 4
- Black spine - 9



HÅG Inspiration 9221

HÅG® Tribute - task chair

- HÅG inBalance® (balanced, flowing tilt function backwards and forwards)
- Adjustable forwards and backwards tilt resistance
- Seat height adjustment
- Seat depth adjustment
- Adjustable lumbar support on all models
- Tilt lockable in three positions
- HÅG TiltDown™ armrests (tilt down, height and width) with black leather top as standard. Optionally matching leather top for chair in leather at no additional cost. Please specify colour at time of order.
- Five star base (Ø740 mm) with sloping footplates, in matt black aluminium
- All aluminium components are standard black. Optionally 3 combinations are available. Please see specifications at previous HÅG executive collection pages and please specify colour at time of order.
- 150 mm lift (seat height: 387 - 525 mm).

Item no	Base model +	Price Group (PG)	①	②	③	④	⑤	⑥	⑦	Price
9021	HÅG Tribute 9021 • Extra comfort layer gives a more loose upholstery		16 018	16 361	16 933	17 219	18 261	21 002	24 573	
9031	HÅG Tribute 9031 • Adjustable headrest • Extra comfort layer gives a more loose upholstery		18 845	19 248	19 923	20 720	21 484	24 709	28 908	

Accessories/Options/Surcharges:

LI002	200 mm lift									186
AR000	Without armrests									- 3 775
AR319	HÅG Executive Basic armrests (with height and width adjustment)									- 1 977
MC018	All polished aluminium - includes polished base FB018									1 377
MC019	Mix of black foot base and details in polished and black painted aluminium									334
MC020	Mix of polished foot base and details in polished and black painted aluminium									1 162
FB018	Five star base (Ø740 mm), in polished aluminium									853
AE313	Coathanger black (Only for: 9031)									501
AE314	Coathanger polished (Only for: 9031)									607
CA016	Universal castors Ø65 mm, for hard and soft floors, black									85

NB: PRICES MAY VARY WHEN OPTIONS ARE PURCHASED SEPARATELY FROM COMPLETE CHAIRS

HÅG® Tribute - meeting chair

- HÅG inBalance® (balanced, flowing tilt function backwards and forwards)
- Seat height adjustment
- Adjustable back cushion (lumbar)
- Swivel
- Adjustable tilting resistance backwards
- Five star base (Ø650 mm) with sloping footplates, in matt black aluminium
- All aluminium components are standard black. Optionally 3 combinations are available. Please see specifications at previous HÅG executive collection pages and please specify colour at time of order.
- 150 mm lift (seat height: 385-520 mm)

Item no	Base model +	Price Group (PG)	Price Group							Price
			①	②	③	④	⑤	⑥	⑦	
9073	HÅG Tribute 9073 • Fully upholstered back • Extra comfort layer gives a more loose upholstery		8 789	8 978	9 293	9 663	10 022	11 523	13 482	



Accessories/Options/Surcharges:

AR319	HÅG Executive Basic armrests (with height and width adjustment)	1 812
MC018	All polished aluminium - includes polished base FB020/FB039	1 377
MC019	Mix of black foot base and details in polished and black painted aluminium	334
MC020	Mix of polished foot base and details in polished and black painted aluminium	1 162
FB020	Five star base (Ø650 mm) in polished aluminium	854
FB038	Four star base (Ø785 mm) in painted aluminium (black)	- 370
FB039	Four star base (Ø785 mm) in polished aluminium	376
CA016	Universal castors Ø65 mm, for hard and soft floors, black	85

NB: PRICES MAY VARY WHEN OPTIONS ARE PURCHASED SEPARATELY FROM COMPLETE CHAIRS

HÅG® Excellence - task chair

- HÅG inBalance® (balanced, flowing tilt function backwards and forwards)
- Adjustable forwards and backwards tilt resistance
- Seat height adjustment
- Seat depth adjustment
- Adjustable lumbar support on all models
- Tilt lockable in three positions
- HÅG TiltDown™ armrests (tilt down, height and width) with black leather top as standard. Optionally matching leather top for chair in leather at no additional cost. Please specify colour at time of order
- Five star base (Ø740 mm) with sloping footplates, in matt black aluminium
- All aluminium components are standard black. Optionally 3 combinations are available. Please see specifications at previous HÅG executive collection pages and please specify colour at time of order.
- 150 mm lift (seat height: 387-525 mm)

Item no	Base model +	Price Group (PG)	⑥	⑦	Price
9321	HÅG Excellence 9321 <ul style="list-style-type: none"> • Rear of backrest is upholstered in black Plaintech • Seat and back available in Paloma Soft (PG 6) or Elmosoft (PG 7) 		24 753	28 961	
9331	HÅG Excellence 9331 <ul style="list-style-type: none"> • Adjustable headrest • Rear of backrest is upholstered in black Plaintech • Seat and back available in Paloma Soft (PG 6) or Elmosoft (PG 7) 		29 666	34 708	
Accessories/Options/Surcharges:					
LI002	200 mm lift				186
AR000	Without armrests				- 3 775
AR319	HÅG Executive Basic armrests (with height and width adjustment)				- 1 977
MC018	All polished aluminium - includes polished base FB018				1 377
MC019	Mix of black foot base and details in polished and black painted aluminium				334
MC020	Mix of polished foot base and details in polished and black painted aluminium				1 162
FB018	Five star base (Ø740 mm), in polished aluminium				853
AE312	Coathanger, black stained wood				478
CA016	Universal castors Ø65 mm, for hard and soft floors, black				85

NB: PRICES MAY VARY WHEN OPTIONS ARE PURCHASED SEPARATELY FROM COMPLETE CHAIRS

HÅG® Excellence - meeting chair

- HÅG inBalance® (balanced, flowing tilt function backwards and forwards)
- Seat height adjustment
- Adjustable back cushion (lumbar)
- Swivel
- Adjustable tilting resistance backwards
- Five star base (Ø650 mm) with sloping footplates, in matt black aluminium
- All aluminium components are standard black. Optionally 3 combinations are available. Please see specifications at previous HÅG executive collection pages and please specify colour at time of order.
- 150 mm lift (seat height: 385-520 mm)

Item no	Base model +	Price Group (PG)	⑥	⑦	Price
9373	HÅG Excellence 9373 <ul style="list-style-type: none"> • Rear of backrest is upholstered in black Plaintech • Seat and back available in Paloma Soft (PG 6) or Elmosoft (PG 7) 		16 559	19 374	

Accessories/Options/Surcharges:

AR319	HÅG Executive Basic armrests (with height and width adjustment)	1 812
MC018	All polished aluminium - includes polished base FB020/FB039	1 377
MC019	Mix of black foot base and details in polished and black painted aluminium	334
MC020	Mix of polished foot base and details in polished and black painted aluminium	1 162
FB020	Five star base (Ø650 mm) in polished aluminium	854
FB038	Four star base (Ø785 mm) in painted aluminium (black)	- 370
FB039	Four star base (Ø785 mm) in polished aluminium	376
CA016	Universal castors Ø65 mm, for hard and soft floors, black	85

NB: PRICES MAY VARY WHEN OPTIONS ARE PURCHASED SEPARATELY FROM COMPLETE CHAIRS

HÅG® Inspiration - task chair

- HÅG inBalance® (balanced, flowing tilt function backwards and forwards)
- Adjustable forwards and backwards tilt resistance
- Seat height adjustment
- Seat depth adjustment
- Adjustable lumbar support on all models
- Tilt lockable in three positions
- HÅG TiltDown™ armrests (tilt down, height and width) with black leather top as standard. Optionally matching leather top for chair in leather at no additional cost. Please specify colour at time of order
- Five star base (Ø740 mm) with sloping footplates, in matt black aluminium
- All aluminium components are standard black. Optionally 3 combinations are available. Please see specifications at previous HÅG executive collection pages and please specify colour at time of order.
- 150 mm lift (seat height: 387-525 mm)

Item no	Base model +	Price Group (PG)	②	③	④	⑤	⑥	⑦	Price
9221	HÅG Inspiration 9221 <ul style="list-style-type: none"> • Back in Space (dark) • Seat and cushion available in PG2 - PG7 		14 410	14 932	15 380	15 949	16 739	19 584	
9231	HÅG Inspiration 9231 <ul style="list-style-type: none"> • Adjustable headrest • Back in Space (dark) • Seat and cushion available in PG2 - PG7 		16 983	17 599	18 127	18 798	22 745	26 613	

Accessories/Options/Surcharges:

LI002	200 mm lift	186
AR000	Without armrests	- 1977
AR319	HÅG Executive Basic armrests (with height and width adjustment)	- 1977
MC018	All polished aluminium - includes polished base FB018	1377
MC019	Mix of black foot base and details in polished and black painted aluminium	334
MC020	Mix of polished foot base and details in polished and black painted aluminium	1162
FB018	Five star base (Ø740 mm), in polished aluminium	853
AE312	Coathanger, black stained wood	478
CA016	Universal castors Ø65 mm, for hard and soft floors, black	85

NB: PRICES MAY VARY WHEN OPTIONS ARE PURCHASED SEPARATELY FROM COMPLETE CHAIRS

HÅG® Inspiration - meeting chair

- HÅG inBalance® (balanced, flowing tilt function backwards and forwards)
- Seat height adjustment
- Adjustable back cushion (lumbar)
- Swivel
- Adjustable tilting resistance backwards
- Five star base (Ø650 mm) with sloping footplates, in matt black aluminium
- All aluminium components are standard black. Optionally 3 combinations are available. Please see specifications at previous HÅG executive collection pages and please specify colour at time of order.
- 150 mm lift (seat height: 385-520 mm)

Item no	Base model +	Price Group (PG)	②	③	④	⑤	⑥	⑦	Price
9273	HÅG Inspiration 9273 • Back in Space (dark). • Seat and cushion available in PG2 - PG7		10 676	11 064	10 997	11 404	12 991	15 200	





Accessories/Options/Surcharges:

AR319	HÅG Executive Basic armrests (with height and width adjustment)	1 812
MC018	All polished aluminium - includes polished base FB020/FB039	1 377
MC019	Mix of black foot base and details in polished and black painted aluminium	334
MC020	Mix of polished foot base and details in polished and black painted aluminium	1 162
FB020	Five star base (Ø650 mm) in polished aluminium	854
FB038	Four star base (Ø785 mm) in painted aluminium (black)	- 370
FB039	Four star base (Ø785 mm) in polished aluminium	376
CA016	Universal castors Ø65 mm, for hard and soft floors, black	85

NB: PRICES MAY VARY WHEN OPTIONS ARE PURCHASED SEPARATELY FROM COMPLETE CHAIRS

HÅG Creed® - task chair

- HÅG inBalance® (balanced, flowing tilt function backwards and forwards)
- 4 in 1 adjustment: Seat depth, back height and forward and backward tilt tension in one wheel
- Adjustable seat height
- Possibility to adjust backrest separately
- Lockable in three positions
- Five star base (Ø730 mm) in aluminium with curved/arched footplates, standard in black or silver, optionally in polished aluminium.
- Please specify colour at time of order
- 150 mm lift

Item no	Base model +	Price Group (PG)	Price Group							Price
			①	②	③	④	⑤	⑥	⑦	
6002	HÅG Creed 6002 <ul style="list-style-type: none"> • Fully upholstered back • Low back • Seat height: 395-535 mm • Available as electrostatic discharged (ESD) chair (PG 6 +10%). Headrest and armrests are not available for ESD chair • Available with shorter seat: SHORT* (no additional charge) 		7 326	7 572	7 776	8 430	8 712	10 168	11 895	
6003	HÅG Creed 6003 <ul style="list-style-type: none"> • Partially upholstered back • Medium back • Seat height: 395-535 mm 		7 896	8 058	8 230	8 842	9 111	10 476	12 256	
6004	HÅG Creed 6004 <ul style="list-style-type: none"> • Fully upholstered back • Medium back • Seat height: 395-535 mm • Available as electrostatic discharged (ESD) chair (PG 6 +10%). Headrest and armrests are not available for ESD chair • Available with shorter seat: SHORT* (no additional charge) 		8 131	8 510	8 712	9 415	9 694	11 319	13 242	
6005	HÅG Creed 6005 <ul style="list-style-type: none"> • Partially upholstered back • High back • Seat height: 395-535 mm 		8 318	8 487	8 659	9 282	9 539	10 945	12 805	
6006	HÅG Creed 6006 <ul style="list-style-type: none"> • Fully upholstered back • High back • Seat height: 395-535 mm • Available with shorter seat: SHORT* (no additional charge) 		8 532	8 959	9 122	9 841	10 139	11 932	13 959	

Item no	Base model +	Price Group (PG)	Price Group							Price
			①	②	③	④	⑤	⑥	⑦	
6056	HÅG Creed 6056 Comfort • Fully upholstered back w/extra soft comfort • High back • Seat height: 405-545 mm		10 082	10 588	10 780	11 629	11 981	14 100	16 496	

Accessories/Options/Surcharges:

	Headrest HÅG Creed	2 001	2 402	2 658	3 064	3 497	4 527	5 297	
LI005	200 mm lift								18
LI006	265 mm lift (glides are recommended, no additional charge)								116
AR218	Adjustable armrest								1 234
AR217	- Surcharge for armrests with 3D-top *								878
EA002	- Surcharge for HÅG SwingBack® armrests								997
FB035	Five star base (Ø730 mm) in polished aluminium								848
CA016	Universal castors Ø65 mm, for hard and soft floors, black								85
CA004	Glides								0
169121	HÅG FootRing (Ø450 mm) - Black or Silver ¹								1 128
165177-1A/2A	HÅG StepUp 1 pcs								1 434
165134	HÅG Quickstep, 1 pcs								1 076



NB: PRICES MAY VARY WHEN OPTIONS ARE PURCHASED SEPARATELY FROM COMPLETE CHAIRS

*) SHORT: Shorter seat available for model 6002, 6004 and 6006 (400 mm seat pad depth). To achieve "Class AX" certification, both SHORT and armrests with 3D-top must be added

[1] HÅG FootRing must be ordered together with 200 or 265 mm lift

HÅG Creed® - communication chair

- HÅG inBalance® (balanced, flowing tilt function backwards and forwards)
- Glides for hard or soft flooring need to be specified at time of order

Item no	Base model +	Price Group (PG)	①	②	③	④	⑤	⑥	⑦	Price
6071	HÅG Creed 6071 • DISCONTINUED DURING 2024 • Sledge base in steel: Black or silver • Seat height: 445 mm		4 485	4 578	4 714	4 899	5 081	5 860	6 856	
6172	HÅG Creed 6172 • 20 mm thicker seat than 6071 for extra comfort • Adjustable seat height • Aluminium 5 star base (Ø730 mm) w/footplates: Black or silver • 150 mm lift • Seat height: 405-545 mm		4 816	4 916	5 061	5 258	5 455	6 290	7 359	



Accessories/Options/Surcharges:

AR111	Armrests in aluminium. Silver or black	997
FB035	Five star base (Ø730 mm) in polished aluminium (Only for: 6172)	848
CA016	Universal castors Ø65 mm, for hard and soft floors, black (Only for: 6172)	85

NB: PRICES MAY VARY WHEN OPTIONS ARE PURCHASED SEPARATELY FROM COMPLETE CHAIRS

HÅG H03® - task chair

- HÅG inBalance® (balanced, flowing tilt function backwards and forwards)
- Seat height adjustment
- Combined adjustment of back height and seat depth
- Five star base (Ø686 mm) in plastic with sloping footplates
- 150 mm lift (seat height: 412-551 mm)

Item no	Base model +	Price Group (PG)	①	②	③	④	⑤	⑥	⑦	Price
330	HÅG H03 330 <ul style="list-style-type: none"> • Low back • Removable upholstery on seat and back • Back bar and arm slides in aluminium: Black or silver 		5 124	5 245	5 581	5 867	6 222	6 839	8 002	
340	HÅG H03 340 <ul style="list-style-type: none"> • Medium back • Removable upholstery on seat and back • Back bar and arm slides in aluminium: Black or silver • Individual tilt tension adjustment 		5 702	5 819	6 162	6 460	6 969	7 311	8 554	
350	HÅG H03 350 <ul style="list-style-type: none"> • Medium back • Fully upholstered seat and back • Back bar and arm slides in aluminium: Black or silver • Individual tilt tension adjustment 		6 561	6 695	7 037	7 494	7 864	8 781	10 274	
Accessories/Options/Surcharges:										
LI002	200 mm lift									17
LI003	265 mm lift (glides are recommended, no additional charge) ¹									119
EL001	Telescopic lift cover (200mm & 265mm). Black									93
AR001	Adjustable armrests									718
FB034	Five star base (Ø730 mm) in aluminium - silver/black									812
FB035	Five star base (Ø730 mm) in polished aluminium									1 167
CA016	Universal castors Ø65 mm, for hard and soft floors, black									85
CA004	Glides									0
169121	HÅG FootRing (Ø450 mm) - Black or Silver ²									1 128





NB: PRICES MAY VARY WHEN OPTIONS ARE PURCHASED SEPARATELY FROM COMPLETE CHAIRS

[1] 265 mm lift must be ordered together with five star base in aluminium

[2] Must be ordered together with 200 or 265 mm lift

HÅG® Celi - conference chair

- HÅG inBalance® (balanced, flowing tilt function backwards and forwards)
- 4 legs and back stems in aluminium. Available in four colours: Black, Blueberry, Blush Rose and Silver. Raw finish also available: due to the production process, lines, scratches and colour changes are natural part of this finish
- Seat and backrest in post-consumer PP or Natural Ash wooden veneer. PP available in 5 colours: Black, Crowberry, Chestnut, Slate and Brown**. PP colour tones might vary due to use of recycled material. Brown is made of recycled PP from snow plough markers - colour variations between batches may occur due to mix of black and red snow plough markers
- Please specify colour at time of order
- Seat height: 440 mm
- Stackable: 12-15 chairs
- Hard glides for soft flooring is standard. Felt glides for hard flooring is optional and need to be specified at time of order - see accessories. Glides follow colour of the chair legs

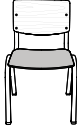
Item no	Base model +	Price Group (PG)	Price Group							Price
			①	②	③	④	⑤	⑥	⑦	
9100	HÅG Celi 9100 • Plastic seat and back									2 168
9140	HÅG Celi 9140 • Removable upholstery on seat • Plastic back		2 733	2 808	2 863	2 914	2 996	3 115	3 613	
9160	HÅG Celi 9160 • Removable upholstery on seat and back		3 313	3 407	3 516	3 719	3 922	4 462	5 206	
9200	HÅG Celi 9200 • Wooden veneer seat and back									2 693
9240	HÅG Celi 9240 • Removable upholstery on wooden veneer seat • Wooden veneer back		3 258	3 334	3 388	3 440	3 521	3 641	4 138	

Accessories/Options/Surcharges:

AR430	Armrests in aluminium. Colour follows chair legs: Black, Blueberry, Blush Rose, Silver and Raw*	333
CG002	Felt glides for hard flooring (4 units)	50
AE409	Connection device HÅG Celi - cannot be combined with armrests	95
TH001	Chair hanger HÅG Celi	155
149285	Chair trolley	2 909

NB: PRICES MAY VARY WHEN OPTIONS ARE PURCHASED SEPARATELY FROM COMPLETE CHAIRS

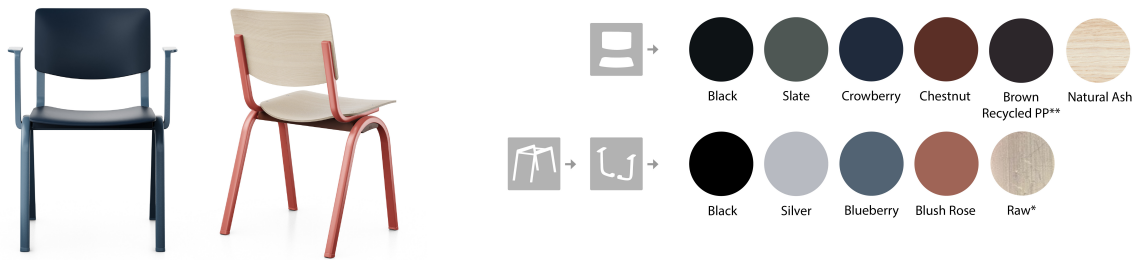

*) Raw finish: due to the production process, lines, scratches and colour changes are natural part of this finish

**) Colour variations between batches and/or minor visual imperfections may occur on some surface areas

CeliKnit (Gabriel) Price Group 3

Celiknit is a 3D shape-knitted upholstery, specially made to fit the back and seat of HÅG Celi plastic chairs. It has a comfy expression with its chunky feel and soft touch. The knit is made of 100% recycled polyester in yarn and filling. Designed with an alternating herringbone pattern effect playing with light and depth. The colour range is primarily monochromatic with some subdued colour blends. All colours matching or nicely combines with the HÅG Celi plastic and metal colours. These knitted covers are easily removable and replaceable.

Composition: 100% recycled polyester

Abrasion resistance: 60000 Martindale (EN ISO 12947-2)

Flammability: BS EN 1021: 1-2 (Cigarette & match), CA TB 117-2013

Light fastness: 8 (EN ISO 105-B02)

Rubbing fastness: 4-5/4-5 (Wet/Dry) (EN ISO 105X12)

Pilling: 5 (EN ISO 12945-2)

Environmental facts: EU Ecolabel, 100% free of heavy metals and harmful chemicals, ISO 14001 certified company

Design: Gabriel Design team, Gudrun Reikvam /Flokk Design team

Produced in: Lithuania

Cleaning: Professional dry cleaning (For further info follow Gabriel´s cleaning guidelines: Gabriel_Stain_guide_Shapeknit- www.gabriel.dk)









S=Standard Collection - normal delivery time from factory 10-15 working days.
E=Extended Collection - extended delivery time from factory 25-30 working days.
For larger orders, please contact Customer Service for delivery details.

HÅG Conventio® - conference chair

- HÅG inBalance® (balanced, flowing tilt function backwards and forwards)
- Black or silver coloured back stems, must be specified at time of order for models 9512 and 9522

The following applies for models 9510, 9511, 9520 and 9521:

- Legs in black or silver aluminium. Please specify colour at time of order
- Stackable (15 chairs), only available for 4 legged models
- Glides for hard or soft flooring need to be specified at time of order

Item no	Base model +	Price Group (PG)	Price Group							Price
			①	②	③	④	⑤	⑥	⑦	
9510	HÅG Conventio 9510 <ul style="list-style-type: none"> • Upholstered seat and backrest front (plastic back) • Removable upholstery • Built-in handle for carrying • Seat height: 455 mm 		2976	3036	3127	3249	3371	3885	4546	
9511	HÅG Conventio 9511 <ul style="list-style-type: none"> • Upholstered seat and backrest front (plastic back) • Removable upholstery • Built-in handle for carrying • 4 cm wider than 9510 • Seat height: 450 mm 		3285	3352	3451	3588	3721	4291	5022	
9512	HÅG Conventio 9512 <ul style="list-style-type: none"> • Upholstered seat and backrest front (plastic back) • Removable upholstery • 5 star plastic foot base (Ø635 mm): Black • 150 mm lift • Seat height: 400-540 mm • Backstems in Black or Silver 		3712	3788	3904	4055	4206	4850	5673	
9520	HÅG Conventio 9520 <ul style="list-style-type: none"> • Upholstered seat and back • Removable upholstery • Seat height: 455 mm 		3161	3223	3318	3448	3579	4128	4828	
9521	HÅG Conventio 9521 <ul style="list-style-type: none"> • Upholstered seat and back • Removable upholstery • 4 cm wider than 9520 • Seat height: 450 mm 		3511	3583	3690	3834	3976	4587	5367	
9522	HÅG Conventio 9522 <ul style="list-style-type: none"> • Upholstered seat and back • Removable upholstery • 5 star plastic foot base (Ø635 mm): Black • 150 mm lift • Seat height: 400-540 mm • Backstems in Black or Silver 		4060	4144	4270	4436	4602	5304	6206	

Accessories/Options/Surcharges:

AR421	Armrests in plastic	459
AR423	HÅG Writing tablet. Black, right-handed. Fold down tablet for storage and stacking of chair. (Only for: 9510, 9511, 9520, 9521)	713
AR424	HÅG Writing tablet. Black, right-handed + Armrest in plastic, left side. (Only for: 9510, 9511, 9520, 9521)	947
FB034	Five star base (Ø730 mm) in aluminium - silver/black (Only for: 9512, 9522)	220
FB035	Five star base (Ø730 mm) in polished aluminium (Only for: 9512, 9522)	1 261
CA016	Universal castors Ø65 mm, for hard and soft floors, black (Only for: 9512, 9522)	92
CA004	Glides (Only for: 9512, 9522)	0
TS001	Chair hanger. Must be specified at time of order. Can not be retrofitted (Only for: 9512, 9522)	518
TS003	Chair hanger. Must be specified at time of order. Can not be retrofitted (Only for: 9510, 9511, 9520, 9521)	518
AE400	Connection device - only available for 4 legged models without arms (Only for: 9510, 9511, 9520, 9521)	97
AE406	Connection device - only available for 4 legged models with arms (Only for: 9510, 9511, 9520, 9521)	97
108984	HÅG SlipCover available in Atlantic (Gabriel) off-white or grey (Only for: 9510, 9520)	862
149285	Chair trolley	2 909

NB: PRICES MAY VARY WHEN OPTIONS ARE PURCHASED SEPARATELY FROM COMPLETE CHAIRS



108984

HÅG Conventio Wing® - conference chair

- HÅG inBalance® (balanced, flowing tilt function backwards and forwards)
- Models 9811, 9821, 9831: 4 legs and backstems in matt black or silver coloured aluminium
- Please specify colour at time of order
- Models 9812, 9822, 9832: 5 star foot base in black plastic. 150 mm gas lift.
- Seat and backrest available in 5 different colours: Clay, Sea Green, Black, White and Red
- Stackable: 15 chairs (4 legged models)
- Glides for hard or soft flooring need to be specified at time of order

Item no	Base model +	Price Group (PG)	①	②	③	④	⑤	Price
9811	HÅG Conventio Wing 9811 • Plastic seat and back • Seat height: 430 mm							2 272
9812	HÅG Conventio Wing 9812 • Plastic seat and back • 5 star plastic foot base (Ø635 mm) • Seat height: 375-515 mm							2 932
9821	HÅG Conventio Wing 9821 • Removable upholstery on seat • Plastic back • Seat height: 430 mm		2 626	2 680	2 950	3 223	3 327	
9822	HÅG Conventio Wing 9822 • Removable upholstery on seat • Plastic back • 5 star plastic foot base (Ø635 mm) • Seat height: 380-520 mm		3 224	3 291	3 634	3 923	4 108	
9831	HÅG Conventio Wing 9831 • Removable upholstery on seat and back • Seat height: 430 mm		3 083	3 145	3 474	3 760	3 907	
9832	HÅG Conventio Wing 9832 • Removable upholstery on seat and back • 5 star plastic foot base (Ø635 mm) • Seat height: 380-520 mm		3 685	3 760	4 144	4 486	4 695	

Accessories/Options/Surcharges:

AR421	Armrests in plastic	459
AR423	HÅG Writing tablet. Black, right-handed. Fold down tablet for storage and stacking of chair. (Only for: 9811, 9821, 9831)	713
AR424	HÅG Writing tablet. Black, right-handed + Armrest in plastic, left side. (Only for: 9811, 9821, 9831)	947
165243-1A	Chair suspension for mounting under table top. Black	250
165243-2A	Chair suspension for mounting under table top. Silver	250
TS001	Chair hanger. Must be specified at time of order. Can not be retrofitted (Only for: 9812, 9822, 9832)	518
TS003	Chair hanger. Must be specified at time of order. Can not be retrofitted (Only for: 9811, 9821, 9831)	518
AE400	Connection device - only available for 4 legged models without arms (Only for: 9811, 9821, 9831)	97
AE406	Connection device - only available for 4 legged models with arms	97
FB034	Five star base (Ø730 mm) in aluminium - silver/black (Only for: 9812, 9822, 9832)	220
FB035	Five star base (Ø730 mm) in polished aluminium (Only for: 9812, 9822, 9832)	1 261
CA016	Universal castors Ø65 mm, for hard and soft floors, black (Only for: 9812, 9822, 9832)	92
CA004	Glides (Only for: 9812, 9822, 9832)	0
149285	Chair trolley	2 909

NB: PRICES MAY VARY WHEN OPTIONS ARE PURCHASED SEPARATELY FROM COMPLETE CHAIRS

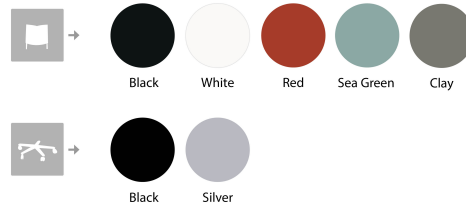



Matching colours for
HÅG Conventio Wing

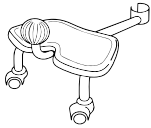

S=Standard
E=Extended

HÅG Accessories

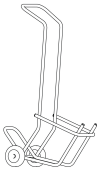
Item no	Base model +	Price Group (PG)	Price
165177-1A/2A	<p>HÅG StepUp 1 pcs</p> <ul style="list-style-type: none"> • For HÅG Capisco, HÅG Capisco Puls and HÅG Creed • Provides two extra levels for your feet • Greater variety of seating positions • Black (1A) or silver (2A) • Easy to attach and detach • For use with 150, 200 and 265 mm gas lifts • Suits desk heights of 80-95 cm • Add on: Universal castor, Ø65 mm, black (Must be specified at time of order) 		1434
165178-1A/2A	<p>HÅG StepUp</p> <ul style="list-style-type: none"> • For HÅG Capisco, HÅG Capisco Puls and HÅG Creed • As art. 165177, but two pack • Black (1A) or silver (2A) 		2864
165134	<p>HÅG Quickstep, 1 pcs</p> <ul style="list-style-type: none"> • Tilting footrest, stimulates circulation • Foot massager • Balance training 		1076
165129	<p>HÅG QuickStep</p> <ul style="list-style-type: none"> • Six pack 		5380
169121	<p>HÅG FootRing (Ø450 mm)</p> <ul style="list-style-type: none"> • Available colours (aluminium ring) / (plastic busher): Black/black (1A), White/black (3A), Blush Rose/black (5A), Moss Grey/black (7A), Silver/grey (2D), White/grey (3D) • Additional height for the feet to rest on • Compatible with all HÅG task chairs (except HÅG Executive) with 200 or 265 mm gas lifts 		1128
149285	<p>Chair trolley</p> <ul style="list-style-type: none"> • For HÅG Celi, HÅG Conventio and HÅG Conventio Wing (4 leg models only) • Recommended for max 8 pcs • Silver 		2909

Main Spare Parts

Explanation to colour codes:

No colour code specified = Semi matt polyester paint on metal components, or single black plastic parts

1 = Semi matt black polyester paint on metal components

2 = Fine structured silver polyester paint on metal components

3 = Semi matt white polyester paint on metal components

P = Polished metal

P1 = Polished metal and semi matt black polyester painted metal components

1A = Semi matt black polyester paint on metal components and black plastic parts

2A = Fine structured silver polyester paint on metal components and black plastic parts

2D = Fine structured silver polyester paint on metal components and grey plastic parts

3A = Semi matt white polyester paint on metal components and black plastic parts

3D = Semi matt white polyester paint on metal components and grey plastic parts

PA = Polished metal components and black plastic parts

BB = Glossy black polyester paint on metal components and black plastic parts

NB = Anodised metal components (aluminium colour) and black plastic parts

Item no	Gas lifts	Price
143200-1A	A, 150 mm, black	1002
143200-2A	A, 150 mm, silver	1002
143200-3	A, 150 mm, white for HÅG Tion, HÅG Capisco and HÅG Capisco Puls	1002
143202-1A	D, 200 mm, black	1097
143202-2A	D, 200 mm, silver	1097
143202-3	D, 200 mm, white for HÅG Tion, HÅG Capisco and HÅG Capisco Puls	1097
143204-1A	E, 265 mm, black	1172
143204-2A	E, 265 mm, silver	1172
143204-3	E, 265 mm white, for HÅG Capisco and HÅG Capisco Puls	1172
143173-1A	200 mm, with black lift cover for HÅG Executive models	1217
143173-PA	200 mm, with polished lift cover for HÅG Executive models	1217
143172-1A	150 mm, with black lift cover for HÅG Executive models	654
143172-PA	150 mm, with polished lift cover for HÅG Executive models	654
143212-1A	150 mm, with black lift cover for HÅG Executive meeting models	654
143212-PA	150 mm, with polished lift cover for HÅG Executive meeting models	654
143206-1A	150 mm, black, for HÅG H03, HÅG Conventio, HÅG Conventio Wing	755
143200-5	A, 150 mm, Blush Rose for HÅG Tion	1002
143200-7	A, 150 mm, Moss Grey for HÅG Tion	1002
143202-5	D, 200 mm, Blush Rose for HÅG Tion	1097
143202-7	D, 200 mm, Moss Grey for HÅG Tion	1097

Item no	Gas lifts HÅG SoFi/HÅG Futu	Price
143227-1A	150 mm, black, for HÅG SoFi/HÅG Futu. For models produced after 31.10.2023	1030
143227-2A	150 mm, silver, for HÅG SoFi/HÅG Futu. For models produced after 31.10.2023	1030
143227-3A	150 mm, white, for HÅG SoFi. For models produced after 31.10.2023	1030
143228-1A	200 mm, black, for HÅG SoFi/HÅG Futu. For models produced after 31.10.2023	1143
143228-2A	200 mm, silver, for HÅG SoFi/HÅG Futu. For models produced after 31.10.2023	1143
143228-3A	200 mm, white, for HÅG SoFi. For models produced after 31.10.2023	1143

Item no	Gas lifts HÅG SoFi/HÅG Futu	Price
143211-1A	165 mm gaslift, black for HÅG SoFi/HÅG Futu. For models produced until 30.10.2023	1030
143211-2A	165 mm, silver, for HÅG SoFi/HÅG Futu. For models produced until 30.10.2023	1030
143211-3A	165 mm, white, for HÅG SoFi. For models produced until 30.10.2023	1030
143218-1A	200 mm, black for HÅG SoFi/HÅG Futu. For models produced until 30.10.2023	1143
143218-2A	200 mm, silver, for HÅG SoFi/HÅG Futu. For models produced until 30.10.2023	1143
143218-3A	200 mm, white for HÅG SoFi. For models produced until 30.10.2023	1143
Item no	Universal castors for soft floor/carpets and for hard floors (price per castor)	Price
125177	Castors Ø65 mm, for hard and soft floors, black	91
125177-D	Castors Ø65 mm, for hard and soft floors, grey	91
125189	Castors Ø65mm HÅG Tion, for hard and soft floors, black	91
Item no	Castors for hard floors (price per castor)	Price
125108	Castors Ø50 mm, for hard floors, black	91
Item no	Castors for soft floor / carpets (price per castor)	Price
125104	Castors for soft floors, Ø50 mm, black	91
125178	Castors for soft floors, Ø65 mm, black	91
Item no	Glides (price per glide)	Price
125182	Universal glides for foot bases (task chairs)	91
113846	Carpet glides HÅG Conventio and HÅG Conventio Wing	17
113927	Carpet glides HÅG executive meeting, HÅG SoFi Comm. and HÅG Futu Comm. with 4-star base	16
Item no	Felt glides for conference/visitor chairs (price per glide)	Price
125186	Felt glides HÅG Conventio and HÅG Conventio Wing	32
125172	Felt glides HÅG Creed 6071	16
125179	Felt glides (22 mm) for HÅG Executive meeting, HÅG SoFi Comm., HÅG Futu Comm. with 4-star base	16
Item no	Footbases, excluding castors	Price
126158	Five star foot base for HÅG Executive models in matt black aluminium	1451
126154-P	Five star foot base for HÅG Executive models in polished aluminium	2327
126161	Five star foot base for HÅG Executive meeting in matt black aluminium	1386
126160-P	Five star foot base for HÅG Executive meeting in polished aluminium	2240
113162	Five star foot base for HÅG Conventio 9512, 9522, HÅG Conventio Wing 9812, 9822, 9832 in black plastic	518
113163	Five star foot base for HÅG H03 in black plastic	518
113940	Five star foot base for HÅG Futu in black plastic	518
113016	Five star foot base for HÅG Capisco Puls, in black plastic	661
126172-2	Five star foot base for HÅG Creed/Capisco/Capisco Puls in silver aluminium	966
126172-1	Five star foot base for HÅG Creed/Capisco/Capisco Puls in black aluminium	966
126172-3	Five star foot base for HÅG Capisco/Capisco Puls in white aluminium	966

Item no	Footbases, excluding castors	Price
126172-P	Five star foot base for HÅG Creed/Capisco/Capisco Puls in polished aluminium	1826
126164-2A	Four star foot base for HÅG SoFi Comm., in silver aluminium, w/hard glides for soft floor	1017
126164-1A	Four star foot base for HÅG Executive meeting/SoFi Comm., in black alum. w/hard glides for soft floor	1017
126164-3A	Four star foot base for HÅG SoFi Comm., in white aluminium, w/hard glides for soft floor	1017
126164-PA	Four star foot base for HÅG Executive meeting/SoFi Comm., in polished alum. w/hard glides for soft floor	1762
126165-2A	Four star foot base for HÅG SoFi Comm., in silver aluminium, w/soft glides for hard floor	1017
126165-1A	Four star foot base for HÅG Executive meeting/SoFi Comm., black alum. w/soft glides for hard floors	1017
126165-3A	Four star foot base for HÅG SoFi Comm., in white aluminium, w/soft glides for hard floor	1017
126165-PA	Four star foot base for HÅG Executive meeting/SoFi Comm., in polished alum w/soft glides for hard floor	1762
126176-2	Five star foot base for HÅG SoFi/Futu/SoFi Comm. in silver aluminium	888
126176-1	Five star foot base for HÅG SoFi/Futu/SoFi Comm. in black aluminium	888
126176-3	Five star foot base for HÅG SoFi/SoFi Comm. in white aluminium	888
126173-P	Five star foot base for HÅG SoFi/Futu/SoFi Comm. in polished aluminium	1631
126185-1	Five star foot base for HÅG Tion in Black painted aluminium	655
126185-2	Five star foot base for HÅG Tion in Silver painted aluminium	659
126185-3	Five star foot base for HÅG Tion in White painted aluminium	656
126185-7	Five star foot base for HÅG Tion in Moss Grey painted aluminium	669
126185-5	Five star foot base for HÅG Tion in Blush Rose painted aluminium	669
126184-P	Five star foot base for HÅG Tion in Polished aluminium	1119
126184-9	Five star foot base for HÅG Tion in Tumbled aluminium	845

Item no	Armrests HÅG SoFi	Price
133579-2D	Armrests HÅG SoFi, adj. in light grey plastic with soft tops and stem in silver painted aluminium	1881
133579-1A	Armrests HÅG SoFi, adj. in black plastic with soft tops and stem in black painted aluminium	1881
133579-3D	Armrests HÅG SoFi, adj. in light grey plastic with soft tops and stem in white painted aluminium	1881
133579-PA	Armrests HÅG SoFi, adj. in black plastic with soft tops and stem in polished painted aluminium	3324
133579-2	Armrests HÅG SoFi, adj. in silver painted alum. with soft tops	2242
133579-1	Armrests HÅG SoFi, adj. in black painted alum. with soft tops	2242
133579-3	Armrests HÅG SoFi, adj. in white painted alum. with soft tops	2242
133579-P	Armrests HÅG SoFi, adj. in polished alum. with soft tops	3685
	- Surcharge for HÅG SlideBack	398
	- Surcharge for 3D	429
	- Surcharge for leather top	738

Item no	Armrests HÅG Tion	Price
133575-1	Armrests HÅG Tion Black	754
133575-2	Armrests HÅG Tion Silver	754
133575-3	Armrests HÅG Tion White	754
133575-7	Armrests HÅG Tion Moss Grey	754
133575-5	Armrests HÅG Tion Blush Rose	754

Item no	Armrests HÅG Tion	Price
133575-P	Armrests HÅG Tion Polished	1 286
133575-9	Armrests HÅG Tion Tumbled	1 075

Item no	Armrests HÅG Creed	Price
133299-1A	Armrests HÅG Creed, adjustable, black	1 343
133299-2A	Armrests HÅG Creed, adjustable, silver	1 343
133300-1A	Armrests HÅG Creed, adj., w HÅG SwingBack, black	2 340
133300-2A	Armrests HÅG Creed, adj., w HÅG SwingBack, silver	2 340
133333-1A	Armrests HÅG Creed Comm. 6071 & 6172 black	1 086
133333-2A	Armrests HÅG Creed Comm. 6071 & 6172 silver	1 086
AR217	- Surcharge for armrests with 3D-top	878

Item no	Armrests	Price
133448-BB	Armrests HÅG Executive, task and meeting, basic, black	1 971
133548-1A	Armrests HÅG Executive task, HÅG TiltDown, black	3 192
133548-PA	Armrests HÅG Executive task, HÅG TiltDown, polished	3 192
133453-2A	Armrests HÅG Futu, adjustable silver	1 124
133453-1A	Armrests HÅG Futu, adjustable black	1 124
133322	Armrests HÅG H03, adjustable black	779
165232	Armrests HÅG Conventio, HÅG Conventio Wing, black	462

Item no	Headrest complete	①	②	③	④	⑤	⑥	⑦
134188	Headrest HÅG SoFi 7200, 7300	2 091	2 137	2 212	2 298	2 386	2 741	3 208
134189	Headrest HÅG SoFi mesh 7500	2 091	2 137	2 212	2 298	2 386	2 741	3 208
134172	Headrest HÅG Capisco 8106, 8107, 8126, 8127	2 746	2 916	3 127	3 366	3 678	4 457	5 215
134191	Headrest HÅG Tribute 9031	3 074	3 141	3 250	3 380	3 506	4 032	4 717
134194	Headrest HÅG Creed	2 667	2 833	3 033	3 267	3 572	4 329	5 064

Item no	Coathanger	Price
165256	Coat hanger, light grey or black plastic, for HÅG SoFi 7500 Mesh only. Not applicable with headrest.	636
102340-B01	Coat hanger, black stained wood, for HÅG Excellence and HÅG Inspiration	Price on request
168403-1A	Coat hanger, black w/bushing, for HÅG Tribute 9031 with headrest	602
168403-PA	Coat hanger, polished w/bushing, for HÅG Tribute 9031 with headrest	732

Item no	Chair hanger	Price
750720	Chair hanger HÅG Celi	170
115819	Chair hanger HÅG Tion	170

Item no	Lumbar support	Price
213184	Lumbar support HÅG Futu mesh	371

Item no	Replaceable upholstery HÅG Executive	①	②	③	④	⑤	⑥	⑦
108781	Headrest HÅG Excellence and HÅG Inspiration 9231,9331		851	882	909	942	1 095	1 282
111546	Back, complete, HÅG Tribute 9021, 9073	9 212	9 400	9 682	10 057	10 341	11 467	13 417
111547	Back, complete, HÅG Tribute 9031	10 184	10 394	10 706	11 121	11 435	12 680	14 836
108852	Back, padded, HÅG Excellence 9321						9 933	11 621
108853	Back, padded, HÅG Excellence 9331						10 156	11 884
108005	Seat cover HÅG Tribute	1 052	1 127	1 286	1 551	1 774	1 946	2 277
108009	Seat, HÅG Excellence/Inspiration		1 181	1 224	1 261	1 308	1 856	2 171
146256	Seat, complete, HÅG Tribute	1 774	1 917	2 213	2 603	3 028	3 342	3 909
146257	Seat, complete, HÅG Excellence/Inspiration		2 035	2 109	2 172	2 252	3 182	3 723
108779	Lumbar support HÅG Excellence and HÅG Inspiration		1 328	1 377	1 418	1 470	1 712	2 004
Item no	Replaceable upholstery HÅG SoFi	①	②	③	④	⑤	⑥	⑦
111533	Headrest upholstery HÅG SoFi complete	926	956	1 063	1 127	1 376	1 470	1 720
108975	Back HÅG SoFi 7200 (medium)	993	1 026	1 141	1 209	1 475	1 578	1 846
108974	Back HÅG SoFi 7300 (high)	1 086	1 123	1 245	1 319	1 607	1 723	2 015
108976	Seat HÅG SoFi	1 184	1 225	1 359	1 442	1 759	1 880	2 200
108001	Lumbar pillow front, HÅG SoFi 750x (mesh)	82	83	85	91	92	107	125
108002	Lumbar pillow rear, HÅG SoFi 750x (mesh)	82	83	85	91	92	107	125
Item no	Replaceable upholstery HÅG Tion	①	②	③	④	⑤	⑥	⑦
108035	Seat cover HÅG Tion	1 026	1 037	1 077	1 131	1 199	1 391	1 628
108036	Back cover HÅG Tion	857	865	901	945	1 002	1 161	1 359
Item no	Replaceable upholstery HÅG Capisco	①	②	③	④	⑤	⑥	⑦
108706	Headrest HÅG Capisco and HÅG Creed	641	655	689	703	735	806	943
108803	Back, HÅG Capisco all models	1 347	1 373	1 729	2 375	2 513	3 082	3 607
108769	Seat, HÅG Capisco 8105, 8106, 8107	1 247	1 270	1 508	1 911	2 148	2 984	3 492
108800	Seat, HÅG Capisco 8126, 8127	1 269	1 296	1 492	1 639	2 045	2 254	2 637
Item no	Replaceable upholstery HÅG Capisco Puls	①	②	③	④	⑤	⑥	⑦
108037	Cushion, HÅG Capisco Puls, mod. 8002 and 8020 (visible seaming)	1 234	1 261	1 304	1 347	1 397	1 606	1 879
108958	Pad, HÅG Capisco Puls, model 8001 and 8010	412	419	441	458	474	514	602
Item no	Replaceable upholstery HÅG Creed	①	②	③	④	⑤	⑥	⑦
108706	Headrest HÅG Capisco and HÅG Creed	641	655	689	703	735	806	943
108030	Back HÅG Creed 6002	1 143	1 336	1 401	1 465	1 508	1 680	1 966
108528	Back, HÅG Creed 6003 (and old HÅG H05 5300)	1 336	1 372	1 535	1 645	1 985	2 140	2 502
108031	Back HÅG Creed 6004	1 188	1 465	1 508	1 563	1 627	1 773	2 074
108529	Back, HÅG Creed 6005 (and old HÅG H05 5500)	1 349	1 390	1 548	1 667	2 009	2 162	2 529
108032	Back HÅG Creed 6006	1 188	1 465	1 508	1 563	1 627	1 773	2 074

Item no	Replaceable upholstery HÅG Creed	①	②	③	④	⑤	⑥	⑦
108029	Seat HÅG Creed (except 6056, 6071, 6172, SHORT)	913	929	959	989	1026	1143	1336
108696	Back, HÅG Creed Comm. 6071, 6172	1289	1319	1401	1449	1496	1667	1951
108697	Seat, HÅG Creed Comm. 6071	929	943	986	1026	1073	1159	1357

Item no	Replaceable uph. for the discontinued HÅG H05	①	②	③	④	⑤	⑥
108603	Headrest, HÅG H05 5200, 5400, 5600	1114	1147	1278	1373	1660	1783
108515	Back, HÅG H05 5200	1143	1336	1401	1465	1508	1680
108516	Back, HÅG H05 5400	1188	1465	1508	1563	1627	1773
108517	Back, HÅG H05 5600	1188	1465	1508	1563	1627	1773
108630	Back, HÅG H05 5370	1188	1465	1508	1563	1627	1773
108632	Back, HÅG H05 5470	1188	1465	1508	1563	1627	1773
108522	Seat, HÅG H05	913	929	959	989	1026	1143
108631	Seat, HÅG H05 5370, 5470	913	929	959	989	1026	1143

Item no	Replaceable uph. for the discontinued HÅG H04	①	②	③	④	⑤	⑥
108692	Back, HÅG H04 4100, 4200	1143	1336	1401	1465	1508	1680
108690	Back, HÅG H04 4400	1188	1465	1508	1563	1627	1773
108691	Back, HÅG H04 4600	1188	1465	1508	1563	1627	1773
108695	Back, HÅG H04 4650	1188	1465	1508	1563	1627	1773
108869	Seat, HÅG H04 4100	913	929	959	989	1026	1143
108870	Seat, HÅG H04 4200, 4400, 4600	913	929	959	989	1026	1143
108871	Seat, HÅG H04 4650	913	929	959	989	1026	1143

Item no	Replaceable upholstery HÅG H03	①	②	③	④	⑤	⑥	⑦
108620	Back, HÅG H03 330	1069	1091	1124	1167	1211	1396	1634
108615	Back, HÅG H03 340	952	971	1001	1042	1077	1244	1455
108673	Seat, HÅG H03 330, 340	1069	1091	1124	1167	1211	1396	1634
108619	Seat, HÅG H03 350	1184	1210	1245	1293	1342	1547	1809

Item no	Replaceable upholstery HÅG Celi	①	②	③	④	⑤	⑥	⑦	Price
146273	Seat (incl. foam), HÅG Celi 9140, 9160	602	677	732	782	865	984	1482	
146275	Seat (incl. foam), HÅG Celi 9240	602	677	732	782	865	984	1482	
108040	Back, HÅG Celi 9160	616	635	690	841	963	1384	1630	
146271	Back & Seat (incl. foam), HÅG Celi 9160	1218	1311	1421	1624	1826	2367	3111	
108042	Seat in CeliKnit, HÅG Celi 9140, 9160								903
108043	Back in CeliKnit, HÅG Celi 9160								690
146272	Back & Seat in CeliKnit, HÅG Celi 9160								1592

Item no	Replaceable upholstery HÅG Conventio	①	②	③	④	⑤	⑥	⑦
108728	Back, HÅG Conventio 9510	952	971	1001	1042	1077	1244	1455
108730	Back, HÅG Conventio 9511, 9512	952	971	1001	1042	1077	1244	1455

Item no	Replaceable upholstery HÅG Conventio	①	②	③	④	⑤	⑥	⑦
108391	Back, HÅG Conventio 9520	984	1 003	1 033	1 073	1 113	1 285	1 503
108534	Back, HÅG Conventio 9521, 9522	984	1 003	1 033	1 073	1 113	1 285	1 503
108729	Seat, HÅG Conventio 9510	952	971	1 001	1 042	1 077	1 244	1 455
108731	Seat, HÅG Conventio 9511, 9512	952	971	1 001	1 042	1 077	1 244	1 455
108946	Seat, HÅG Conventio 9520	984	1 003	1 033	1 073	1 113	1 285	1 503
108535	Seat, HÅG Conventio 9521, 9522	984	1 003	1 033	1 073	1 113	1 285	1 503

Item no	Replaceable upholstery HÅG Conventio Wing	①	②	③	④	⑤
108872	Back, HÅG Conventio Wing 9831, 9832	760	775	799	829	862
108873	Seat, HÅG Conventio Wing 9821, 9822, 9831, 9832	720	735	755	786	815

Item no	Miscellaneous	Price
149146	Disassembly tool for gas lift	638
149203	Disassembly tool for various (for example for removing HÅG Creed back and HÅG Creed/Capisco seat)	179

Removable upholsteries are available for all HÅG chairs. Please contact Customer Service for support.

Physical Measurements - HÅG task and meeting chairs

HÅG office (task) chairs are tested in accordance with EN 1335-1.

EN 1335 is an European Standard for office chairs and considers dimensions of the chair, safety requirements and safety test methods. The European Standard tests are based on 8 hours daily use by persons weighing up to 110 kg (17.3 stone).

HÅG meeting chairs are tested in accordance with EN 16139 and has fewer measurements given compared to EN 1335.

EN 16139 is an European Standard that specifies requirements for the safety, strength and durability of all types of non-domestic seating.

TABLE OVERVIEW:

HÅG SoFi and HÅG Capisco

HÅG Capisco Puls, HÅG Futu and HÅG H03

HÅG Tion and HÅG Creed

HÅG executive collection

- HÅG Tribute
- HÅG Inspiration
- HÅG Excellence

MEASURE POINT REFERENCES:

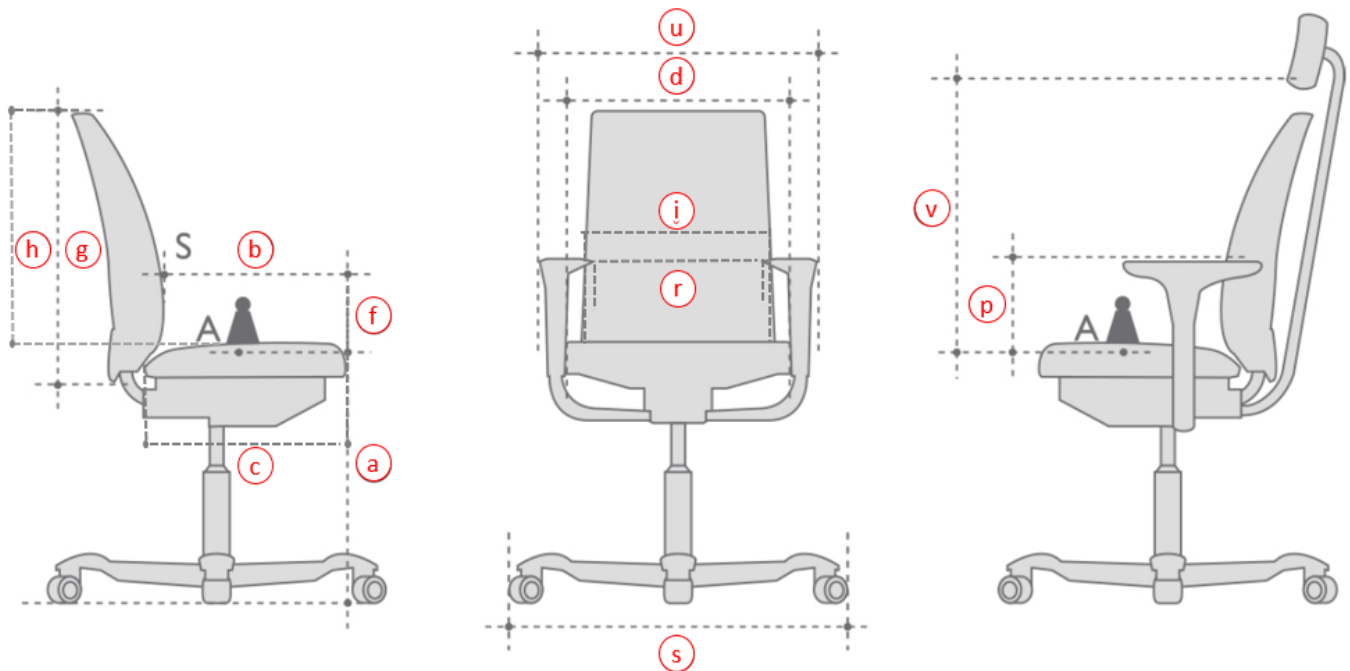

		HÅG SoFi						HÅG Capisco				
Models:		task			meeting			HÅG Capisco 8105	HÅG Capisco 8106	HÅG Capisco 8107	HÅG Capisco 8126	HÅG Capisco 8127
		HÅG SoFi 7200	HÅG SoFi 7300	HÅG SoFi mesh 7500	HÅG SoFi comm 7202	HÅG SoFi comm 7302	HÅG SoFi mesh comm 7502					
All measurements in mm. Few exceptions are specified.												
Seat height, measured with 64 kg load	150 mm lift* (a)	393-541	393-541	397-546	393-541	393-541	397-546	380-515	417-547	417-547	417-547	417-547
	200 mm lift (a)	450-640	450-640	450-640				445-630	470-655	470-655	470-655	470-655
	265 mm lift (a)							530-790	555-810	555-810	555-810	555-810
Seat depth with slide (b)		386-460	386-460	393-465	386-460	386-460	393-465		335-390	335-390	335-390	335-390
Seat depth (c)		443	443	446	443	443	446					
Seat width (d)		451	451	448	451	451	448	470	470	470	470	470
Height of the back supporting point (S) above the seat (f)		167-228	167-228	167-234	167-228	167-228	167-234		105-195	105-195	105-195	105-195
Backrest height (g)		608	708	725	708	708	725		460	460	460	460
Backrest height adjustment (h)									390-480	390-480	390-480	390-480
Backrest width (i)		442	442	467	442	442	467					
Back rest inclination (deg)		31.5	31.5	30	24	24	24		16.8	16.8	16.8	16.8
Armrest height (p)		195-307	195-307	188-299	195-307	195-307	188-299					
Headrest height (v)		630-835	630-835	630-835						555-785		555-785
Distance between armrests (r)		385-520	385-520	416-554	385-520	385-520	416-554					
Chair width (u)		600-715	600-715	600-715	600-715	600-715	600-715		595	595	595	595
Neutral position (deg)		- 4	- 4	- 4	- 2	- 2	- 2		- 2	- 2	- 2	- 2
Tilt range (deg)**		(12.9) - (-17.4)	(12.9) - (-17.4)	(13) - (-17)	(11) - (-13)	(11) - (-13)	(11) - (-13)		(2) - (-15)	(2) - (-15)	(2) - (-15)	(2) - (-15)
Foot base diameter (s)		730	730	730	785	785	785	730	730	730	730	730
Chair weight (kg)		17.3	17.5	17	16.2	16.7	15.7	7.5	14	15.5	14.5	15.5

* According to EN1335 Class A ** Tilt range degrees (forwards) - (backwards)
Please note that these measurements are not absolute. They may vary slightly from chair to chair.

		HÅG Capisco Puls				HÅG Futu			HÅG H03		
Models:						task		meeting			
All measurements in mm. Few exceptions are specified.		HÅG Capisco Puls 8001	HÅG Capisco Puls 8002	HÅG Capisco Puls 8010	HÅG Capisco Puls 8020	HÅG Futu mesh 1100-S	HÅG Futu 1200-S	HÅG Futu mesh comm 1102-S	HÅG H03 330	HÅG H03 340	HÅG H03 350
Seat height, measured with 64 kg load	150 mm lift* (a)	365-500	375-515	392-525	392-525	398-551	398-551	398-551	412-551	412-551	412-551
	200 mm lift (a)	455-620	470-635	455-640	470-650	450-640	450-640		520-700	520-700	520-700
	265 mm lift (a)	540-770	555-785	540-795	555-805				548-783	548-783	548-783
Seat depth with slide (b)				399-439	399-439	390-470	385-460	390-470	400-425	400-425	400-425
Seat depth (c)		415	415	415	415	460	460	460	460	460	460
Seat width (d)		460	460	460	460	460	460	460	420	420	445
Height of the back supporting point (S) above the seat (f)				140-230	127-222	170-240	160-255		174-244	165-235	159-229
Backrest height (g)				399	399	600	600	600	300	410	425
Backrest height adjustment (h)				381-471	381-471				336-406	336-406	458-528
Backrest width (i)				470	470	370	554	370	400	400	410
Back rest inclination (deg)				17.8	17.8	27	27	27	21.4	21.4	21.4
Armrest height (p)						164-264	164-264	164-264	171-281	171-281	171-281
Headrest height (v)											
Distance between armrests (r)						444-554	444-554	444-554	458	458	458
Chair width (u)				565	565	610-715	610-715	610-715	630	630	630
Neutral position (deg)		- 3.8	- 3.8	- 3.8	- 3.8	- 4	- 4	- 4	0	0	0
Tilt range (deg)**				(3.8) - (-19.2)	(3.8) - (-19.2)	(10.6) - (-17.6)	(10.6) - (-17.6)	(10.6) - (-17.6)	(12) - (-10)	(12) - (-10)	(12) - (-10)
Foot base diameter (s)		730	730	730	730	730	730	785	686	686	686
Chair weight (kg)		7	7	11.1	11.1	16.2	15.3	16.2	12	12	13

* According to EN1335 Class A ** Tilt range degrees (forwards) - (backwards)

Please note that these measurements are not absolute. They may vary slightly from chair to chair.

		HÅG Tion					HÅG Creed							
Models:							task						meeting	
All measurements in mm. Few exceptions are specified.		HÅG Tion 2100	HÅG Tion 2140	HÅG Tion 2160	HÅG Tion 2200	HÅG Tion 2240	HÅG Creed 6002	HÅG Creed 6003	HÅG Creed 6004	HÅG Creed 6005	HÅG Creed 6006	HÅG Creed 6056	HÅG Creed comm 6071	HÅG Creed comm 6172
Seat height, measured with 64 kg load	150 mm lift* (a)	408-542	408-542	408-542	408-542	408-542	395-535	395-535	395-535	395-535	395-535	405-545		405-545
	200 mm lift (a)	485-664	485-664	485-664	485-664	485-664	455-635	455-635	455-635	455-635	455-635	464-647		
Seat depth with slide (b)		425	435	435	422	435	390-490	400-420	390-490	400-420	390-490	390-490		
Seat depth (c)		425	435	435	422	435	425	425	430	425	425	445	430	430
Seat width (d)		455	470	470	450	470	455	455	445	455	450	450	445	445
Height of the back supporting point (S) above the seat (f)		240	240	240	240	240	170-226	170-226	170-228	170-226	170-239	170-239		
Backrest height (g)		251	251	257	253	253	455	475	510	555	585	590	510	510
Backrest height adjustment (h)							401-454	401-454	466-511	401-454	508-552	512-557		
Backrest width (i)		464	464	464	464	464	390	388	385	388	385	385	385	385
Back rest inclination (deg)		-5.7	-5.7	-5.7	-5.7	-5.7	20.3	20.3	19.1	20.3	20.4	20.4	22	22
Armrest height (p)		229	229	229	229	229	390-490	390-490	182-277	390-490	200-300	200-300		
Distance between armrests (r)		492	492	492	492	492	454-546		454-546		454-546	454-546		
Chair width (u)		600	600	600	600	600								
Neutral position (deg)		-3	-3	-3	-3	-3	-1	-1	-1	-1	-1	-1	-5	-5
Tilt range (deg)		(7.4) - (-14)	(7.4) - (-14)	(7.4) - (-14)	(7.4) - (-14)	(7.4) - (-14)	(15) - (-16)	(15) - (-16)	(15) - (-16)	(15) - (-16)	(15) - (-16)	(15) - (-16)	(9) - (-13)	(9) - (-13)
Foot base diameter (s)		620	620	620	620	620	730	730	730	730	730	730		730
Chair weight (kg)		10.9	10.9	11.1	13.7	13.2	13.3	15.7	17	18.6	19	19.5	10	9

* According to EN1335 Class A ** Tilt range degrees (forwards) - (backwards)

Please note that these measurements are not absolute. They may vary slightly from chair to chair.

		HÅG executive								
Model:		task					meeting			
		HÅG Tribute 9021	HÅG Tribute 9031 (headrest)	HÅG Inspiration 9221	HÅG Inspiration 9231	HÅG Excellence 9321	HÅG Excellence 9331	HÅG Tribute meeting 9073	HÅG Inspiration meeting 9273	HÅG Excellence meeting 9373
All measurements in mm. Few exceptions are specified.										
Seat height, measured with 64 kg load	150 mm lift* (a)	387-525	387-525	387-525	387-525	387-525	387-525	387-525	387-525	387-525
	200 mm lift (a)	460-640	460-640	460-640	460-640	460-640	460-640			
Seat depth with slide (b)		390-508	390-508	390-508	390-508	390-508	390-508			
Seat depth (c)		480	480	480	480	480	480	480	480	480
Seat width (d)		460	460	460	460	460	460	460	460	460
Height of the back supporting point (S) above the seat (f)		170-238	170-238	128-233	128-233	128-233	128-233	170-238	128-233	128-233
Backrest height (g)		740	740	923	1 203	923	1 203	740	923	923
Backrest height adjustment (h)										
Backrest width (i)		460	460	460	460	460	460	460	460	460
Back rest inclination (deg)		28.3	28.3	28.3	28.3	28.3	28.3	26	27	27
Armrest height (p)		200-300	200-300	200-300	200-300	200-300	200-300			
Headrest height (v)			680-795		660-770		660-770	680-795		
Distance between armrests (r)		458-536	458-536	458-536	458-536	458-536	458-536	458-536	458-536	458-536
Chair width (u)		495-675	495-675	495-675	495-675	495-675	495-675	495-675	495-675	495-675
Neutral position (deg)		- 3	- 3	- 3	- 3	- 3	- 3	- 4	- 4	- 4
Tilt range (deg)**		(7) - (-18)	(7) - (-18)	(7) - (-18)	(7) - (-18)	(7) - (-18)	(7) - (-18)	(3) - (-13)	(4) - (-13)	(4) - (-13)
Foot base diameter (s)		740	740	740	740	740	740	650	650	650
Chair weight (kg)		25	25	20	21.5	19.5	22	19.5	16	16.5

* According to EN1335 Class A ** Tilt range degrees (forwards) - (backwards)
Please note that these measurements are not absolute. They may vary slightly from chair to chair.

Physical Measurements - HÅG conference chairs

HÅG conference chairs are tested in accordance with EN 16139.

EN 16139 is an European Standard that specifies requirements for the safety, strength and durability of all types of non-domestic seating.

All measurements in mm. Where a chair is adjustable, minimum and maximum measurements are listed.

	HÅG Celi		HÅG Conventio Wing						HÅG Conventio		
Model:	9100/9140/ 9160	9200/9240	9811	9821	9831	9812	9822	9832	9510/ 9520	9511/ 9521	9512/ 9522
Seat height (mm)	440	440	460	460	430				450	455	
Seat height (150 mm lift) (mm)						365-511	365-511	365-511			375-509
Chair height (mm)	810	810	900	900	900	850-1002	850-1002	850-1002	875	884	840
Seat depth (mm)	415	415	415	415	415	410	410	410	435	455	450
Chair depth (mm)	515	515	590	590	590	595	595	595	605	627	625
Seat width (mm)	430	430	425	430	430	430	430	430	385	425	425
Chair width (mm)	430	430	510	510	510	465*	465*	465*	475	516	560
Back rest inclination (deg)	14	14	14	14	14	14	14	14	14	14	14
Armrest height (mm)	230	230	245	245	245	245	245	245	230	230	230
Distance between armrests (mm)	526	526	475	475	475	475	475	475	473	513	475
Neutral position (deg)	- 3.5	- 3.5	- 1	- 1	- 1	- 1	- 1	- 1	- 5	- 5	- 5
Tilt range (deg)	(12) - (-12)	(12) - (-12)	(12) - (-11)	(12) - (-11)	(12) - (-11)	(12) - (-11)	(12) - (-11)	(12) - (-11)	(12) - (-11)	(12) - (-11)	(12) - (-11)
Foot base diameter (mm)						635	635	635			635
Chair weight (kg)	4.8	4.8	5.6*	5.6*	5.6*	7.7*	7.7*	7.7*	4.7	5.3	9.0

* Measurements without armrests

Please note that the measurements are not absolute. They may vary slightly from chair to chair.

Product Tests

Models:	ANSI/BIFMA (US)	EN 1335	EN 16139	GS (DE)	BS 5459 (GB)	EN 1729	ISO 1716 (Calorific value)
HÅG SoFi upholst.	Yes	Yes Type A		Yes	Yes		Yes
HÅG SoFi mesh	Yes	Yes Type A		Yes	Yes		Yes
HÅG SoFi comm.	Yes		Yes	Yes			
HÅG Capisco	Yes	Yes Type A	Yes**	Yes			
HÅG Capisco Puls	Yes	Yes Type A	Yes**	Yes			
HÅG Tion		Yes Type B	Yes	Yes		Yes	
HÅG Futu solid	Yes	Yes Type A		Yes	Yes		
HÅG Futu mesh	Yes	Yes Type A		Yes			
HÅG executive	Yes***	Yes*** Type A (Except HÅG Tribute) Type B (HÅG Tribute)		Yes*** (Except HÅG Tribute)	Yes*** (Except HÅG Tribute)		
HÅG executive meeting	Yes***		Yes	Yes***			
HÅG Creed		Yes Type A		Yes			
HÅG Creed comm.			Yes	Yes			
HÅG H03	Yes	Yes Type B		Yes			
HÅG Celi	Yes		Yes	Yes		Yes	
HÅG Conventio	Yes		Yes (Yes ¹)	Yes pending			
HÅG Conventio Wing	Yes		(Yes ¹)	Yes		Yes	
HÅG tablet arm	Yes		Yes				

¹ Without armrests

() Model with star base

* With 3D armrests

**Model 8001, 8002 and 8105

*** Old HÅG H09 models, renamed HÅG executive

Environmental Certificates

Environmental information	EPD (Environmental Product Declaration)	Key environmental indicators (from EPD, the figures are representing the product excluded packaging)			The Nordic Swan Ecolabel	GREENGUARD Gold	Möbelfakta (SE)
		Carbon footprint (kg CO ₂ -eq)	Total energy use (MJ)	Amount of recycled materials			
HÅG SoFi 7300	Yes	62.85 *	987.87 *	47.58 % *		Yes	Yes
HÅG SoFi mesh 7500	Yes	57.47 *	904.17 *	46.28 % *		Yes	Yes
HÅG Capisco 8106	Yes	32.87	440.64	49.52 %		Yes	Yes
HÅG Capisco Puls 8010	Yes	25.39 *	407.13 *	57.79 % *		Yes	Yes
HÅG Tion 2100	Yes	35.74	539.73	73.11 %	Yes**	Yes (PP shell models)	Yes
HÅG Futu mesh 1100	Yes	57.38	886.83	39.81 %		Yes	Yes
HÅG Futu 1200	Yes	52.94	817.67	42.22 %		Yes	Yes
HÅG Inspiration 9231 1)	Yes	95.04	1328.55	44.25 %		Yes	Yes
HÅG Excellence 9331 1)	Yes	104.60	1383.50	43.29 %		Yes	Yes
HÅG Tribute 9031 1)	Yes	84.41	1258.26	45.90 %		Yes	Yes
HÅG Creed 6004	Yes	44.27	531.58	40.37 %		Yes	Yes
HÅG Creed 6071	No					Yes	
HÅG H03 330	No					Yes	
HÅG Celi	Yes	11.46 (model 9100) 10.52 (model 9200)	199.52 (model 9100) 250.08 (model 9200)	82.29* % (model 9100) 50.16 % (model 9200)		Yes	Yes
HÅG Conventio 9510	No					Yes	
HÅG Conventio Wing	No					Yes	Yes (models 9811, 9821, 9831)

An EPD (Environmental Product Declaration) is a document that summarises a product's environmental performance. An EPD is based on a life cycle assessment (LCA). The requirements for how an EPD is to be made are specified in the ISO 14025 standard. These standardised methods ensure that environmental information can be compared product by product, regardless of manufacturer, region or country. Our EPDs are third-party verified. The GREENGUARD Gold Certification Standard gives assurance that products designed for use in office environments and other indoor spaces meet strict chemical emissions limits, which contribute to the creation of healthier interiors.

1) Included HÅG TiltDown™ armrests

* Based on post consumer recycled PP - Black or Brown. (HÅG Tion and HÅG Celi use post consumer recycled PP for seat & back in all colours)

** Valid for all HÅG Tion models

HÅG Quick-ship

HÅG Quick-ship has been put together for you in order to make it easier to choose model, fabric and colour. In the table below you can see the HÅG Quick-ship combinations. The HÅG Quick-ship collection offers delivery from factory in only 5-10 working days after order has been registered.

MODEL	FABRIC/COLOUR CODE									
	Xtreme Black EXR009	Xtreme Grey EXR081	Select* Black SC60999	Select* Grey SC60134	Nexus Black NEX13	Nexus Grey NEX001	FutuKnit Black FTU099/MEH099	FutuKnit Dusk FTU102/MEH102	Paloma Soft Black ATG56100	
HÅG H03 330	●	●	●							
HÅG Creed 6002	●		●							
HÅG Creed 6003	●		●							
HÅG Creed 6005	●		●							
HÅG Creed 6006	●		●							
Headrest HÅG Creed	●		●							
HÅG Futu 1100 mesh							●	●		
HÅG Futu 1200 solid							●	●		
HÅG Capisco 8106	●	●	●	●					●	
HÅG Capisco 8107	●		●							
HÅG Capisco Puls 8010	●	●			●	●				
HÅG SoFi 7200	●		●							
HÅG SoFi 7300	●		●							
HÅG SoFi 7500	●		●							
Headrest HÅG SoFi	●		●							
HÅG Tribute 9021			●						●	
HÅG Tribute 9031			●						●	
HÅG Conventio 9510			●							

● = Available in HÅG Quick-ship

Please note: to be able to provide this service to all customers, there is a limit of 10 chairs per customer per day. For orders over 10 chairs, please contact Customer Service for delivery details. Please specify that your order is HÅG Quick-ship. During holidays we may not be able to deliver HÅG Quick-ship within the specified time frame. For more information about holiday periods, please contact Customer Service, tel: 99 50 55 00, email: info-dk@flokk.com

HÅG Fabrics and Colours (FutuKnit)

DECORATIVE STITCHING

Decorative stitching can truly add the little extra to your chair.

The 10-colour thread program is available on all textiles for the following HÅG chairs:

- HÅG Capisco model 8105, 8106 and 8107
- Available for all HÅG SoFi models, but only for seat on HÅG SoFi 7500 (with mesh back).

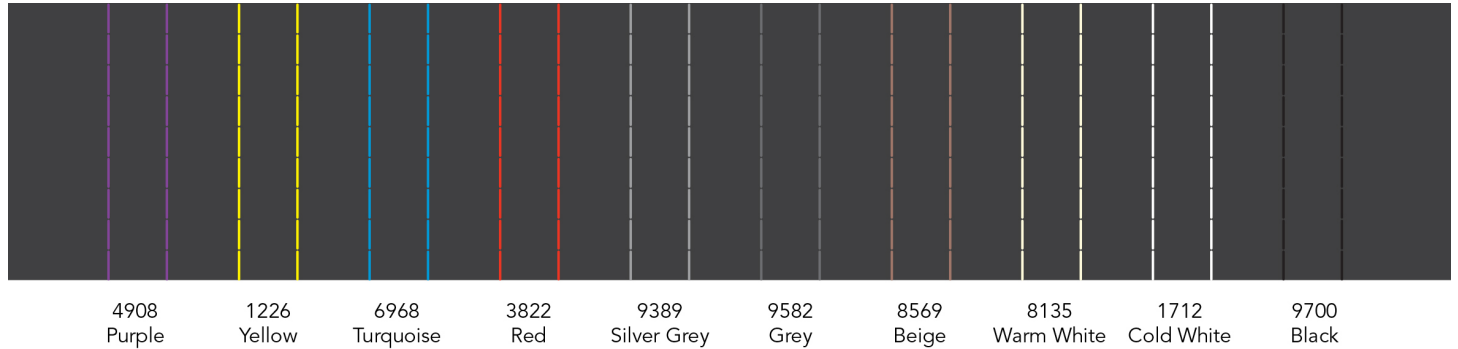

FUTUKNIT™ (CAMIRA) - PRICE GROUP DEPENDS ON CHOICE

The HÅG Futu comes in our two uniquely designed FutuKnit™ fabrics. Made from the finest quality polyester knit, combining aesthetics, ergonomics and flexibility, the 3D knitted fabrics have been technically developed to retain their tautness - providing ultimate support and comfort. By using the technical 3D knitting technique each fabric is knit in one piece that results in no waste. Both the FutuKnit solid and the FutuKnit mesh fabrics are available in seven appealing colours and can be matched. Each colour is inspired by nature.

Composition: 100% polyester

Abrasion: FutuKnit mesh > 200.000 Martindale / FutuKnit Solid > 70.000 Martindale

Flammability: BS EN 1021: 1-2 (Cigarette & match), BS 7176 Low Hazard, CA TB 117-2013

Light fastness: 6 (scale 1-8) (EN ISO 105-B02)

Rubbing fastness: 4-5/4-5 (Wet/Dry) (EN ISO 105X12)

Pilling: 4-5 (BS EN ISO 12945-2)

Environmental facts: EU Ecolabel, Oeko-Tex® Standard 100, 100% free of heavy metals, ISO 14001 certified company

Design: Camira Technical Knitting team & Flokk Design team

Produced in: United Kingdom

Cleaning & disinfection: Bleach cleanable (For further info follow Camira's cleaning guidelines - www.camirafabrics.com)

FutuKnit mesh (MEH) for back and FutuKnit solid (FTU) for seat or seat&back by Camira Fabrics are only available for the HÅG Futu collection.

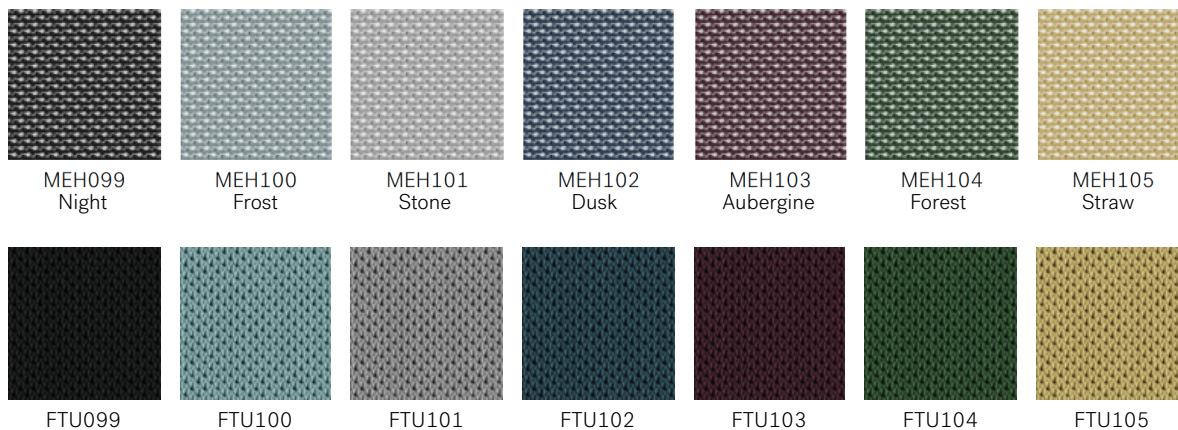

HÅG Fabrics and Colours PLASTIC & METAL

HÅG TION



HÅG Tion - Focus collection



S = Standard
E = Extended

*Additional prices apply
** Colour variations between batches may occur

HÅG CAPISCO PULS



Matching colours for HÅG Capisco Puls

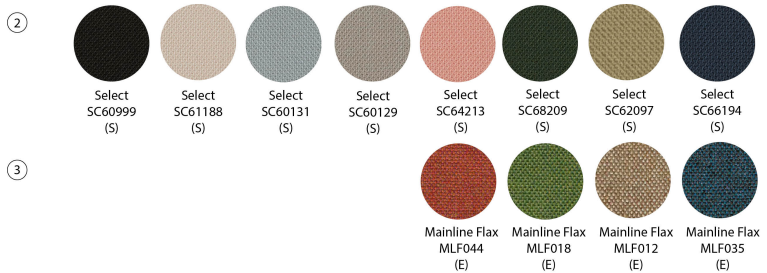

S = Standard
E = Extended

*Colour variations between batches may occur

HÅG CONVENTIO WING

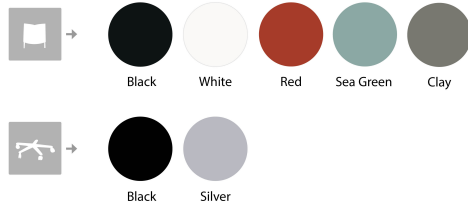

Matching colours for
HÅG Conventio Wing



S=Standard
E=Extended

HÅG CELI

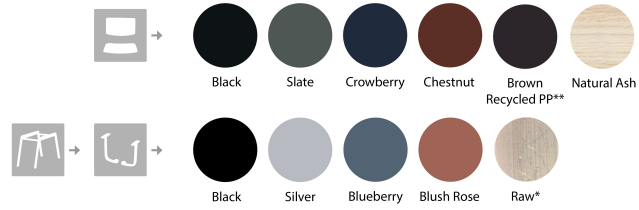

* Raw finish: due to the production process, lines, scratches and colour changes are natural part of this finish
 ** Colour variations between batches and/or minor visual imperfections may occur on some surface areas

CELIKMIT (GABRIEL)

Celikmit is a 3D shape-knitted upholstery, specially made to fit the back and seat of HÅG Celi plastic chairs. It has a comfy expression with its chunky feel and soft touch. The knit is made of 100% recycled polyester in yarn and filling. Designed with an alternating herringbone pattern effect playing with light and depth. The colour range is primarily monochromatic with some subdued colour blends. All colours matching or nicely combines with the HÅG Celi plastic and metal colours. These knitted covers are easily removable and replaceable.

Composition: 100% recycled polyester

Abrasion resistance: 60000 Martindale (EN ISO 12947-2)

Flammability: BS EN 1021: 1-2 (Cigarette & match), CA TB 117-2013

Light fastness: 8 (EN ISO 105-B02)

Rubbing fastness: 4-5/4-5 (Wet/Dry) (EN ISO 105X12)

Pilling: 5 (EN ISO 12945-2)

Environmental facts: EU Ecolabel, 100% free of heavy metals and harmful chemicals, ISO 14001 certified company

Design: Gabriel Design team, Gudrun Reikvam /Flokk Design team

Produced in: Lithuania

Cleaning: Professional dry cleaning (For further info follow Gabriel´s cleaning guidelines: Gabriel_ Stain_guide_Shapeknit- www.gabriel.dk)

CLK70999 (Black) & 70770 (Crowberry) = S

CLK70220 (Harvest), 70450 (Chestnut), 70660 (Blueberry) & 70870 (Moss) = E

S=Standard Collection - normal delivery time from factory 10-15 working days.

E= Extended Collection - normal delivery time from factory 25-30 working days.

For larger orders, please contact Customer Service for delivery details.



CLK70999

CLK70870

CLK70770

CLK70660

CLK70450

CLK70220

HÅG SOFI

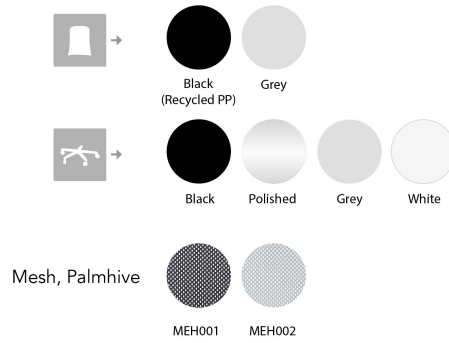

MESH (PALMHIVE) - PRICE GROUP DEPENDS ON CHOICE

A warp knitted heavy duty mesh, using an innovative yarn construction to give increased strength which provides enhanced comfort, support and appearance. Its structure is soft and comforting with a semi-transparent effect. The mesh is available in black and light grey. Easy to combine with many fabrics and colours from the Standard collection.

Composition: 100% polyester

Abrasion resistance: 150.000 Martindale

Flammability: BS EN 1021: 1 -2: 2014

Light fastness: 5 (EN ISO 105-B02)

Rubbing fastness: 4/4 (Wet/Dry) (EN ISO 105X12)

Pilling: 4-5 (EN-ISO 12945-2)

Environmental facts: Oeko-Tex® Standard 100

Produced in: United Kingdom

Mesh by Palmhive is only available for the back of HÅG SoFi 7500 and 7502

HÅG Standard fabrics & colour collection 2024

CURA (GABRIEL) - PRICE GROUP 1

Cura is a two-coloured fabric made from 98% post-consumer recycled polyester. It has a matt, slightly irregular and natural-looking texture where the dark, underlying grey fibers create a discreet yet vibrant melange effect. High durability and stretchability and its soft, voluminous touch make Cura suitable for both office and lounge furniture.

Composition: 100% post-consumer recycled polyester

Weight: 420 g/lm

Abrasion resistance: 100 000 Martindale (EN ISO 12947-2)

Flammability: BS EN 1021: 1-2, BS 5852 0&1, CA TB 117-2013, ASTM E 84 Class I

Light fastness: 5-8 (EN ISO 105 - B02)

Rubbing fastness: 4-5/4-5 (Wet/Dry) (EN ISO 105X12)

Pilling: 4-5 (EN ISO 12945-2)

Environmental facts: EU Ecolabel, Oeko-Tex® Standard 100, Contains no Flame Retardant chemicals, ISO 14001 certified company

Design: Cenk Kivrikoglu

Produced in: Lithuania

Cleaning: Wash or dry cleaning, Can be disinfected with ethanol and is bleach-cleanable (For further info follow Gabriel´s cleaning guidelines - www.gabriel.dk)

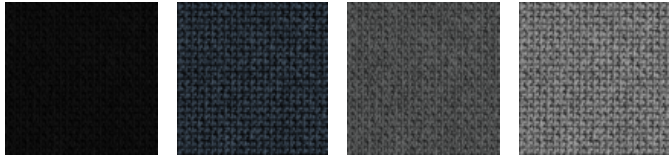

CU60999

CU66165

CU60109

CU60110

XTREME (CAMIRA) - PRICE GROUP 1

Xtreme is a crepe fabric made from 100% post-consumer recycled polyester that features exceptional Euro flammability performance. Extra stretch and structure gives an irregular, shiny finish.

Composition: 100% post-consumer recycled polyester

Weight: 310 g/m²

Abrasion resistance: >100 000 Martindale (EN ISO 12947-2)

Flammability: BS EN 1021: 1-2 (Cigarette & match), BS 7176 Low & Medium Hazard, BS 5852 Section 4 Crib 5, DIN 4102 B1, UNI 9175 Class 1 IM, NF D 60-013

Light fastness: 6 (EN ISO 105 - B02: 2013)

Rubbing fastness: 4/4 (Wet/Dry) (EN ISO 105X12)

Pilling: 5 (EN ISO 12945-2)

Environmental facts: EU Ecolabel, Oeko-Tex® Standard 100, Indoor Advantage™ "Gold", non metallic dyestuffs, ISO 14001 certified company.

Design: Camira Design Studio

Produced in: United Kingdom

Cleaning & disinfection: Washable to 60 °C and bleach cleanable (For further info follow Camira's cleaning guidelines - www.camirafabrics.com)

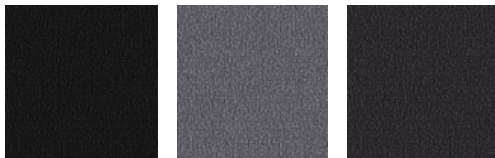

EXR009

EXR081

EXR145

SELECT (GABRIEL) - PRICE GROUP 2

Select is a classic woolen fabric with a tightly woven relief structure, combining excellent softness, stretch and durability. Its rich texture with the interplay of light and shadow add depth in all the colours in the palette.

Composition: 85% New Zealand wool, 15% polyamide

Abrasion resistance: 200 000 Martindale (EN ISO 12947-2)

Flammability: BS EN 1021: 1-2, BS 5852 0&1, BS5852 Crib 5, CA TB 117-2013, IMO MSC 307(88) Annex 1 part 8/MED registration IMO

Light fastness: 5-8 (EN ISO 105 - B02)

Rubbing fastness: 4-5/4-5 (Wet/Dry) (EN ISO 105X12)

Pilling: 4 (EN ISO 12945-2)

Environmental facts: EU Ecolabel, Oeko-Tex® Standard 100, 100% free of heavy metals, ISO 14001 certified company

Design: Cenk Kivrikoglu

Produced in: Lithuania

Cleaning: Professional dry cleaning (For further info follow Gabriel's cleaning guidelines - www.gabriel.dk)

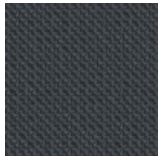

SC60003

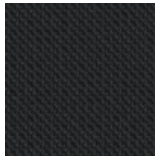

SC60051

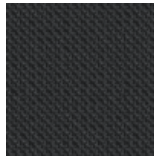

SC60134

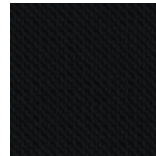

SC60999



SC66194

SC61186



SC61184

SC60139



SC66071



SC62097

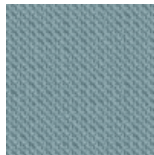

SC67098

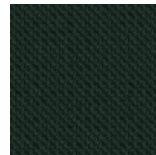

SC68209

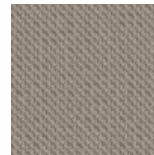

SC60129

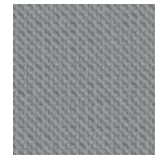

SC60131

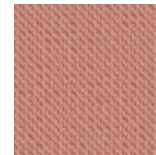

SC64213



SC61188

CAPTURE (GABRIEL) - PRICE GROUP 3

Capture is a lightly felted and multi-coloured wool fabric combining softness, stretch and strenght. It fuses light and dark colours to a refined melange pattern in subtle nuances, which add richness and depth to the design.

Composition: 85% New Zealand wool, 15% polyamide

Abrasion resistance: 200.000 Martindale (EN ISO 12947-2)

Flammability: BS EN 1021: 1-2 (Cigarette & match), BS 5852 Part 1 0,1 (Cigarette & match), CA TB 117-2013, Class Uno UNI 9175 Class 1 IM

Light fastness: 5-7 (EN ISO 105-B02)

Rubbing fastness: 4-5/4-5 (Wet/Dry) (EN ISO 105X12)

Pilling: 4-5 (EN-ISO 12945-2)

Environmental facts: EU Ecolabel, Oeko-Tex® Standard 100, 100% free of heavy metals, ISO 14001 certified company

Design: Cenk Kivrikoglu

Produced in: Lithuania

Cleaning: Professional dry cleaning (For further info follow Gabriel's cleaning guidelines - www.gabriel.dk)

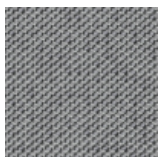

CPT4102

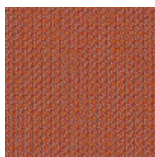

CPT4301

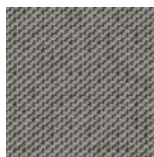

CPT4401

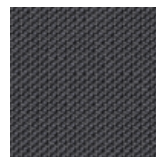

CPT4601

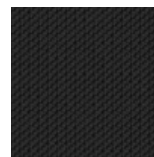

CPT5501

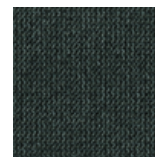

CPT6601

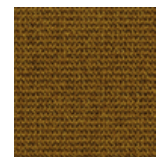

CPT6401

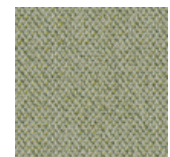

CPT5101

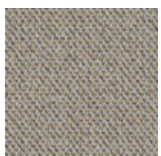

CPT5103

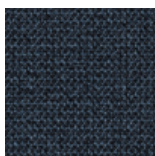

CPT6001

FOCUS (GABRIEL) - PRICE GROUP 3

Focus is a woven felt fabric made of 100% long-staple worsted wool. It has an ultra soft and satiny touch combined with high strength obtained by use of high-quality worsted wool yarn and careful production processes. In addition to high durability, the fabric does not pill and will remain attractive over time regardless of wear and tear.

Composition: 100% New Zealand wool

Weight: 660 g/lm

Abrasion resistance: 100 000 Martindale (EN ISO 12947-2)

Flammability: BS EN 1021: 1-2 (Cigarette & match), BS 5852 Part 1 0.1 Cigarette and match, CA TB 117-2013, Class Uno UNI 9175 Class 1 I EMME, ÖNORM A33800-B1-B33825-Q1UK, AM 18 - NF D 60-013-(only for fabric)

Light fastness: 5-7 (EN ISO 105-B02)

Rubbing fastness: 4-5/4-5 (Wet/Dry) (EN ISO 105X12)

Pilling: 4 (EN ISO 12945-2)

Environmental facts: EU Ecolabel, Free of heavy metals and harmful chemicals, biodegradable, Oeko-Tex® Standard 100, ISO 14001 certified company

Design: Inger Mosholt Nielsen, colours Cenk Kivrikoglu

Produced in: Lithuania

Cleaning: Professional dry cleaning (For further info follow Gabriel´s cleaning guidelines – www.gabriel.dk)

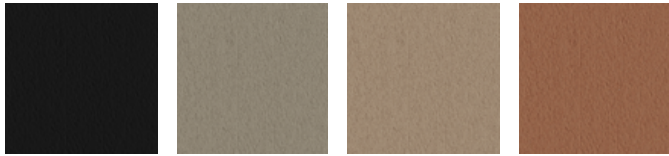

FC60999

FC61042

FC61039

FC61036

FOCUS MELANGE (GABRIEL) - PRICE GROUP 3

Focus Melange is a woven felt fabric made of 100% long-staple worsted wool. It has an ultra soft and satiny touch combined with high strength obtained by use of high-quality worsted wool yarn and careful production processes. In addition to high durability, the fabric does not pill and will remain attractive over time regardless of wear and tear. The equal thickness between the warp and weft yarn give a harmonious and symmetric melange colour expression.

Composition: 100% New Zealand wool

Weight: 660 g/lm

Abrasion resistance: 100 000 Martindale (EN ISO 12947-2)

Flammability: BS EN 1021: 1-2 (Cigarette & match), BS 5852 Part 1 0.1 Cigarette and match, CA TB 117-2013, Class Uno UNI 9175 Class 1 I EMME, ÖNORM A33800-B1-B33825-Q1UK

Light fastness: 5-7 (EN ISO 105-B02)

Rubbing fastness: 4-5/4-5 (Wet/Dry) (EN ISO 105X12)

Pilling: 4 (EN ISO 12945-2)

Environmental facts: EU Ecolabel, Free of heavy metals and harmful chemicals, biodegradable, Oeko-Tex® Standard 100, ISO 14001 certified company

Design: Inger Mosholt Nielsen, colours Cenk Kivrikoglu

Produced in: Lithuania

Cleaning: Professional dry cleaning (For further info follow Gabriel´s cleaning guidelines – www.gabriel.dk)

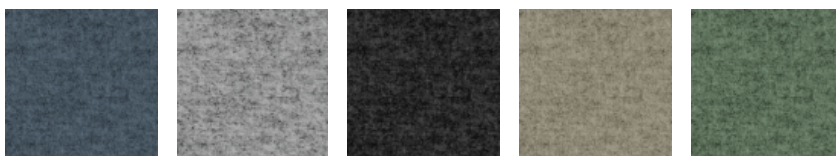

FCM60308

FCM60310

FCM60900

FCM61240

FCM68247

NEXUS (CAMIRA) - PRICE GROUP 3

Nexus is a polyester knit, offering a two dimensional stretch in a pinprick dot matrix design effect.

Composition: 100% polyester

Abrasion resistance: > 100.000 Martindale (EN ISO 12947-2)

Flammability: BS EN 1021: 1-2 (Cigarette & match), BS 7176 Low Hazard, UNI 9175 Class 1 IM

Light fastness: 5 (EN ISO 105 - B02)

Rubbing fastness: 4/4 (Wet/Dry) (EN ISO 105X12)

Pilling: 4/5 (EN ISO 12945-2)

Environmental facts: Oeko-Tex® Standard 100, Indoor Advantage™ "Gold", 100% free of heavy metals, ISO 14001 certified company

Design: Camira Design Studio

Produced in: Spain

Cleaning & disinfection: Washable to 60 °C and bleach cleanable. (For further info follow Camira's cleaning guidelines - www.camirafabrics.com)



NEX001

NEX011

NEX013

NEX007

NOTE (GABRIEL) - PRICE GROUP 3

Note is a soft and lustrous worsted wool with a classic satin structure. It's sleek design highlights the furniture's shape and sharpens its silhouette.

Composition: 85% New Zealand wool, 15% polyamide

Abrasion resistance: 200 000 Martindale (EN ISO 12947-2)

Flammability: BS EN 1021: 1-2 (Cigarette & match), BS 5852 0&1, BS 5852 crib 5, IMO MSC 307 (88) Annex 1 part 8, CA TB 117-2013

Light fastness: 5-8 (EN ISO 105 - B02)

Rubbing fastness: 4/4-5 (Wet/Dry) (EN ISO 105X12)

Pilling: 4 (EN ISO 12945-2)

Environmental facts: EU Ecolabel, Oeko-Tex® Standard 100, 100% free of heavy metals, ISO 14001 certified company

Design: Inger Mosholt Nielsen

Produced in: Lithuania

Cleaning: Professional dry cleaning (For further info follow Gabriel's cleaning guidelines - www.gabriel.dk)

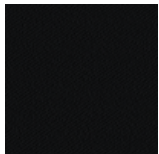

NT60999

OCEANIC (CAMIRA) - PRICE GROUP 3

Oceanic is made from 100 % post-consumer recycled polyester yarn where 90% are created from post-consumer plastic bottles diverted from landfill and 10% is upcycled marine plastic(from marine litter). It is a fabric born out of the SEAQUAL Initiative designed to combat marine plastic pollution and achieve a waste free environment. Oceanic has a two coloured diagonal structure with a matte surface and soft touch.

Composition: 100 % post-consumer recycled polyester, including 50% SEAQUAL yarn

Weight: 497 g/m² ±5%

Abrasion resistance: >100 000 Martindale (EN ISO 12947-2)

Flammability: BS EN 1021: 1-2 (Cigarette & match), BS 7176 Low, BS 7176 Medium Hazard with EnviroFlam5, CA TB 117-2013

Light fastness: 5 (EN ISO 105 - B02: 2013)

Rubbing fastness: 4/4 (Wet/Dry) (EN ISO 105X12)

Pilling: 4 (EN ISO 12945-2)

Environmental facts: EU Ecolabel, Oeko-Tex® Standard 100, Indoor Advantage™ "Gold", non metallic dyestuffs, ISO 14001 certified company.

Design: Camira Design Studio

Produced in: United Kingdom

Cleaning & disinfection: Washable at 60 °C and bleach cleanable (For further info follow Camira´s cleaning guidelines – www.camirafabrics.com)

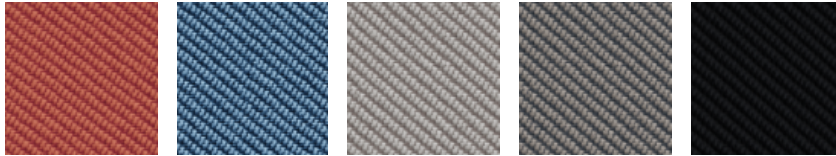

OCI012

OCI011

OCI014

OCI008

OCI001

PUXX 1 (ONIRO) - PRICE GROUP 3

PUxx 1 is a polyurethane leather with a soft touch that is easy to clean and disinfect. It is 100% waterproof, antibacterial & antifungal and resistant towards blood and urine. Being strong, durable and easy to maintain make it well suited for environments with high cleaning requirements.

Composition: Coating: 100% polyurethane with a cotton/polyester backing

Weight: 520 g/m²

Abrasion resistance: 300 000 Martindale (EN 530-2 (2010))

Flammability: BS EN 1021: 1-2 (Cigarette & match), CA TB 117-2013, BS 5852:2006 Crib 5, IMO 2010 FTP Code Annex 1 part 8

Light fastness: 6-7 (EN ISO 105-B02)

Rubbing fastness: 4-5/4-5 (Wet/Dry) (EN ISO 105X12.2016)

Environmental facts: Oeko-Tex® Standard 100, 100% free of heavy metals and harmful chemicals, ISO 14001 certified company

Design: Oniro Design team

Produced in: Belgium

Cleaning: Alcohol, hydrogen peroxide & chlorine solutions. Never use solvents. For more info please contact supplier www.oniro.nl

PUxx 1 is not available for HÅG Conventio models 9510/9511/9512.

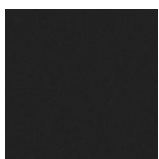

PU215816

ILLUSION (NEVOTEX) - PRICE GROUP 4

Illusion is a resistant easy cleanable synthetic leather with a polyurethane (PU) coating on a cotton backing. It has a semi matte surface with a softly grained structure and is recommended to use in environments with high cleaning demands.

Composition: Coating: 100% Polyurethane, Backing: 100% Cotton

Weight: 595 ± 30 g/m²

Abrasion resistance: 500 000 Martindale (EN ISO 5470-2:2003)

Flammability: BS EN 1021: 1-2 (Cigarette & match), CA TB 117-2013, BS 5852:2006 Crib 5, DiN 4102-1B2:1998 (B2), IMO 2010 FTP Code Annex 1 part 8

Light fastness: >7 (EN ISO 105-B02)

Rubbing fastness: 4-5/4-5 (Wet/Dry) (EN ISO 105X12.2016)

Surface resistance: 4-5 (EN12720)

Environmental facts: Oeko-Tex® Standard 100, Free of heavy metals and harmful chemicals, ISO 14001 certified company

Design: Nevotex Design team

Produced in: Belgium

Cleaning: Alcohol (75%), hydrogen peroxide & chlorine. For specific recommendations please contact supplier www.nevotex.com

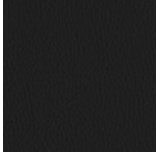

ILU110

SIRDAL (GU) - PRICE GROUP 4

Sirdal is part of the 100% Norwegian wool trio Sirdal, Suldal and Setesdal. These fabrics are uniquely short-travelled in every part of the process – 100% pure Norwegian wool manufactured in Norway. Norwegian wool with its distinctive brilliance, resilience and durability is expressed through rich structures that evoke authenticity paired with chic and modern comfort.

Composition: 100% Virgin Norwegian wool

Weight: 800 g/m

Abrasion resistance: 56 000 Martindale (EN ISO 12947-2)

Flammability: BS EN 1021: 1-2 (Cigarette & match), IMO FTP code 2010: Part 8

Light fastness: 5-7 (EN ISO 105-B02)

Rubbing fastness: 4/4-5 (Wet/Dry) (EN ISO 105X12)

Pilling: 3-4 (EN ISO 12945-2)

Environmental facts: Locally produced, 100% free of heavy metals, ISO 14001 certified company

Design: GU design team/Ragnhild Nordhagen, Flokk Design team/Pernille Stoltze

Produced in: Norway

Cleaning: Professional dry cleaning (For further info follow GU's cleaning guidelines – www.gu.no)

Sirdal is not available for HÅG Capisco Puls models 8001/8010.



SRD120

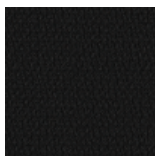

SRD190



SRD320



SRD480



SRD630



SRD730



SRD780



SRD960

SULDAL (GU) - PRICE GROUP 4

Suldal is a melange fabric, part of the 100% Norwegian wool trio Sirdal, Suldal and Setesdal. These fabrics are uniquely short-travelled in every part of the process – 100% pure Norwegian wool manufactured in Norway. Norwegian wool with its distinctive brilliance, resilience and durability is expressed through rich structures that evoke authenticity paired with chic and modern comfort.

Composition: 100% Virgin Norwegian wool

Weight: 800 g/m

Abrasion resistance: > 56 000 Martindale (EN ISO 12947-2)

Flammability: BS EN 1021: 1-2 (Cigarette & match), IMO FTP code 2010: Part 8

Light fastness: 5-7 (EN ISO 105-B02)

Rubbing fastness: 4/4-5 (Wet/Dry) (EN ISO 105X12)

Pilling: 3-4 (EN ISO 12945-2)

Environmental facts: EU Ecolabel, Locally produced, Biodegradable, 100% free of heavy metals, ISO 14001 certified company

Design: GU Design Team/Ragnhild Nordhagen, Flokk Design Team/Pernille Stoltze

Produced in: Norway

Cleaning: Professional dry cleaning (For further info follow GU´s cleaning guidelines – www.gu.no)

Suldal is not available for HÅG Capisco Puls models 8001/8010,

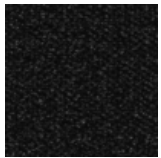

SUL180

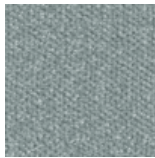

SUL810

STEELCUT TRIO 3 (KVADRAT) - PRICE GROUP 4

Steelcut Trio 3 is a strong worsted wool and polyamide woven fabric, made with three different coloured yarns. The colours and the special weave create a three-dimensional surface where the colours seem to change depending on the angle of perspective. Like Steelcut 3, despite the complexity of the textile's innovative weave, it has a simple, precise expression.

Composition: 90% worsted new wool, 10% polyamide

Weight: 770 g/lm

Abrasion resistance: 100 000 Martindale (EN ISO 12947-2)

Flammability: BS EN 1021: 1-2 (Cigarette & match, CA TB 117-2013, , BS 5852 Crib 5 (with treatment), BS 5852 part 1, BS 5852 ignition source 3, IMO FTP Code 2010 Part 8, NF D 60 013, NFPA 260, UNI 9175 1IM, ÖNORM B1/Q1, AS/NZS 3837 Class 2, GB 50222 B1 with treatment (Chinese)

Light fastness: 6-7 (EN ISO 105-B02)

Rubbing fastness: 3-5/4-5 (Wet/Dry) (EN ISO 105X12)

Pilling: 4 (EN ISO 12945-2)

Environmental facts: EU Ecolabel, 100% free of heavy metals, ISO 14001 certified company, GREENGUARD Gold

Design: Frans Dijkmeijer, Giulio Ridolfo (updated colourways)

Produced in: United Kingdom

Cleaning: Professional dry cleaning with tetrachloroethylene, normal process (For further info follow Kvadrat´s cleaning guidelines – www.kvadrat.dk)

Steelcut Trio 3 is not available for HÅG Capisco Puls models 8001/8010.

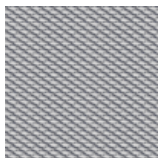

STT133

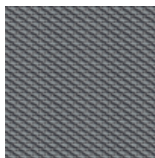

STT153

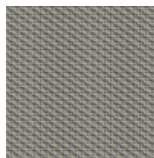

STT253

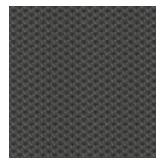

STT383

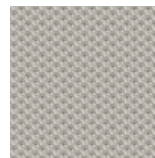

STT213

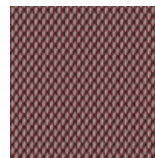

STT645

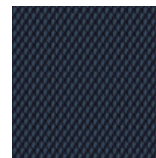

STT796

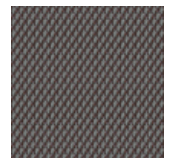

STT276

STEELCUT 3 (KVADRAT) - PRICE GROUP 4

Steelcut 3 is a unicoloured strong worsted wool and polyamide woven fabric, combining durability, soft touch and colour depth. The construction creates a three-dimensional surface resembling small pyramids or steel points. Despite its complex weaving technique, it has a simple and precise expression.

Composition: 90% worsted new wool, 10% polyamide

Weight: 825 g/lm

Abrasion resistance: 100 000 Martindale (EN ISO 12947-2)

Flammability: BS EN 1021: 1-2 (Cigarette & match, CA TB 117-2013, BS 5852 Crib 5 (with treatment), BS 5852 part 1, IMO FTP Code 2010 Part 8, NF D 60 013, NFPA 260, UNI 9175 1IM, ÖNORM B1/Q1, AS/NZS 3837 Class 2, ASTM E84 Class A Unadhered, ASTM 84 Class B Adhered

Light fastness: 5 6 (EN ISO 105-B02)

Rubbing fastness: 3-5/4-5 (Wet/Dry) (EN ISO 105X12)

Pilling: 3-4 (EN ISO 12945-2)

Environmental facts: EU Ecolabel, 100% free of heavy metals, ISO 14001 certified company, GREENGUARD Gold

Design: Frans Dijkmeijer, Giulio Ridolfo (updated colourways)

Produced in: United Kingdom

Cleaning: Professional dry cleaning with tetrachloroethylene, normal process (For further info follow Kvadrat's cleaning guidelines - www.kvadrat.dk)

Steelcut 3 is not available for HÅG Capisco Puls models 8001/8010.

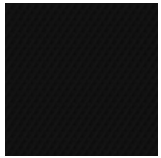

STT190

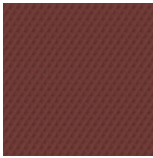

STT655

PALOMA SOFT (WOLLSDORF) - PRICE GROUP 6

High quality semi-aniline leather. All our standard colours from Paloma have a special finish adding a particular softness to the leather. Excellent friction and breathing properties. The surface may feature small scars and marks resulting from insect bites etc. These are proof of the natural origin of the product and are part of its character.

Flammability: BS EN 1021: 1-2 (Cigarette & match), BS 5852 Crib 5, IMO A.652 (16)

Light fastness: 6 (EN ISO 105-B02)

Rubbing: Wet 80/4 -Dry 2000/4 - Sweat 50/4 - ISO 11640

Finish-adhesion: 2,0 N/cm ISO 11644

Tear-strength: 20 N/mm DIN 53329- A

Environmental facts: Tanned without using chromium salts, BlueAngel, ECO2L-certificate, ISO 14001 certified company

Produced in: Austria

Animal Welfare: All hides are by-products from the meat and dairy industries, only use hides from healthy and uninjured animal. Following European standards as a minimum and the "Five Freedoms" of livestock as defined by FAWC (Farm Animal Welfare Council)

Cleaning: Follow the leather care guide from our supplier - www.wollsdorf.com

Paloma Soft is not available for HÅG Tion model 2160 and HÅG Conventio Wing.



ATG55115

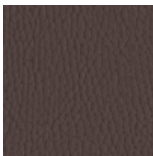

ATG55130

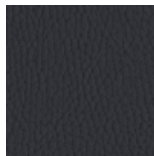

ATG55185

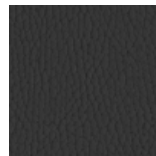

ATG56100

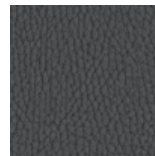

ATG55206

ELMOSOFT (ELMO) - PRICE GROUP 7

Elmosoft is a chrome free supreme quality semi-aniline grain leather from Scandinavian cattle. It is soft and pliable with an outstanding comfort and durability. Visible insect-bites and scars from healed wounds add to the authentic quality and character of the leather.

Thickness: 1.1 - 1.3 mm

Flammability: BS EN 1021: 1-2 (Cigarette & match), BS 5852 Crib 5, CA TB 117-2013, DIN 4102 -1 (B1), IMO 2010 FTP Code Part 8 (IMO652), UNI 9175, Önorm B 3825, UNI 9175

Light fastness: 6 (EN ISO 105-B02)

Rubbing: Wet 80/4 - Dry 2000/4 - Sweat 50/4 - ISO 11640

Finish-adhesion: ≥ 2 N/cm - ISO 11644

Tear-strength: ≥ 20 N/cm DIN 53329-A

Environmental facts: Free of heavy metals, tanned without using chromium salts, ISO 14001 certified company, Clean water tanning technology with biological Water Treatment Plant and 100% CO2 neutral on energy.

Animal Welfare: All hides are by-products from the meat and dairy industries with traceability back to the farm. Following strict regulations on animal welfare in compliance with national and international standards as those issued by the World Organization for Animal Health (6 animal welfare freedoms)

Produced in: Sweden

Cleaning: (Follow the guidelines by our supplier – www.elmoleather.com)

Elmosoft is not available for HÅG Conventio Wing.



EL99999



EL33004

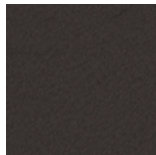

EL93068

Curated Fabric & Colour Collection

FLOKK & KVADRAT CURATED COLLECTION

Flokk & Kvadrat Curated Collection is a carefully selected collection of textiles and colours chosen to provide more specific and inspiring choices for our customers.

The assortment consists of four different ranges of textiles in a variety of colours and textures – each with distinct features and expressions.

The textile and colour diversity reflects high design and quality and meets the technical and environmental requirements for office interiors and public spaces.

For technical specification, product description and colour overview see website and colour card.

Curated textiles and colours in price group 3:

- **Atlas:** 131, 461, 501, 531, 571, 671, 731, 781, 911, 981
- **Re-Wool:** 128, 198, 448, 458, 558, 568, 628, 648, 718, 758, 768, 858

Curated textiles and colours in price group 4:

- **Melange Nap:** 111, 171, 191, 211, 241, 371, 411, 521, 651, 751, 911, 951

Curated textiles and colours in price group 5:

- **Twill Weave:** 190, 280, 430, 530, 780, 940, 990

For more information see our website: [Flokk and Kvadrat Curated Collection](#)



Extended Fabric & Colour Collection

With minimum 5 year guarantee

If you cannot find what you are looking for in our Standard collection, we offer a comprehensive range in our Extended collection. We offer a 10 year warranty on Xtreme, Cura, Oceanic, Focus, Focus Melange, Select, Capture, Sirdal, Suldal, Steelcut 3, Steelcut Trio 3, Nexus, Paloma Soft and Elmosoft. We offer a 5 year warranty on our polyurethane coated fabrics Illusion and PUxx 1. For more details on our warranty please see page 4. Dispatch time from factory on Extended fabrics is usually 25 - 30 working days provided fabric is available from our suppliers stock.



SUPPLIER/COLLECTION	PRICE GROUP	SUPPLIER/COLLECTION	PRICE GROUP	SUPPLIER/COLLECTION	PRICE GROUP
Camira Fabrics - www.camirafabrics.com		GU - www.gu.no		Ludvig Svensson - www.ludvigsvensson.com	
24/7+ ⁵⁾	3	Amdal ⁵⁾	4	Balance ⁵⁾	5
24/7 Flax ⁵⁾	3	Bardal	4	Debut ⁵⁾	5
Blazer	3	Gandal+ ⁵⁾	4	Heritage Blend	4
Craggan Flax ⁵⁾	4	Heidal ⁵⁾	4	Heritage Botany	4
Era	3	Hemsedal ⁵⁾	5	Heritage Medio	4
Gravity	3	Herringdal	4	Heritage Tailor	4
Main Line Flax	3	Lyngdal ⁵⁾	5	Heritage Tuck	4
Main Line Twist	3	Mandal	3	Ink	4
Nexus ¹⁾	3	Morgedal ⁵⁾	4	Khaki (Trevira CS)	3
Oceanic ¹⁾	3	Redal ⁵⁾	4	Node	3
Quest	3	Romsdal ⁵⁾	4	Rami Plus	5
RePlay	3	Setesdal ⁵⁾	4	Semi	3
Revolution ⁵⁾	4	Sirdal ^{1) 5)}	4	Step ⁵⁾	4
Rivet	3	Suldal ^{1) 5)}	4		
Sprint	3			Nevotex - www.nevotex.se	
Sumi	4	Hornschuch - www.skai.com		Antistatic synthetic leather (vinyl) (ESD) ⁽³⁾	3
Synergy	3	Evida (vinyl) ^{5) 6)}	3	Illusion ¹⁾ (polyurethane)	4
Urban	3			Illusion Full Grain (polyurethane)	4
Xtreme ¹⁾	3	Kvadrat - www.kvadrat.dk			
Yoredale ⁵⁾	5	Atlas ²⁾	3		
		Canvas ^{2) 7)}	4	Oniro - www.oniro.nl	
		Clara ²⁾	4	PUxx ^{1) 10)} (polyurethane)	3
		Coda ^{2) 5)}	OR	PUxx ^{2) 10)} (polyurethane)	3
Elmo - www.elmoleather.com		Divina ³⁾	5		
Elmosoft ^{1) 9)}	OR	Divina MD	5	Spradling - www.spradling.eu	
Elmosoft Piqué ^{3) 5) 9)}	OR	Divina Melange ³⁾	5	Dolce (polyurethane) ⁸⁾	4
		Encircle	5	Valencia (vinyl) ⁵⁾	3
		Fiord ²⁾	4		
Gabriel - www.gabriel.dk		Foss	5	Vescom - www.vescom.com	
Breeze Fusion	4	Hallingdal ^{6) 5)}	5	Gamut	4
Capture ¹⁾	3	Jaali	5		
Comfort+ (polyester & polyurethane) ³⁾	5	Melange Nap ^{2) 5)}	4	Wollsdorf - www.wollsdorf.com	
Connect ⁵⁾	3	Naveli	4	Paloma ^{7) 9)}	OR
Crisp	3	Raas ⁵⁾	5		
Cura ¹⁾	3	Razzle Dazzle	6		
Fame	3	Recheck	4		
Focus ¹⁾	3	Remix ^{3) 3) 7)}	3		
Focus Melange ¹⁾	3	Re-Wool ²⁾	3		
Focus Royal ⁵⁾	3	Sisu ⁴⁾	6		
Gaja C2C	3	Steelcut ^{3) 1) 5)}	4		
Gaca Classic	3	Steelcut Trio ^{3) 1) 5)}	4		
Go Check (Trevira CS)	3	Steelcut Quartet ⁵⁾	5		
Harmony	3	Sunniva	5		
Lense	3	Tonus ^{4) 5)}	5		
Morph	3	Twill Weave ^{2) 5)}	5		
Renewed Loop	3	Vidar ^{4) 5)}	6		
Rondo	3				
Select ¹⁾	2				
Step (Trevira CS)	3				
Step Melange (Trevira CS)	3				
Tonal ⁵⁾	3				
Umber	3				

- 1) Non-standard colours
 - 2) Non-curated colours
 - 3) Not available for HÅG Tribute
 - 4) Only for HÅG Tion/Capisco/Capisco Puls 8002&8020/Creed 6056&6172
 - 5) Not available for HÅG Capisco Puls 8001, 8010
 - 6) Not available for HÅG Inspiration
 - 7) Not available for HÅG Tion 2160
 - 8) Not available for HÅG Capisco Puls 8002, 8020
 - 9) Not available for HÅG Conventio Wing
 - 10) Not available for HÅG Conventio 9510, 9511, 9512
- OR = On request

HÅG SEAT/BACK COLOURS & MATERIALS – MATRIX

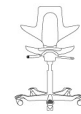

	HÅG Tion 2100/2140/2160	HÅG Tion 2200/2240	HÅG Celi 9100/9140/9160	HÅG Celi 9200/9240	HÅG Capisco Puls	HÅG Conventio Wing
Moss (RAL 6013)	● *				●	
Rosehip					●	
Blush (RAL 040 50 30)	● *					
Chestnut (RAL 8015)	● *		● *			
Brown (Snow Plough)	● **		● **		● **	
Crowberry (RAL 5011)	● *		● *			
Blueberry					●	
Harvest	● *					
Mist (RAL 7047)	● *					
Sand					●	
Slate (RAL 7012)			● *			
Light grey					●	
Clay					●	●
White (RAL 9003)					●	●
Black (RAL 9005)	● *		● *		● *	●
Sea Green						●
Red						●
Ash wood		●				
Natural Ash - wood veener				●		

* Recycled PP

** Recycled PP from Snow Plough markers. Colour variations between batches may occur.

HÅG FRAME COLOURS – MATRIX

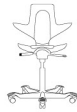

	HÅG Tion	HÅG Celi	HÅG Capisco Puls	HÅG Capisco	HÅG Conventio Wing
Moss Grey (RAL 6013)	●		●	●	
Blush Rose (RAL 040 50 30)	●	●	●	●	
Blueberry		●			
Silver (RAL 9006)	●	●	●	●	●
Raw		●			
White (RAL 9016)	●		●	●	
Black (RAL 9005)	●	●	●	●	●
Polished Aluminium	●		●	●	
Tumbled Aluminium	●				



Flokk is the leading manufacturer of high-quality workplace furniture in Europe, with a strong foothold in North America, developing a growing family of global brands. We are the proud owner of product brands HÅG, Offecct, Giroflex, RH, Profim, Stylex, 9to5 Seating, Connection and Malmstolen. A structured focus on the environment through several decades has enabled us to be a leader in the development of sustainable furniture.

Our head office is in Oslo, Norway, with main production sites in Røros (Norway), Nässjö (Sweden), Turek (Poland), Huddersfield (UK) Delanco NJ (USA) and Hawthorne CA (USA). In addition, we keep sales offices in Norway, Sweden, Denmark, Germany, Belgium, the Netherlands, UK, France, Switzerland, Singapore, USA, Canada, China and Australia. Flokk products are sold in more than 80 countries worldwide. About 1800 employees work together to realise the vision of Flokk:
Inspire great work.

Flokk A/S
Sorgenfrivej 18
DK - 2800 Kongens Lyngby

Phone: +45 99 50 55 00
E-mail: info-dk@flokk.com
www.flokk.com

Front page
Chair models: HÅG Capisco 8106
Photo: Margaret M. de Lange