

Price List

Valid from the 1st of March 2025
edition 1

All prices: DKK

Contents

Order entry specifications	4
Armchairs, swivel chairs and pouffes	5
Profim MICKEY	7
Profim TRILLO PRO	8
Visitor chairs	9
Profim ANA	11
Profim ARIZ	13
Profim BIT	16
Profim COM	19
Profim NOOR 4-LEG	26
Profim NOOR SLEDGEBASE	28
Profim NOOR FOOTBASE	30
Profim NOOR WOODEN LEGS	32
Profim NOOR UP	34
Profim NORMO	36
Profim ZOO	38
Sofas, armchairs, modular systems	41
Profim CHIC	43
Profim CHIC LOUNGE	45
Profim ELLIE PRO	47
Profim FAN	50
Profim MYTURN SOFA	53
Profim MYTURN TABLE	55
Profim NU	56
Profim OCTOBER	58
Profim OCTOBER TABLE	60
Profim REVO	61
Profim SNAP	64
Profim SOFTBOX	66
Profim SORRISO	72
Profim VANCOUVER LITE	73
Profim VANCOUVER OTO	79
Profim WALL IN	81
Tables, coat stands and accessories	86
Profim ALLROUND	88
Profim CHIC COFFEE TABLE	92
Profim CHIC RESTAURANT TABLE	94

Profim EMINENT	97
Profim Eminent - suspension bracket system	100
Profim REVO TABLES	101
Profim STANDARD FOLDING TABLE	104
Profim TABLES	108
Profim U-CONNECT	110
Profim SEVEN	113
Profim CUSHION	114
Technical details	115
Technical details	122
Fabrics and finishings	179
Profim Standard fabrics	180
Fabrics and finishings - Extended	195
Legend	199

ORDER ENTRY SPECIFICATIONS

When placing your order please remember to specify the following information:

- Product model code/name
- Number of products
- Fabric/leather and Colour Code
- Wooden, stain surface, plastic and table top colour/type
- Colour/paint on foot base/frame for chairs and tables
- Type of castors or glides
- Options. Eg. armrests, linking device
- Desired delivery date
- Delivery address

Binding sales agreement for the ordered products is concluded by formal order confirmation sent by Flokk.

Flokk sales conditions override any individual customer's general terms & conditions or regulations.

PRICES

All prices in DKK exclusive of VAT. Valid from 01/03/2025 Any typographical errors shall not be binding for Flokk and will be subject to correction without liability to the vendor.

CONDITIONS OF DELIVERY

Ex Works (Incoterms 2020), including packaging. A 3% transportation & energy cost surcharge on the net order value will be applied to all orders with delivery terms agreed different from Ex works.

Shipping fee of 5% of the net order value (min. DKK 250) is added on all orders, which is not delivered to addresses used or owned by the distributor.

Visible transport damage and discrepancies in the number of items received must always be noted on the bill of carriage at the time of receipt and reported to the carrier and Customer Service, Flokk A/S within 7 calendar days after receipt of the goods. Invisible damage (means no damaged packaging) must be reported in writing to Customer Service, Flokk A/S within 7 calendar days after receipt. If there are any problems with registration of the claim, please write to Customer Service Flokk immediate when the problems occur. Documentation must follow the e-mail.

For claims and transport damage you need to take photos and document the damage, before reporting in writing to Customer Service, Flokk.

Please document:

- Photo of Flokk product label (including order no.)
- Photo of damaged product goods
- Photo of damaged packaging (transport)
- Copy of transport document (if provided) or invoice
- Short description of claim

We encourage you to ensure recycling of all packaging material. Please sort and return the packaging material, using your local recycling partners/stations and follow your local regulations.

CHANGE/CANCELLATION OF ORDERS

Change/cancellation of orders on chairs or upholstery are possible up until production has begun.

Changes made 2 days after receiving the order confirmation, each amended or cancelled order will incur a charge per order (see below). Once production has started orders cannot be changed.

Each amended or cancelled order will incur a charge:

- Amended order (all changes & cancellations) before production start will incur a charge of 500 DKK per order
- Amended order & cancellations after purchasing has started will incur a charge of 750 DKK per order + cost of materials

For further information regarding change/cancellation of orders, please feel free to contact Customer Service, Flokk A/S.

NON-STANDARD PRODUCTS

Non-standard products not available in this pricelist could be proceed with quantities starting from 5 pcs and will be priced individually.

Fabrics and leathers that are not tested on our products, need to have an upholstery test before we can approve it and the order can be registered. Cost (DKK 1.545) for testing will be charged. Please contact Customer Service, Flokk A/S.

	Standard production time*	Non standard production time*
Product	standard: 10-20 working days	extended: 30 working days
Task chairs	10-20 working days	-
Visitor chairs	10-20 working days	exceptions: Com (plywood shells), Acos ^{Pro} ; MyTurn, Normo - 20-30 working days. Extended colours for Noor and Ana: 20-30 working days.
Soft seating	10-20 working days	-
Tables & Coat hangers	20-30 working days	-
special colors of frames	40 working days	-

* Transport days to be added.

Longer delivery times may occur periodically, during holidays and for especially large orders.

Armchairs

Swivel chairs

Pouffes

Profim MICKEY

ITO Design

- It is a unique combination of a pouffe and a swivel stool with height adjustment
- Totally intuitive and easy to use
- Provides support by tilting from side to side (range of 10 degrees in each direction)
- Two colours of plastic parts
- Möbelfakta certificate - a guarantee of durability, safety, environmental care and social responsibility during the production process

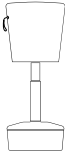
Item no	Base model +	Price Group (PG)	Price Group						Price
			0	①	②	③	④	⑤	
MMC0000000	Profim MICKEY • stool, swivel with height adjustment and sideways tilt 10° • base: Telegrey RAL 7047, Traffic gray RAL 7043 • column : Telegrey RAL 7047, Traffic gray RAL 7043, MetallicPro, White RAL 9016, Deep Green RAL 6004, Navy Blue RAL 5003, Burgundy RAL 3005, Salvia/Green RAL 6021, Blue RAL 5014, Terracota RAL 3012, Lightgrey, Grey		2 749	2 863	3 152	3 295	3 438	4 009	4 377

0 price group: Evo

1 price group: Cura, Tonal, Xtreme

2 price group: Select

3 price group: Capture, Oceanic, Step, Synergy

4 price group: Steelcut 3, Steelcut Trio 3

Base: Telegrey RAL 7047, Traffic gray RAL 7043 - when ordering please clearly indicate the chosen option.

Glides:

- teflon glides - universal (set).

When ordering please clearly indicate the chosen option.

The sides of the base can be made of:

- the same fabric as the seat,

- plastic in the same colour as the rest of plastic elements.

Please clearly indicate on your order the chosen option.

Handle for height adjustment is always made of the same fabric as the rest of the seat.



Plastic elements and the cover of the gas lift are made of different materials therefore their colour might vary slightly.



Profim TRILLO PRO

ITO Design

- Easily adjustable basic functions.
- Synchro self mechanism ensures adjustment to user's weight
- Several versions to choose from: backrest in plastic or with upholstered pad, plastics in two colours,
- Blue Angel certificate - confirms that our chair is environmentally friendly

Item no	Base model +	Price Group (PG)	0	①	②	③	④	⑤	Price
MSX200HS00	Profim TRILLO PRO 20HST <ul style="list-style-type: none"> • plastic backrest • self mechanism • 4-star base, high • base: black / white / graphite / polished aluminum / MetallicPro 		2 528	2 700	2 795	2 795	3 069	3 243	
MSX210HS00	Profim TRILLO PRO 21HST <ul style="list-style-type: none"> • plastic backrest with upholstered pad • self mechanism • 4-star base, high • base: black / white / graphite / polished aluminum / MetallicPro 		2 865	3 125	3 290	3 290	3 824	3 817	

0 price group: Evo

1 price group: Cura, Tonal, Xtreme

2 price group: Select

3 price group: Capture, Oceanic, Step, Synergy

4 price group: Steelcut 3, Steelcut Trio 3

Castors/glides:

- hard castors - for soft floors (set),
- soft castors - for hard floors (set),

Plastic colours:- black, grey (RAL 7043), light grey (RAL 7047).

Plastic elements: backrest and armrests.

In models 20HST / 21HST:

- base colour black / MetallicPro - plastic elements black, castors black,
- base colour white - plastic elements lightgrey (RAL 7047), castors lightgrey,
- base colour graphite - plastic elements black or grey (RAL 7043), castors black,
- base colour polished aluminium - plastic elements black, grey (RAL 7043) and castors black or plastic elements light grey (RAL 7047) and castors lightgrey.

Please clearly indicate on your order the chosen option.



www.blauer-engel.de/uz117

Visitor chairs

Profim ANA

Tias Eckhoff

- Polypropylene (PP) shell in various colours.

Item no	Base model +	Price Group (PG)	Price Group						Price	
			0	①	②	③	④	⑤		⑥
4340	Profim ANA 4340 • Without upholstery									685
4340s	Profim ANA 4340s • Upholstered seat		1 083	1 112	1 141	1 241	1 308	1 423	1 822	
4340sr	Profim ANA 4340sr • Upholstered seat and back		1 409	1 456	1 484	1 618	1 706	1 856	2 377	

Accessories/Options/Surcharges:

3YES	Linking device, welded. Must be specified at time of order. Can not be retrofitted.	107
PD303	Felt glides - 4 units.	64
149285	Chair trolley	3054
M400-1/2/3/4	Writing tablet in 12 mm beech or birch veneer, frame - only MetallicPro. Right/left	1029
RS091016	Plastic link, black, detachable	40

0 price group: Evo

1 price group: Cura, Tonal, Xtreme

2 price group: Select

3 price group: Capture, Oceanic, Step, Synergy

4 price group: Steelcut 3, Steelcut Trio 3

Frame of 19 x 1.5 mm tubular steel available in various colours.

Weight 3.7 kg model 4340.

Height: Seat 430 mm, Back 400 mm, Chair width 490 mm, Chair height 825 mm, Chair depth 515 mm.

Stackable up to 12 chairs without upholstery (height: 1.83 m), 10 chairs with seat upholstery (height: 1.65 m) and 7 chairs with seat and back upholstery.

Can be linked together using linking device - see options.

Table suspension Profim Ana. See Profim Eminent table.

Graphite shell colour in recycled PP.

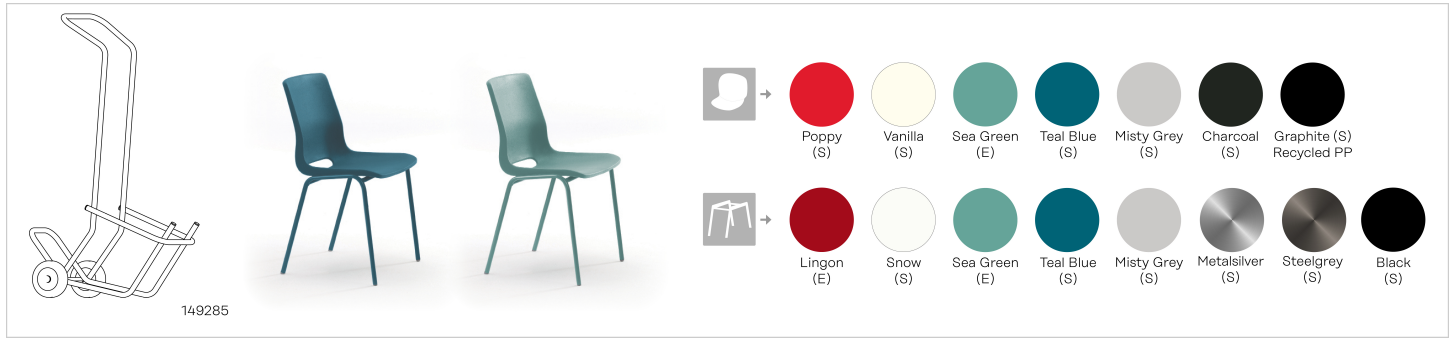

S=Standard Collection – normal delivery time from factory 10-15 working days. Applicable when all component options (fabric, shell, frame/legs) are standard(S).







E=Extended Collection – normal delivery time from factory 20-30 working days. Applicable when any or all component options selected are extended (E).



For larger orders, please contact Customer Service for delivery details.



Profim ARIZ

- Wide configuration possibilities with several plastic colours and a wide range of upholstery fabrics
- Plastic, upholstered, and mesh versions.
- Version with comfortable armrest available
- Possibility of high stacking (up to 45 pieces on a special trolley for chair transport)
- Option to join in rows, mount writing top and newspaper basket
- Möbelfakta certificate - a guarantee of durability, safety, environmental care and social responsibility during the production process

Item no	Base model +	Price Group (PG)	0	①	②	③	④	⑤	Price
MWE500V000	Profim ARIZ 550V • plastic seat and backrest • frame: black								1186
MWE550V000	Profim ARIZ 555V • plastic seat • mesh backrest • frame: black								1421
MWE600V000	Profim ARIZ 560V • upholstered seat • plastic backrest • frame: black		1343	1429	1507	1507	1704	1749	
MWE700V000	Profim ARIZ 570V • upholstered seat and backrest • frame: black		1595	1758	2011	2011	2615	2332	
MWE750V000	Profim ARIZ 575V • upholstered seat • mesh backrest • frame: black		1602	1704	1767	1767	1979	2049	
MWE500CV00	Profim ARIZ 550CV • bar stool • plastic seat and backrest • frame: black								1648

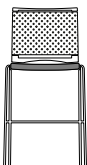
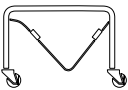
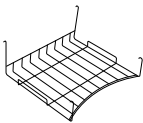
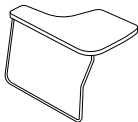
Item no	Base model +	Price Group (PG)	0	①	②	③	④	⑤	Price
MWE550CV00	Profim ARIZ 555CV • bar stool • plastic seat • mesh backrest • frame: black								1821
MWE600CV00	Profim ARIZ 560CV • bar stool • upholstered seat • plastic backrest • frame: black		1782	1892	1979	1979	2174	2296	
MWE700CV00	Profim ARIZ 570CV • bar stool • upholstered seat and backrest • frame: black		2033	2222	2474	2474	3077	2869	
MWE750CV00	Profim ARIZ 575CV • bar stool • upholstered seat • mesh backrest • frame: black		2042	2167	2230	2230	2442	2586	
MWE000W000	Profim ARIZ Chairs' trolley (W)								4150
MPDWEKO000	Profim ARIZ Newspapers bin (K)								309
MPDWEBL000	Profim ARIZ Table top (B)								959

Accessories/Options/Surcharges:

7COPR002	Frames colours: MetallicPro, White RAL 9016, Deep Green RAL 6004, Navy Blue RAL 5003, Burgundy RAL 3005, Salvia/Green RAL 6021, Blue RAL 5014, Terracota RAL 3012 (Only for: 550CV, 550V, 555CV, 555V, 560CV, 560V, 570CV, 570V, 575CV, 575V)	25
7COPR003	Frames colours: Lightgrey; Grey (Only for: 550CV, 550V, 555CV, 555V, 560CV, 560V, 570CV, 570V, 575CV, 575V)	89
7ARMR001	Armrests - metal, polypropylene pad (set) (Only for: 550V, 555V, 560V, 570V, 575V)	544

0 price group: Evo

1 price group: Cura, Tonal, Xtreme

2 price group: Select

3 price group: Capture, Oceanic, Step, Synergy

4 price group: Steelcut 3, Steelcut Trio 3

Glides:

- standard - teflon glides (universal),
- option - felt glides (for hard floors).

When ordering please clearly indicate the chosen option.

Colours of plastics:

black (CODE 01), white (CODE 20), gray blue (CODE 503), olive green (CODE 513), red (CODE 3020), navy (CODE 516), ashen (CODE 517).

In models Ariz 555/575 backrest frame only in colours: black, white and ashen.

Available versions with mesh backrest (in Ariz 555 model):

- black plastic seat (CODE 01) + black backrest frame (CODE 01) + black mesh,
- white plastic seat (CODE 20) + white backrest frame (CODE 20) + black mesh,
- ashen plastic seat (CODE 517) + ashen backrest frame (CODE 517) + black mesh.

In standard there is no option of different colours of backrest and seat.

Type of mesh: GZ.

Accessories only for 550V / 555V / 560V / 570V / 575V models:

- Chairs' trolley - frame colour is always black.
- Table top (B) - assembled on the left or right hand, available in chairs without armrests only, table top's frame colour is always chrome.
- Newspapers bin (K) - mounted under the seat, colour is always chrome.



Profim BIT

- Cantilever- or leg-mounted version
- Stackable
- Option to join in rows
- Choice of plastic or upholstered seat and plastic, mesh or upholstered backrest

Item no	Base model +	Price Group (PG)	0	①	②	③	④	⑤	Price
MBT500H000	Profim BIT 550H • 4-legged • plastic seat and backrest • frame: black								1186
MBT500V000	Profim BIT 550V • cantilever • plastic seat and backrest • frame: black								1507
MBT550H000	Profim BIT 555H • 4-legged • plastic seat • mesh backrest • frame: black								1461
MBT550V000	Profim BIT 555V • cantilever • plastic seat • mesh backrest • frame: black								1736
MBT600H000	Profim BIT 560H • 4-legged • seat upholstered pad • plastic backrest • frame: black		1436	1641	1814	1814	2026	2104	
MBT600V000	Profim BIT 560V • cantilever • seat upholstered pad • plastic backrest • frame: black		1751	1923	2136	2136	2331	2478	

Item no	Base model +	Price Group (PG)	0	①	②	③	④	⑤	Price
MBT700H000	Profim BIT 570H • 4-legged • seat and backrest • upholstered pads • frame: black		1 626	1 877	2 277	2 277	2 685	2 641	
MBT700V000	Profim BIT 570V • cantilever • seat and backrest • upholstered pads • frame: black		1 915	2 198	2 575	2 575	2 991	2 987	
MBT750H000	Profim BIT 575H • 4-legged • seat upholstered pad • mesh backrest • frame: black		1 696	1 877	2 065	2 148	2 285	2 395	
MBT750V000	Profim BIT 575V • cantilever • seat upholstered pad • mesh backrest • frame: black		2 002	2 190	2 371	2 466	2 575	2 751	
MBT800H000	Profim BIT 580H • 4-legged • seat and backrest fully upholstered • frame: black		1 626	2 253	3 101	3 226	3 651	3 597	
MBT800V000	Profim BIT 580V • cantilever • seat and backrest fully upholstered • frame: black		1 915	2 559	3 407	3 543	3 957	3 951	
Accessories/Options/Surcharges:									
7COPR002	Frames colours: MetallicPro, White RAL 9016, Deep Green RAL 6004, Navy Blue RAL 5003, Burgundy RAL 3005, Salvia/Green RAL 6021, Blue RAL 5014, Terracota RAL 3012								26
7COPR003	Frames colours: Lightgrey; Grey								159
7ARMR001	Armrests - plastic, always black (set)								252
7SEQU001	Quilting - pad or front side of the seat (Q1) (Only for: MBT600H000, 560V, 570H, 570V, 575H, 575V)								333
7BAQU001	Quilting - pad or front of the backrest (Q2) (Only for: 570H, 570V)								276

0 price group: Evo

1 price group: Cura, Tonal, Xtreme

2 price group: Select

3 price group: Capture, Oceanic, Step, Synergy

4 price group: Steelcut 3, Steelcut Trio 3

Glides:

- standard - teflon glides (universal),

- option - felt glides (for hard floors).

When ordering please clearly indicate the chosen option.

Plastic of backrest and seat - always black.

Backrest mesh - always black.

Types of mesh: Runner.







Quilting - extra charge to all price groups, lead time 30-40 working days.







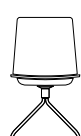



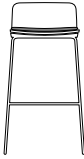

Profim COM

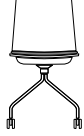
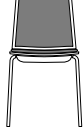



Paul Brooks

- Five types of bases allow any configuration
- The collection is completed with a barstool on a metal wire frame
- The square shape of the shell has four finishing options: plywood, with upholstered seat pad, with seat and backrest pad or fully upholstered
- The shell can come in different finishes: lacquered plywood, lined with natural veneer or HPL laminate which is scratch resistant

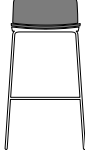
Item no	Base model +	Price Group (PG)	Price Group						Price
			0	①	②	③	④	⑤	
MCM120H000	Profim COM K12H <ul style="list-style-type: none"> • 4-legged • frame: black • plywood shell 								1066
MCM120V000	Profim COM K12V <ul style="list-style-type: none"> • cantilever • wire frame • frame: black • stackable • plywood shell 								1149
MCM120CV00	Profim COM K12CV <ul style="list-style-type: none"> • barstool • frame: black • plywood shell 								1605
MCM120HF00	Profim COM K12HF <ul style="list-style-type: none"> • "spider" frame • frame: black • plywood shell 								2167
MCM120HS00	Profim COM K12HS <ul style="list-style-type: none"> • "spider" frame • frame: black • swivel • plywood shell 								2413
MCM120HC00	Profim COM K12HC <ul style="list-style-type: none"> • "spider" frame • frame: black • on castors • plywood shell 								2451

Item no	Base model +	Price Group (PG)	Price Group						Price
			0	①	②	③	④	⑤	
MCM220H000	Profim COM K22H <ul style="list-style-type: none"> • 4-legged • frame: black • plywood shell • seat upholstered pad 		1343	1398	1538	1607	1677	1957	2095
MCM220V000	Profim COM K22V <ul style="list-style-type: none"> • cantilever • wire fame • frame: black • stackable • plywood shell • seat upholstered pad 		1421	1480	1630	1703	1776	2075	2221
MCM220CV00	Profim COM K22CV <ul style="list-style-type: none"> • barstool • frame: black • plywood shell • seat upholstered pad 		1860	1939	2130	2229	2325	2713	2906
MCM220HF00	Profim COM K22HF <ul style="list-style-type: none"> • "spider" frame • frame: black • plywood shell • seat upholstered pad 		2415	2515	2767	2893	3021	3522	3773
MCM220HS00	Profim COM K22HS <ul style="list-style-type: none"> • "spider" frame • frame: black • swivel • seat upholstered pad 		2651	2762	3012	3138	3264	3768	4019
MCM220HC00	Profim COM K22HC <ul style="list-style-type: none"> • "spider" frame • frame: black • on castors • seat upholstered pad 		2688	2799	3051	3177	3304	3805	4057
MCM320H000	Profim COM K32H <ul style="list-style-type: none"> • 4-legged • frame: black • plywood shell • seat and backrest upholstered pads 		1686	1756	1935	2021	2110	2462	2637

Item no	Base model +	Price Group (PG)	Price Group						Price
			0	①	②	③	④	⑤	
MCM320V000	Profim COM K32V <ul style="list-style-type: none"> • cantilever • wire frame • frame: black • stackable • plywood shell • seat and backrest upholstered pads 		1768	1841	2024	2116	2209	2577	2759
MCM320HF00	Profim COM K32HF <ul style="list-style-type: none"> • "spider" frame • frame: black • plywood shell • seat and backrest upholstered pads 		2762	2878	3165	3309	3453	4029	4316
MCM320HS00	Profim COM K32HS <ul style="list-style-type: none"> • "spider" frame • frame: black • swivel • seat and backrest upholstered pads 		2998	3123	3410	3554	3698	4273	4561
MCM320HC00	Profim COM K32HC <ul style="list-style-type: none"> • "spider" frame • frame: black • on castors • seat and backrest upholstered pads 		3034	3161	3448	3593	3736	4312	4599
MCM420H000	Profim COM K42H <ul style="list-style-type: none"> • 4-legged • frame: black • fully upholstered 		1513	1576	1736	1814	1894	2209	2366
MCM420V000	Profim COM K42V <ul style="list-style-type: none"> • cantilever • wire frame • frame: black • stackable • fully upholstered 		1595	1662	1827	1910	1992	2325	2493
MCM420CV00	Profim COM K42CV <ul style="list-style-type: none"> • barstool • frame: black • fully upholstered 		1980	2062	2270	2370	2475	2887	3093

Item no	Base model +	Price Group (PG)	Price Group						Price
			0	①	②	③	④	⑤	
MCM420HF00	Profim COM K42HF • "spider" frame • frame: black • fully upholstered		2 588	2 696	2 966	3 101	3 236	3 774	4 045
MCM420HS00	Profim COM K42HS • "spider" frame • frame: black • swivel • fully upholstered		2 824	2 941	3 211	3 346	3 480	4 020	4 289
MCM420HC00	Profim COM K42HC • "spider" frame • frame: black • on castors • fully upholstered		2 860	2 980	3 249	3 384	3 520	4 058	4 328
MCM000CTH0	Profim COM CTH • Trolley for transportation								1 566
Accessories/Options/Surcharges:									
7TFRA018	Frame: V1 - cantilever with metal frame (Only for: K12V, K22V, K32V, K42V)								406
7TFRA019	Frame: V2 - reversed cantilever (Only for: K12V, K22V, K32V, K42V)								89
7COPR002	Frames colours: MetallicPro, White RAL 9016, Deep Green RAL 6004, Navy Blue RAL 5003, Burgundy RAL 3005, Salvia/Green RAL 6021, Blue RAL 5014, Terracota RAL 3012 (Only for: K12CV, K12H, K12HC, K12HF, K12HS, K12V, K22CV, K22H, K22HC, K22HF, K22HS, K22V, K32H, K32HC, K32HF, K32HS, K32V, K42CV, K42H, K42HC, K42HF, K42HS, K42V)								33
7COPR003	Frames colours: Lightgrey; Grey , Metalsilver, Steelgray (Only for: K12CV, K12H, K12HC, K12HF, K12HS, K12V, K22CV, K22H, K22HC, K22HF, K22HS, K22V, K32H, K32HC, K32HF, K32HS, K32V, K42CV, K42H, K42HC, K42HF, K42HS, K42V)								148
7COPR006	Frame colour: Gold (Only for: K12HC, K12HF, K12HS, K22HC, K22HF, K22HS, K32HC, K32HF, K32HS, K42HC, K42HF, K42HS)								363
7ARMR001	Armrests (Only for: K12H, K12V, K22CV, K22H, K22V, K32H, K32V, K42H, K42V)								401
7TARM003	Plywood pad for armrest (Only for: K12H, K12V, K22H, K22V, K32H, K32V, K42H, K42V)								194
	HPL LW01 (white), LW02 (black), LW03 (light gray)LW04 (grey), LW06 (dark blue), LW07 (light burgundy)(grey) (Only for: K12CV, K12H, K12HC, K12HF, K12HS, K12V, K22CV, K22H, K22HC, K22HF, K22HS, K22V, K32H, K32HC, K32HF, K32HS, K32V)								561
	Natural veneers Ash (NA), Beech (NB), Oak (NO), Walnut (NW) (Only for: K12CV, K12H, K12HC, K12HF, K12HS, K12V, K22CV, K22H, K22HC, K22HF, K22HS, K22V, K32H, K32HC, K32HF, K32HS, K32V)								365
	Natural colored veneers (ash): White (CNA01), Black (CNA02), Dark green (CNA05), Navy blue (CNA06), Burgundy (CNA07) (Only for: K12CV, K12H, K12HC, K12HF, K12HS, K12V, K22CV, K22H, K22HC, K22HF, K22HS, K22V, K32H, K32HC, K32HF, K32HS, K32V)								365

Accessories/Options/Surcharges:

7SEQU001	Quilting - pad or front side of the seat (Q1) (Only for: K22CV, K22H, K22HC, K22HF, K22HS, K22V, K32H, K32HC, K32HF, K32HS, K32V)	261
7BAQU001	Quilting - pad or front of the backrest (Q2) (Only for: K32H, K32HC, K32HF, K32HS, K32V)	261
7SHQU004	Quilting - front side of the shell (Q3) (Only for: K42CV, K42H, K42HC, K42HF, K42HS, K42V)	580
7JIRO001	Possibility of joining in rows (Only for: K12H, K12V, K22H, K22V, K32H, K32V, K42H, K42V)	216
7TATO002	Table top 2PB - extra charge: version with armrests (Only for: K12H, K22H, K32H, K42H)	788
7HAND002	Shell with cut-out (C) in upper part of the backrest, enabling moving the chair (Only for: K12H, K12HC, K12HF, K12HS, K12V, K22H, K22HC, K22HF, K22HS, K22V, K32H, K32HC, K32HF, K32HS, K32V)	33

0 price group: Evo

1 price group: Cura, Tonal, Xtreme

2 price group: Select

3 price group: Capture, Oceanic, Step, Synergy

4 price group: Steelcut 3, Steelcut Trio 3

6 price group: Paloma

Colours of plywood - standard colours of lacquer: H6, H12, H5

Natural veneers -Ash (NA), Beech (NB), Oak (NO), Wallnut (NW)

Coloured natural veneers - White Ash CNA01, Black Ash CNA02, Deep Green Ash CNA05 (RAL 6004), Navy Blue Ash CNA06 RAL 5003, Burgundy Ash CNA07 RAL 3005

HPL - White LW01 (RAL 9016), Light Grey LW03 (NCS S 2500-N), Grey LW04 (RAL 7037), Black LW02 (RAL 9011), Navy Blue LW06 (RAL 5003), Light Burgundy LW07 (RAL 3004)

Glides:

- standard - teflon glides (universal),

- option - felt glides (for hard floors).

When ordering please clearly indicate the chosen option.

Armrest pad: Version V1 - plastic pad, always black.

Version Com K12 / K22 / K32 colour and type of plywood pad is always the same as shell.

Versions Com K4 (fully upholstered) armrest plywood pad finishing:

- Colours of plywood - standard colours of lacquer: H6, H12, H5

- Natural veneers -Ash (NA), Beech (NB), Oak (NO), Wallnut (NW)

- Coloured natural veneers - White Ash CNA01, Black Ash CNA02, Deep Green Ash CNA05 (RAL 6004), Navy Blue Ash CNA06 RAL 5003, Burgundy Ash CNA07 RAL 3005

- HPL - White LW01 (RAL 9016), Light Grey LW03 (NCS S 2500-N), Grey LW04 (RAL 7037), Black LW02 (RAL 9011), Navy Blue LW06 (RAL 5003), Light Burgundy LW07 (RAL 3004)

Please clearly indicate the chosen option.

Armrests:

- 2P - metal, polypropylene pad (set) - does not apply to versions V and V2,

- 2P - metal, plywood pad (set) - does not apply to versions V , V1 and V2.

Quilting - extra charge to all price groups, lead time 30-40 working days.



Frame version: V2



Frame version: V1



Com

Paul Brooks

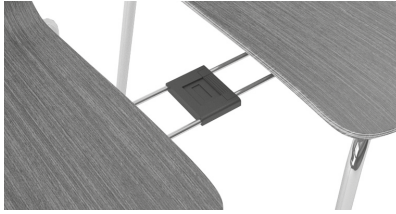

Joining in rows (H/V)

The linking part is an integral part of the chair, therefore it cannot be purchased and assembled at a later stage. The linking part is suitable for versions: H / H 2P / H 2PB / V.

Linking part is made of stainless steel and black plastic.

The total width of two connected chairs is:

- version H - 1160 mm,
- version H 2P/ H2PB - 1240-1310 mm,
- version V - 1170 mm.



Joining in rows (V1/V2)

The linking part is suitable for versions: V1 / V1 2P / V2. Always in black.

Total width of two connected chairs:

- version V1 - 985-1075 mm,
- version V1 2P - 1150-1220 mm,
- version V2 - 1165-1245 mm.



Trolley for transportation (CTH)

Trolley with a handle.

Available colours: black, metallic.

Always with soft castors.

Dimension: 1000 x 1010 x 630 mm



"Anti-panic" system (APA)*

"Anti-panic" connectors for chairs without armrests (refers only to the H versions).

Always in black.

Total width of two connected chairs: 1030 mm.



"Anti-panic" system (APB)*

"Anti-panic" connectors for chairs with armrests/ armrests with table top (refers only to the H versions).

Always in black.

Total width of two connected chairs: 1220-1290 mm.



"Anti-panic" system (APD)*

"Anti-panic" system for connecting rows (refers only to the H versions).

The price is for 1 connector.

Always in black.



Shell with cut-out (C)

Shell with cut-out in upper part of the backrest, enabling moving the chair. Do not concern versions with shell fully upholstered.



Table top (2PB)

The table top is an integral part of 2PB models therefore it cannot be purchased separately.







It is assembled on the right side of the chair and is equipped with anti-panic system which prevents blocking the table top in case of sudden movement. It's always black composite.

Maximum table load: 15kg.

Profim NOOR 4-LEG

StokkeAustad, Form Us With Love, Susanne Grønlund Design and Flokk design team

- Armrests available in matching colours to frame
- Stackable up to 10 chairs, 5 chairs with armrests (upholstered and unupholstered models)
- Table suspension for Profim Noor 6050/55 to Profim Eminent frame table available (See Eminent table)
- Red Dot Design award 2013
- Norwegian Design Council – Award for Design Excellence

Item no	Base model +	Price Group (PG)	Price Group						Price	
			0	①	②	③	④	⑤		⑥
6050	Profim NOOR 6050 • Polypropylene chair									1530
6055	Profim NOOR 6055 • 3D veneer chair • Oak									5356
6050s	Profim NOOR 6050S • Polypropylene chair • Seat upholstery		1712	1763	1803	1890	1945	2194	2482	
6050sb	Profim NOOR 6050sb • Polypropylene chair • Seat + back upholstery		1973	2034	2077	2181	2241	2533	2865	
6050f	Profim NOOR 6050f • Polypropylene chair • Fully upholstered in selected fabrics. See below Accessories/options for complete list		2374	2452	2500	2627	2699	3052		
6055s	Profim NOOR 6055s • 3D veneer chair • Oak • Seat upholstery		5347	5516	5629	5909	6077	6867	7764	

Item no	Base model +	Price Group (PG)	Price Group						Price
			0	①	②	③	④	⑤	
6055sb	Profim NOOR 6055sb • 3D veneer chair • Oak • Seat + back upholstery		5 609	5 787	5 903	6 201	6 375	7 202	8 145

Accessories/Options/Surcharges:

3YES	Linking device, welded. Must be specified at time of order. Can not be retrofitted.	83
PD303	Felt glides - 4 units.	68
AR809	Noor armrests pair	717
SH30006	Additional price* for dark stained oak 3D veneer shell (Only for: 6055, 6055s, 6055sb)	339
149285	Chair trolley	3054

0 price group: Evo*

1 price group: Cura, Tonal, Xtreme

2 price group: Select

3 price group: Capture, Oceanic, Step, Synergy

4 price group: Steelcut 3, Steelcut Trio 3

*not available for Noor 6050F

6-8 mm polypropylene (PP) and 6.7 mm 3D veneer shells (oak or dark stained oak*)

16x2 mm 4 leg tubular steel base

Weight: 5.7 kg model 6050, 4.7 kg model 6055

Seat height 439 mm, Back height 357 mm, Chair width 543 mm, Chair width w/armrests 550 mm, Chair height 835 mm, Chair depth 490 mm



S=Standard Collection – normal production time 10-15 working days. Applicable when all component options (fabric, shell, frame/legs) are standard (S).

E=Extended Collection – normal production time 20-30 working days. Applicable when any or all component options selected are extended (E).







For larger orders, please contact Customer Service for delivery details.



Profim NOOR SLEDGEBASE

StokkeAustad, Form Us With Love, Susanne Grønlund Design and Flokk design team

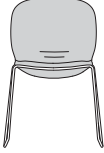
- Armrests available in matching colours to frame
- Stackable up to 10 chairs, 5 chairs with armrests (upholstered and unupholstered models)
- Table suspension for Profim Noor 6060/65 to Profim Eminent frame table available.
- Red Dot Design - 'Best of the best' award winner 2013
- Norwegian Design Council - Award for Design Excellence

Item no	Base model +	Price Group (PG)	Price Group						Price	
			0	①	②	③	④	⑤		⑥
6060	Profim NOOR 6060 • Polypropylene chair									1749
6065	Profim NOOR 6065 • 3D veneer chair • Oak									5575
6060s	Profim NOOR 6060s • Polypropylene chair • Seat upholstery		1917	1976	2018	2119	2180	2460	2784	
6060sb	Profim NOOR 6060sb • Polypropylene chair • Seat + back upholstery		2179	2249	2294	2411	2479	2799	3166	
6060f	Profim NOOR 6060f • Polypropylene chair • Fully upholstered in selected fabrics. See below Accessories/options for complete list		2589	2675	2725	2862	2944	3326		
6065s	Profim NOOR 6065s • 3D veneer chair • Oak • Seat upholstery		5553	5728	5846	6138	6313	7132	8066	

Item no	Base model +	Price Group (PG)	Price Group						Price
			0	①	②	③	④	⑤	
6065sb	Profim NOOR 6065sb • 3D veneer chair • Oak • Seat + back upholstery		5 817	6 000	6 123	6 427	6 612	7 467	8 448

Accessories/Options/Surcharges:

3YES	Linking device, welded. Must be specified at time of order. Can not be retrofitted.	83
PD303	Felt glides - 4 units.	69
AR809	Noor armrests pair	717
SH30006	Additional price* for dark stained oak 3D veneer shell (Only for: 6065, 6065s, 6065sb)	339
149285	Chair trolley	3054

0 price group: Evo*

1 price group: Cura, Tonal, Xtreme

2 price group: Select

3 price group: Capture, Oceanic, Step, Synergy

4 price group: Steelcut 3, Steelcut Trio 3

*not available for Noor 6060F

6-8 mm polypropylene (PP) and 6.7 mm 3D veneer shells (oak or dark stained oak*) 12 mm steel sledgebase Weight: 6.5 kg model 6060, 6.2 kg model 6065
Seat height 439 mm, Back height 357 mm, Chair width 557 mm, Chair height 835 mm, Chair depth 525 mm



S=Standard Collection – normal production time 10-15 working days. Applicable when all component options (fabric, shell, frame/legs) are standard (S).

E=Extended Collection – normal production time 20-30 working days. Applicable when any or all component options selected are extended (E).

For larger orders, please contact Customer Service for delivery details.



Profim NOOR FOOTBASE

StokkeAustad, Form Us With Love, Susanne Grønlund Design and Flokk design team

- Standard gaslift B black
- Seat mechanism and footbase (Ø665 mm) in black painted aluminium as standard.
- Polished aluminium seat mechanism and footbase available as option. Seat mechanism, gaslift and footbase in white lacquered aluminium available as option
- Armrest available in black, white or metal silver
- Table suspension for Profim Noor 6070/75 to Profim Eminent frame table available.
- Red Dot Design Award 2013
- Norwegian Design Council – Award for Design Excellence

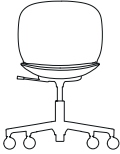
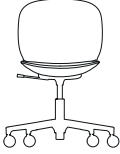
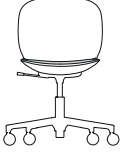
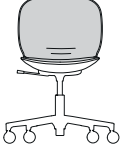
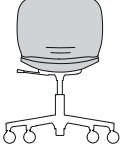
Item no	Base model +	Price Group (PG)	0	①	②	③	④	⑤	⑥	Price
6070	Profim NOOR 6070 • Polypropylene chair									2549
6075	Profim NOOR 6075 • 3D veneer chair • Oak									6375
6070s	Profim NOOR 6070s • Polypropylene chair • Seat upholstery		2 682	2 765	2 823	2 962	3 048	3 441	3 893	
6070sb	Profim NOOR 6070sb • Polypropylene chair • Seat + back upholstery		2 941	3 033	3 097	3 250	3 344	3 779	4 273	
6070f	Profim NOOR 6070f • Polypropylene chair • Fully upholstered in selected fabrics. See below Accessories/options for complete list		3 381	3 487	3 559	3 734	3 842	4 339		

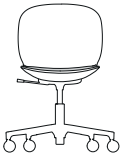
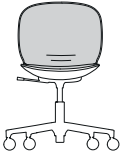
Item no	Base model +	Price Group (PG)	Price Group						Price
			0	①	②	③	④	⑤	
6075s	Profim NOOR 6075s • 3D veneer chair • Oak • Seat upholstery		6 314	6 513	6 647	6 978	7 180	8 112	9 175
6075sb	Profim NOOR 6075sb • 3D veneer chair • Oak • Seat + back upholstery		6 578	6 786	6 924	7 272	7 479	8 447	9 555

Accessories/Options/Surcharges:

125182	Glides, 58 mm	0
FB3004	Footbase in polished aluminium	530
FB3013	Footbase alu white 25"	440
AR809	Noor armrests pair	717
SH30006	Additional price* for dark stained oak 3D veneer shell (Only for: 6075, 6075s, 6075sb)	339

0 price group: Evo*

1 price group: Cura, Tonal, Xtreme

2 price group: Select

3 price group: Capture, Oceanic, Step, Synergy

4 price group: Steelcut 3, Steelcut Trio 3

*not available for Noor 6070F

6-8 mm polypropylene (PP) and 6.7 mm 3D veneer shells (oak or dark stained oak*)

Weight: 8.0 kg model 6070, 7.6 kg model 6075

Seat height 355-490 mm, back height 357 mm, chair width and depth 665 mm, chair height 727-857 mm



S=Standard Collection – normal production time 10-15 working days. Applicable when all component options (fabric, shell, frame/legs) are standard (S).

E=Extended Collection – normal production time 20-30 working days. Applicable when any or all component options selected are extended (E).







For larger orders, please contact Customer Service for delivery details.



Profim NOOR WOODEN LEGS

StokkeAustad, Form Us With Love, Susanne Grønlund Design and Flokk design team

- Seat frame in black painted aluminium as standard.
- Wooden legs: natural stained ash as standard.
- Not stackable
- Red Dot Design Award 2013
- Norwegian Design Council – Award for Design Excellence

Item no	Base model +	Price Group (PG)	Price Group						Price	
			0	①	②	③	④	⑤		⑥
6080	Profim NOOR 6080 • Polypropylene chair									3993
6085	Profim NOOR 6085 • 3D veneer chair • Oak									7820
6080s	Profim NOOR 6080s • Polypropylene chair • Seat upholstery		4 049	4 177	4 262	4 475	4 603	5 201	5 882	
6080sb	Profim NOOR 6080sb • Polypropylene chair • Seat + back upholstery		4 312	4 449	4 538	4 769	4 905	5 539	6 266	
6080f	Profim NOOR 6080f • Polypropylene chair • Fully upholstered in selected fabrics. See below Accessories/options for complete list		4 801	4 951	5 054	5 304	5 457	6 163		
6085s	Profim NOOR 6085s • 3D veneer chair • Oak • Seat upholstery		7 687	7 929	8 091	8 498	8 737	9 871	11 163	

Item no	Base model +	Price Group (PG)	Price Group						Price	
			0	①	②	③	④	⑤		⑥
6085sb	Profim NOOR 6085sb • 3D veneer chair • Oak • Seat + back upholstery		7 948	8 199	8 367	8 786	9 038	10 208	11 547	

Accessories/Options/Surcharges:

PD303	Felt glides - 4 units.	68
SH30006	Additional price* for dark stained oak 3D veneer shell (Only for: 6085, 6085s, 6085sb)	339
FC3008	Additional price for seat frame in polished aluminium	150

0 price group: Evo*

1 price group: Cura, Tonal, Xtreme

2 price group: Select

3 price group: Capture, Oceanic, Step, Synergy

4 price group: Steelcut 3, Steelcut Trio 3

*not available for Noor 6080F

6-8 mm polypropylene (PP) and 6.7 mm 3D veneer shells (oak or dark stained oak*)

Weight: 5.4 kg model 6080, 4.6 kg model 6085

Seat height 439 mm, Back height 357 mm, Chair width 490 mm, Chair height 832 mm, Chair depth 480 mm



S=Standard Collection – normal production time 10-15 working days. Applicable when all component options (fabric, shell, frame/legs) are standard (S).

E=Extended Collection – normal production time 20-30 working days. Applicable when any or all component options selected are extended (E).







For larger orders, please contact Customer Service for delivery details.



Profim NOOR UP

StokkeAustad, based on the design of the RBM Noor of StokkeAustad, Form Us With Love, Susanne Grønlund Design and Flokk design team

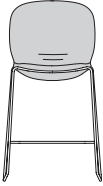
- Suitable for tables around 90 cm high
- Armrests available in matching colours to frame
- Stackable up to 5 chairs

Item no	Base model +	Price Group (PG)	Price Group						Price	
			0	①	②	③	④	⑤		⑥
6090	Profim NOOR UP 6090 • Polypropylene chair									2 384
6095	Profim NOOR UP 6095 • 3D veneer chair • Oak									6 213
6090s	Profim NOOR UP 6090s • Polypropylene chair • Seat upholstery		2 523	2 604	2 656	2 787	2 867	3 242	3 665	
6090sb	Profim NOOR UP 6090sb • Polypropylene chair • Seat + back upholstery		2 785	2 873	2 931	3 078	3 166	3 579	4 046	
6090f	Profim NOOR UP 6090f • Polypropylene chair • Fully upholstered in selected fabrics. See below Accessories/options for complete list		3 216	3 317	3 385	3 558	3 656	4 131		
6095s	Profim NOOR UP 6095s • 3D veneer chair • Oak • Seat upholstery		6 162	6 355	6 486	6 808	7 002	7 909	8 946	

Item no	Base model +	Price Group (PG)	Price Group						Price
			0	①	②	③	④	⑤	
6095sb	Profim NOOR UP 6095sb • 3D veneer chair • Oak • Seat + back upholstery		6 422	6 626	6 760	7 097	7 300	8 248	9 330

Accessories/Options/Surcharges:

PD303	Felt glides - 4 units.	69
SH30006	Additional price* for dark stained oak 3D veneer shell (Only for: 6095, 6095s, 6095sb)	339
4107	Noor armrests - pair	781

0 price group: Evo*

1 price group: Cura, Tonal, Xtreme

2 price group: Select

3 price group: Capture, Oceanic, Step, Synergy

4 price group: Steelcut 3, Steelcut Trio 3

*not available for Noor 6090F

6-8 mm polypropylene (PP) and 6.7 mm 3D veneer shells (oak or dark stained oak*)

Weight: 7.7 kg model 6090, 7.2 kg model 6095

12 mm medium-high steel sledgebase

Seat height 630 mm, Back height 357 mm, Chair width 565 mm, Chair height 1025 mm, Chair depth 548 mm



S=Standard Collection - normal production time 10-15 working days. Applicable when all component options (fabric, shell, frame/legs) are standard (S).

E=Extended Collection - normal production time 20-30 working days. Applicable when any or all component options selected are extended (E).



For larger orders, please contact Customer Service for delivery details.



Profim NORMO

Studio Ganszyniec

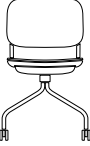
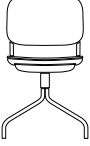
- Chair designed for work and meetings
 - Solid metal construction guarantees stability regardless of intensity of use
 - Our first circular product
 - Manufactured without the use of glue or staples for easy disassembly
 - The seat structure is created from 100% recycled plastic (PP)
 - Normo can be separated/disassembled and recycled up to 94%

Item no	Base model +	Price Group (PG)	Price Group						Price
			0	①	②	③	④	⑤	
MKN500H000	Profim NORMO 500H • 4 legged • seat and backrest upholstered		1704	1892	2167	2254	2520	2514	2904
MKN500HC00	Profim NORMO 500HC • spider' frame on castors • seat and backrest upholstered		2356	2536	2812	2924	3165	3261	3767
MKN500HS00	Profim NORMO 500HS • spider' frame on glides • swivel • seat and backrest upholstered		2528	2716	2991	3110	3329	3470	4008
MKN500V000	Profim NORMO 500V • cantilever • seat and backrest upholstered		1758	1947	2222	2310	2559	2577	2977

Accessories/Options/Surcharges:

7ARMR020	SP - metal armrests, short	259
7ARMR021	LP - metal armrests, long	309

0 price group: Evo

1 price group: Cura, Tonal, Xtreme

2 price group: Select

3 price group: Capture, Oceanic, Step, Synergy

4 price group: Steelcut 3, Steelcut Trio 3

Frames colours:

- Black RAL 9005
- MetallicPro
- White RAL 9016

- Lightgrey NCS S 2500-N
- Grey NCS S 6500-N
- Deep green RAL 6004
- Navy blue RAL 5003
- Burgundy RAL 3005
- Salvia/Green RAL 6021
- Blue RAL 5014
- Terracota RAL 3012

Glides:

- teflon glides (universal),
- felt glides (for hard floors).

Castors in HC model:

- universal.

When ordering please clearly indicate the chosen option.



Armrest SP





Armrest LP



Profim ZOO

Paul Brooks

- Variety of configurations
- Available in different versions: on four legs, legs with castors or on cantilever, with plastic or upholstered seat, plastic or upholstered backrest, with or without armrests
- Available in three plastic colours (black, grey and light grey) and five frame colours

Item no	Base model +	Price Group (PG)	0	①	②	③	④	⑤	Price
MZO522H000	Profim ZOO 522H • 4-legged • frame: black • plastic seat and backrest								1 429
MZO502H000	Profim ZOO 502H • 4-legged • frame: black • upholstered seat • plastic backrest		1 617	1 758	1 869	1 943	2 300	2 167	
MZO500H000	Profim ZOO 500H • 4-legged • frame: black • upholstered seat and backrest		2 315	2 615	2 921	3 038	3 603	3 388	

Accessories/Options/Surcharges:

7TFRA005	Frame HC - 4-legged version with castors	423
7CFRA051	Frame: MetallicPro	23
7COPR002	Frames colours: MetallicPro, White RAL 9016, Deep Green RAL 6004, Navy Blue RAL 5003, Burgundy RAL 3005, Salvia/Green RAL 6021, Blue RAL 5014, Terracota RAL 3012	26
7COPR003	Frames colours: Lightgrey; Grey	159
7CFRA010	Frame: grey / lightgrey	
7ARMR001	Armrests	317
7TATO002	Table top	580
7JIRO001	Possibility of joining in rows	227

0 price group: Evo

1 price group: Cura, Tonal, Xtreme

2 price group: Select

3 price group: Capture, Oceanic, Step, Synergy

4 price group: Steelcut 3, Steelcut Trio 3

Glides:

- standard - teflon glides (universal),
- option - felt glides (for hard floors).

Castors in HC models:

- universal castors

When ordering please clearly indicate the chosen option.

Plastic colours for seats, backrests and armrests:

black (RAL 9005), grey, lightgrey.

It is possible to freely join the colours of seat, backrest and armrests.

Although in one, the colour of individual elements of the chair such as seat, backrest, armrests and frame, can vary due to different types of materials used.

Seat cover always black (RAL 9005).

In model Zoo 500 without armrests the plastic elements connecting the frame with backrest are:

- black frame - always black (RAL 9005),
- MetallicPro frame - always grey,
- grey / lightgrey frame - always in frame colour.



Frame version: HC



Zoo

Paul Brooks

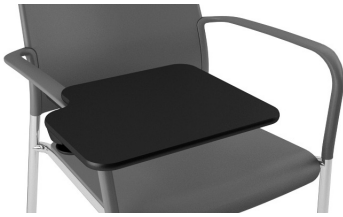
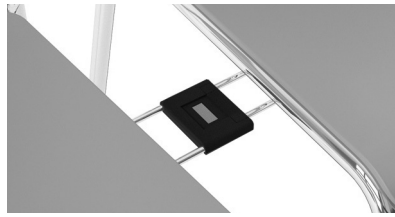

Table top (2PB)

The table top is an integral part of 2PB models therefore it cannot be purchased separately. It is assembled on the right side of the chair and is equipped with anti-panic system which prevents blocking the table top in case of sudden movement. It's always black composite. Maximum table load: 15 kg.



Joining in rows - 4-legged version

The linking part is an integral part of the chair, therefore it cannot be purchased and assembled at a later stage. The linking part is suitable for versions on 4 legs (H/H 2P/H 2PB). Linking part is made of stainless steel and black plastic. The total width of two connected chairs is:
- no armrests - 1070 mm,
- with armrests - 1260 mm.



„Anti-panic” system (APA)*

"Anti-panic" connectors for chairs without armrests. Available colours: black, metallic. Total width of two connected chairs: 1120 mm. The anti-panic system meets EN 14703 norm.



„Anti-panic” system (APB)*

"Anti-panic" connectors for chairs with armrests. Always in black. Total width of two connected chairs: 1170 mm. The anti-panic system meets EN 14703 norm.



„Anti-panic” system (APC)*

"Anti-panic" connectors for chairs with armrests and a table top. Always in black. Total width of two connected chairs: 1350 mm. The anti-panic system meets EN 14703 norm.



„Anti-panic” system (APD)*

"Anti-panic" system for connecting rows. The price is for 1 connector. Always in black. The anti-panic system meets EN 14703 norm.



Trolley for transportation (CTH)

Trolley with a handle. Available colours: black, metallic. Always with soft castors. Dimensions: 1000 x 1000 x 600 mm

Sofas







Armchairs

Modular systems

Profim CHIC

Christophe Pillet

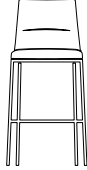
- The seat is equipped with the return memory (it returns to the starting position by itself)
- Restaurant and bar chairs with a range of bases and armchairs with a swivel base or with glides
- Möbelfakta certificate - a guarantee of durability, safety, environmental care and social responsibility during the production process

Item no	Base model +	Price Group (PG)	Price Group						Price
			0	①	②	③	④	⑤	
MCC210H000	Profim CHIC 21H <ul style="list-style-type: none"> • chair • metal legs • frame: MetallicPro; Black RAL 9005; White RAL 9016; Deep Green RAL 6004; Navy Blue RAL 5003; Burgundy RAL 3005; Salvia/Green RAL 6021, Blue RAL 5014; Terracota RAL 3012 • without armrests 		3 136	3 267	3 591	3 756	3 919	4 574	4 898
MCC200H000	Profim CHIC 20H <ul style="list-style-type: none"> • chair • metal legs • frame: MetallicPro; Black RAL 9005; White RAL 9016; Deep Green RAL 6004; Navy Blue RAL 5003; Burgundy RAL 3005; Salvia/Green RAL 6021, Blue RAL 5014; Terracota RAL 3012 • with armrests 		3 427	3 570	3 929	4 108	4 284	4 999	5 356
MCC200F000	Profim CHIC 20F <ul style="list-style-type: none"> • chair • base: polished aluminium • 4-star base 		3 946	4 111	4 522	4 728	4 933	5 756	6 165
MCC100FU00	Profim CHIC 10FU <ul style="list-style-type: none"> • armchair 		5 010	5 219	5 741	6 001	6 263	7 304	7 828
MCC210CH00	Profim CHIC 21CH <ul style="list-style-type: none"> • bar stool without armrests • metal legs • frame: MetallicPro; Black RAL 9005; White RAL 9016; Deep Green RAL 6004; Navy Blue RAL 5003; Burgundy RAL 3005; Salvia/Green RAL 6021, Blue RAL 5014; Terracota RAL 3012 		3 666	3 819	4 203	4 393	4 585	5 345	5 729
MCC200CH00	Profim CHIC 20CH <ul style="list-style-type: none"> • bar stool • metal legs • frame: MetallicPro; Black RAL 9005; White RAL 9016; Deep Green RAL 6004; Navy Blue RAL 5003; Burgundy RAL 3005; Salvia/Green RAL 6021, Blue RAL 5014; Terracota RAL 3012 		3 960	4 124	4 537	4 743	4 949	5 774	6 187

Accessories/Options/Surcharges:

7TFRA011	Frame: HW - wooden legs beech wood - H5, H6, H7, H8, H11, H12 (HW) (Only for: 20H, 21H)	2043
7TGAS003	Gas lift with memory (Only for: 20F)	561
7TFRA022	Gas lift with memory without height adjustment (Only for: 10FU)	1353
7COPR003	Frames colours: Lightgrey; Grey , Metalsilver, Steelgray (Only for: 20CH, 20H, 21CH, 21H)	148
7COPR006	Frame colour: Gold (Only for: 20H, 21H)	295

0 price group: Evo

1 price group: Cura, Tonal, Xtreme

2 price group: Select

3 price group: Capture, Oceanic, Step, Synergy

4 price group: Steelcut 3, Steelcut Trio 3

6 price group: Paloma

Glides:

- standard - teflon glides (universal),

- option - felt glides (for hard floors).

When ordering please clearly indicate the chosen option.







Frame version: HW

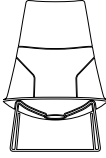
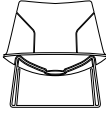
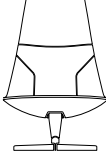

Profim CHIC LOUNGE

Christophe Pillet

- Characteristic detail in the form of vertical stitching
- Two backrest levels – for different needs and different users
- Possibility to combine leather and fabric in one cover
- Possibility to choose different upholstery colours
- Cushion and footrest increase the comfort of rest
- Attractive price/quality ratio
- Möbelfakta certificate - a guarantee of durability, safety, environmental care and social responsibility during the production process

Item no	Base model +	Price Group (PG)	①	②	③	④	⑤	⑥	Price
MCLA10V300	Profim CHIC LOUNGE A10V3 • armchair • high backrest • wire frame • frame: MetallicPro; Black RAL 9005; White RAL 9016; Deep Green RAL 6004; Navy Blue RAL 5003; Burgundy RAL 3005; Salvia/Green RAL 6021, Blue RAL 5014; Terracota RAL 3012		6 298	6 926	7 242	7 557	8 815	10 748	
MCLA20V300	Profim CHIC LOUNGE A20V3 • armchair • low backrest • wire frame • frame: MetallicPro; Black RAL 9005; White RAL 9016; Deep Green RAL 6004; Navy Blue RAL 5003; Burgundy RAL 3005; Salvia/Green RAL 6021, Blue RAL 5014; Terracota RAL 3012		5 660	6 226	6 509	6 792	7 924	9 343	
MCLA10F000	Profim CHIC LOUNGE A10F • armchair • high backrest • 4-star base • frame: MetallicPro; Black RAL 9005; White RAL 9016; Deep Green RAL 6004; Navy Blue RAL 5003; Burgundy RAL 3005; Salvia/Green RAL 6021, Blue RAL 5014; Terracota RAL 3012		8 124	8 936	9 342	9 750	11 373	12 719	
MCLA20F000	Profim CHIC LOUNGE A20F • armchair • low backrest • 4-star base • frame: MetallicPro; Black RAL 9005; White RAL 9016; Deep Green RAL 6004; Navy Blue RAL 5003; Burgundy RAL 3005; Salvia/Green RAL 6021, Blue RAL 5014; Terracota RAL 3012		7 487	8 235	8 610	8 983	10 483	11 275	
MCLPV30000	Profim CHIC LOUNGE PV3 • footrest • wire frame • frame: MetallicPro; Black RAL 9005; White RAL 9016; Deep Green RAL 6004; Navy Blue RAL 5003; Burgundy RAL 3005; Salvia/Green RAL 6021, Blue RAL 5014; Terracota RAL 3012		3 446	3 790	3 965	4 136	4 823	5 599	
MCLCU00000	Profim CHIC LOUNGE CU • high backrest cushion		583	640	668	698	813	1 178	

Accessories/Options/Surcharges:

7COPR003	Frames colours: Lightgrey; Grey , Metalsilver, Steelgray (Only for: A10F, A10V3, A20F, A20V3, PV3)	148
7COPR006	Frame colour: Gold (Only for: A10F, A20F)	511
7COPR006	Frame colour: Gold (Only for: A10V3, A20V3, PV3)	363

1 price group: Cura, Tonal, Xtreme

2 price group: Select

3 price group: Capture, Oceanic, Step, Synergy

4 price group: Steelcut 3, Steelcut Trio 3

6 price group: Paloma

Glides:

- standard - teflon glides (universal),

- option - felt glides (for hard floors).

When ordering please clearly indicate the chosen option.

Option of mixing colours of the same fabric according to below scheme:

A - inner part of shell colour, B - outer part of shell colour.

In case of order of such option, following example should be specified: SC-67097/SC-60132 (where SC-67097 - A, SC-60132 - B).

Option is available at no extra charge.





In models A10V3/A10F it is possible to order extra cushion for the backrest.





Profim ELLIE PRO

ITO Design

- Quick and easy adjustment with the synchro self mechanism (height and tilt adjustment).
- Mechanism fully integrated into the seat
- Possibility of choosing two-colour upholstery
- Several types and colours of bases (four- and five-star bases and metal wire frame or version with wooden legs)
- Blue Angel certificate - confirms that our chair is environmentally friendly

Item no	Base model +	Price Group (PG)	0	①	②	③	④	⑤	Price
MHB100ST00	Profim ELLIE PRO 10ST • swivel armchair • Self mechanism • high backrest • 5-star base • base: black		5 345	5 902	6 840	7 114	9 280	10 329	
MHB200ST00	Profim ELLIE PRO 20ST swivel armchair Self mechanism low backrest 5-star base base: black		5 266	5 485	6 034	6 308	6 583	7 681	
MHB100HS00	Profim ELLIE PRO 10HST • swivel armchair • Self mechanism • high backrest • high 4-star base • base: MetallicPro; Black RAL 9005; White RAL 9016; Deep Green RAL 6004; Navy Blue RAL 5003; Burgundy RAL 3005; Salvia/Green RAL 6021, Blue RAL 5014; Terracota RAL 3012; polished aluminum		5 886	6 132	6 746	7 050	7 358	8 584	
MHB200HS00	Profim ELLIE PRO 20HST • swivel armchair • Self mechanism • low backrest • high 4-star base • base: MetallicPro; Black RAL 9005; White RAL 9016; Deep Green RAL 6004; Navy Blue RAL 5003; Burgundy RAL 3005; Salvia/Green RAL 6021, Blue RAL 5014; Terracota RAL 3012; polished aluminum		5 674	5 910	6 502	6 796	7 090	8 273	
MHB100V000	Profim ELLIE PRO 10V3 • swivel armchair • Self mechanism • high backrest • wire frame • frame: MetallicPro; Black RAL 9005; White RAL 9016; Deep Green RAL 6004; Navy Blue RAL 5003; Burgundy RAL 3005; Salvia/Green RAL 6021, Blue RAL 5014; Terracota RAL 3012		6 165	6 422	7 063	7 386	7 705	8 990	

Item no	Base model +	Price Group (PG)	0	①	②	③	④	⑤	Price
MHB200V000	Profim ELLIE PRO 20V3 <ul style="list-style-type: none"> • swivel armchair • Self mechanism • low backrest • wire frame • frame: MetallicPro; Black RAL 9005; White RAL 9016; Deep Green RAL 6004; Navy Blue RAL 5003; Burgundy RAL 3005; Salvia/Green RAL 6021, Blue RAL 5014; Terracota RAL 3012 		5 953	6 201	6 820	7 131	7 441	8 680	
MHB100HW00	Profim ELLIE PRO 10HW <ul style="list-style-type: none"> • swivel armchair • Self mechanism • high backrest • wooden legs • frame: beech wood - H5, H6, H12 		7 828	8 153	8 972	9 378	9 787	11 418	
MHB200HW00	Profim ELLIE PRO 20HW <ul style="list-style-type: none"> • swivel armchair • Self mechanism • low backrest • wooden legs • frame: beech wood - H5, H6, H12 		7 616	7 932	8 727	9 124	9 520	11 107	

Accessories/Options/Surcharges:

7BASC008	Light Gray (Only for: 10ST, 20ST)	80
7TARM006	Upholstered armpad - leather pad on the armrests	144
7COPR002	Frames colours: MetallicPro, White RAL 9016, Deep Green RAL 6004, Navy Blue RAL 5003, Burgundy RAL 3005, Salvia/Green RAL 6021, Blue RAL 5014, Terracota RAL 3012 (Only for: 10HST, MHB200HS00)	26
7COPR003	Frames colours: Lightgrey; Grey (Only for: 10HST, MHB200HS00)	159
7COPR003	Frames colours: Lightgrey; Grey (Only for: 10V3, 20V3)	148
7CFRA025	Frame : metalsilver (Only for: 10V3, 20V3)	171
7COPR006	Frame colour: Gold (Only for: 10V3, 20V3)	501

0 price group: Evo

1 price group: Cura, Tonal, Xtreme

2 price group: Select

3 price group: Capture, Oceanic, Step, Synergy

4 price group: Steelcut 3, Steelcut Trio 3

Castors / glides:

Standard:

- hard castors - for soft floors.

Option:

- soft castors - for hard floors,

- teflon glides – universal,

- felt glides - for hard floors.

When ordering please clearly indicate the chosen option.

In case of armrests with a leather pad, the threads will always be the same as the upholstery inside the shell.

In models HST, V3, HW Self mechanism is not height adjustable.

Option of mixing colours of the same fabric according to below scheme:

A - inner part of shell colour, B - outer part of shell colour.

In case of order of such option, following example should be specified: SC-67097/SC-60132 (where SC-67097 - A, SC-60132 - B). Option is available at no extra charge.









www.blauer-engel.de/uz117

Profim FAN

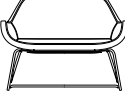
Piotr Kuchciński

- Several types of bases - glides and castors as well as wooden legs which perfectly match the SW40 and Revo tables
- Additional cushion improves comfort of use
- The collection also includes a cantilever sofa
- Two types of thread to choose from (upholstery colour or decorative thread)
- Möbelfakta certificate - a guarantee of durability, safety, environmental care and social responsibility during the production process

Item no	Base model +	Price Group (PG)	Price Group						Price
			0	①	②	③	④	⑤	
MFN100H000	Profim FAN 10H • armchair • 4-legged • frame: black		2 830	2 949	3 391	3 685	3 979	4 421	4 716
MFN100V000	Profim FAN 10V • armchair • cantilever • frame: black		3 017	3 141	3 614	3 927	4 243	4 713	5 026
MFN200V000	Profim FAN 20V • 2-seat sofa • cantilever • frame: black		4 122	4 774	5 669	5 895	7 576	6 587	8 934
MFN100R000	Profim FAN 10R • swivel armchair • round base • Gas lift with memory • base: MetallicPro, Black RAL 9005, White RAL 9016, Deep Green RAL 6004, Navy Blue RAL 5003, Burgundy RAL 3005, Salvia/Green RAL 6021, Blue RAL 5014, Terracota RAL 3012		3 744	4 201	4 616	4 802	5 740	5 394	6 753
MFN100F000	Profim FAN 10F • swivel armchair • 4-star base • base: polished aluminum		4 090	4 507	4 923	5 120	6 045	5 740	7 058
MFN100Z000	Profim FAN 10Z • swivel armchair • Rocker mechanism • base: black		3 023	3 439	3 855	4 008	4 923	4 616	5 912

Item no	Base model +	Price Group (PG)	Price Group						Price
			0	①	②	③	④	⑤	
MFN100E000	Profim FAN 10E swivel armchair Economic mechanism base: black		2 724	3 157	3 573	3 716	4 648	4 334	5 637

MFN1000000	Profim FAN CU • seat cushion for FAN 10 version		412	428	497	705	860	912	968
------------	--	---	-----	-----	-----	-----	-----	-----	-----

Accessories/Options/Surcharges:

7TFRA010	Frame: HS - swivel version on glides (Only for: 10H)	287
7TFRA009	Frame: HC - version with castors (Only for: 10H)	344
7TFRA011	Frame: HW - wooden legs - beech wood: H5, H6, H12 (Only for: 10H)	1 272
7COPR002	Frames colours: MetallicPro, White RAL 9016, Deep Green RAL 6004, Navy Blue RAL 5003, Burgundy RAL 3005, Salvia/Green RAL 6021, Blue RAL 5014, Terracota RAL 3012 (Only for: 10H, 10V)	25
7COPR002	Frames colours: MetallicPro, White RAL 9016, Deep Green RAL 6004, Navy Blue RAL 5003, Burgundy RAL 3005, Salvia/Green RAL 6021, Blue RAL 5014, Terracota RAL 3012 (Only for: 20V)	48
7COPR006	Frame colour: Gold (Only for: 10H, 10V)	363
7COPR006	Frame colour: Gold (Only for: 20V)	715
7COPR003	Frames colours: Lightgrey; Grey , Metalsilver, Steelgray (Only for: 10H, 10R, 10V, 20V)	148
7BASC027	Base: MetallicPro (Only for: 10E, 10Z)	259
7BASC003	Base: polished aluminum (Only for: 10Z, 10E)	561
7CPLY010	Oak wood - HO6, HO12, HO11 (Only for: 10H)	227
7TGAS003	Gas lift with memory (Only for: 10F)	599

0 price group: Evo

1 price group: Cura, Tonal, Xtreme

2 price group: Select

3 price group: Capture, Oceanic, Step, Synergy

4 price group: Steelcut 3, Steelcut Trio 3

6 price group: Paloma

Castors / glides

Standard:

- universal castors (model 10HC),
- hard castors (models 10Z/10E),
- teflon glides - universal (models 10F/10H/10HS/10HW),
- hard glides - for soft floors (models 10V/20V).

Option:

- soft castors (models 10Z/10E),
- teflon glides - universal (10Z/10E),
- felt glides - for hard floors (10H/10HS/10HW/10V/20V/10F),
- felt pads under the base - for hard floors (model 10R).

















When ordering please clearly indicate the chosen option.

Model 10HW: wooden legs: beech wood - H5, H6, H12,

Two options of threads:

- upholstery matching threads
- decorative threads:

DECORATIVE THREADS

Color name		Approximate color from Pantone®
White		PANTONE 11-0608 TCX
Grey		PANTONE 18-0601 TCX
Dark grey		PANTONE 19-3901 TCX
Black		PANTONE 19-4004 TCX
Dark blue		PANTONE 19-3933 TCX
Blue		PANTONE 17-4139 TCX
Dark green		PANTONE 19-6050 TCX
Green		PANTONE 17-0324 TCX
Neon green		PANTONE 14-0340 TCX
Yellow		PANTONE 17-0949 TCX
Orange		PANTONE 17-1145 TCX
Neon orange		PANTONE 16-1364 TCX
Red		PANTONE 19-1758 TCX
Brown		PANTONE 14-1208 TCX
Beige		PANTONE 19-1218 TCX
Silver		PANTONE 14-4201 TCX

Option is available at no extra charge.



Frame version: 10HC





Frame version: 10HW



Profim MYTURN SOFA

Paul Brooks

- The collection includes an armchair and 2- and 3-seater sofas (on cantilever or legs)
- The collection is complemented by tables in two sizes

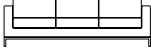
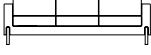
Item no	Base model +	Price Group (PG)	①	②	③	④	⑤	⑥	Price
MEX100H000	Profim MYTURN SOFA 10H • armchair • legs • frame: black		9 398	10 338	10 807	11 278	13 154	14 094	
MEX100V000	Profim MYTURN SOFA 10V • armchair • cantilever • frame: black		9 994	10 990	11 491	11 991	13 988	14 989	
MEX200H000	Profim MYTURN SOFA 20H • 2-seat sofa • legs • frame: black		13 135	14 448	15 104	15 759	18 389	19 701	
MEX200V000	Profim MYTURN SOFA 20V • 2-seat sofa • cantilever • frame: black		13 465	14 812	15 485	16 159	18 852	20 201	
MEX300H000	Profim MYTURN SOFA 30H • 3-seat sofa • legs • frame: black		16 731	18 404	19 241	20 078	23 425	25 099	
MEX300V000	Profim MYTURN SOFA 30V • 3-seat sofa • cantilever • frame: black		17 008	18 711	19 559	20 411	23 812	25 513	
Accessories/Options/Surcharges:									
7QUEL006	Quilting - outer surface (Q7) (Only for: 10H, 10V)								886

Accessories/Options/Surcharges:

7QUEL006	Quilting - outer surface (Q7) (Only for: 20H, 20V)	1 300
7QUEL006	Quilting - outer surface (Q7) (Only for: 30H, 30V)	1 511
7CFRA051	Frame: MetallicPro	33

1 price group: Cura, Tonal, Xtreme

2 price group: Select

3 price group: Capture, Oceanic, Step, Synergy

4 price group: Steelcut 3, Steelcut Trio 3

6 price group: Paloma

Glides

Standard:

- hard glides - for soft floors (models 10H/20H/30H),

- felt pads - for hard floors (models 10V/20V/30V).

Option:

- felt glides - for hard floors (models 10H/20H/30H).





When ordering please clearly indicate the chosen option.

Quilting - extra charge to all price groups, lead time 30-40 working days.

Profim MYTURN TABLE

Paul Brooks

- Tables in two sizes
- On cantilever or legs

Item no	Base model +	Price Group (PG)	①	②	Price
MEXS20H000	Profim MYTURN TABLE S2H • small table • 850 x 300 x 850 mm • legs • frame: black		7 252	7 977	
MEXS20V000	Profim MYTURN TABLE S2V • small table • 850 x 300 x 850 mm • cantilever • frame: black		8 304	9 134	
MEXS10H000	Profim MYTURN TABLE S1H • large table • 1200 x 300 x 850 mm • legs • frame: black		8 138	8 951	
MEXS10V000	Profim MYTURN TABLE S1V • large table • 1200 x 300 x 850 mm • cantilever • frame: black		9 190	10 108	

Accessories/Options/Surcharges:

7CFRA051	Frame: MetallicPro				33
----------	--------------------	--	--	--	----

1. Natural modified veneers (HM)

2.HPL

Colours of natural modified veneers (HM): HM10 (bleached oak), HM11 (classic oak), HM12 (cardinal oak), HM20 (venge classic) - lead time 20-30 working days.

Colours of HPL (LW): LW01 (white), LW02 (black), LW04 (grey) - lead time 20-30 working days.

Glides

Standard:

- hard glides - for soft floors (models S2H/S1H)
- felt pads - for hard floors (models S2V/S1V)

Option:





- felt glides - for hard floors (models S2H/S1H)

When ordering please clearly indicate the chosen option.

Profim NU

Paul Brooks

- The inner and outer sections of the shell may have different coloured fabrics
- The shell is mounted on several types of bases
- The cushion will increase the comfort of rest
- Möbelfakta certificate - a guarantee of durability, safety, environmental care and social responsibility during the production process

Item no	Base model +	Price Group (PG)	Price Group						Price
			0	①	②	③	④	⑤	
MNU200H000	Profim NU 20H • armchair • swivel • 4-legged • frame: black		3 666	3 819	4 203	4 393	4 585	5 345	7 945
MNU200V000	Profim NU 20V3 • armchair • wire frame • frame: black		3 587	3 736	4 111	4 298	4 484	5 231	7 782
MNU200R000	Profim NU 20R • swivel armchair • round base • base: MetallicPro, White RAL 9016, Deep Green RAL 6004, Navy Blue RAL 5003, Burgundy RAL 3005, Salvia/Green RAL 6021, Blue RAL 5014, Terracota RAL 3012		4 695	5 112	5 599	5 822	7 286	8 454	9 685
MNU200F000	Profim NU 20F • swivel armchair • 4-star base • base: polished aluminum		4 809	5 010	5 509	5 760	6 013	7 014	10 173

Accessories/Options/Surcharges:

7TFRA009	Frame: HC - version with castors - white / graphite / polished aluminum (Only for: 20H)	477
7TFRA011	Frame: HW - wooden legs - beech wood: H5, H6, H12 (Only for: 20H)	873
7COPR006	Frame colour: Gold (Only for: 20H, 20V3)	363
7SHQU006	Quilting - front side of the seat (Q5)	340
7TGAS003	Gas lift with memory (Only for: 20F, 20R)	576
7CFRA048	Frame: Blue RAL 5014 (Only for: 20H)	33
7CFRA033	Frame: Burgundy RAL 3005 (Only for: 20H)	33
7CFRA034	Frame: Deep green RAL 6004 (Only for: 20H)	33
7CFRA039	Frame: Grey (Only for: 20H)	148
7CFRA040	Frame: Lightgrey (Only for: 20H)	148

Accessories/Options/Surcharges:

7CFRA051	Frame: MetallicPro (Only for: 20H)	33
7CFRA046	Frame: Navy blue RAL 5003 (Only for: 20H)	33
7CFRA047	Frame: Salvia/Green RAL 6021 (Only for: 20H)	33
7CFRA049	Frame: Terracota RAL 3012 (Only for: 20H)	33
7CFRA056	Frame: White RAL 9016 (Only for: 20H)	33
7COPR003	Frames colours: Lightgrey; Grey (Only for: 20R, 20V3)	148
7COPR002	Frames colours: MetallicPro, White RAL 9016, Deep Green RAL 6004, Navy Blue RAL 5003, Burgundy RAL 3005, Salvia/Green RAL 6021, Blue RAL 5014, Terracota RAL 3012 (Only for: 20V3)	33

0 price group: Evo

1 price group: Cura, Tonal, Xtreme

2 price group: Select

3 price group: Capture, Oceanic, Step, Synergy

4 price group: Steelcut 3, Steelcut Trio 3

Glides

Standard:

- teflon glides – universal (models 20HS/20HW/20V3/20F).

Option (When ordering please clearly indicate the chosen option):

- hard castors - for soft floors (model 20H/20HC),

- soft castors - for hard floors (model 20H/20HC),

- teflon glides – universal (models 20H/20HS, 20HW),

- felt glides - for hard floors

Model 20HW: wooden legs: beech wood - H5, H6, H12.

Option of mixing colours of the same fabric according to below scheme:

A - cushion, B - inner part of the shell, C - outer part of the shell.

In case of order of such option, following example should be specified: SC-67097/SC-60132/SC-60999 (where SC-67097 - A, SC-60132 - B, SC-60999 - C).

Option is available at no extra charge.

Quilting - extra charge to all price groups, lead time 30-40 working days.



Frame version: 20HC



Frame version: 20HW



MÖBELFAKTA

Profim OCTOBER

Hilary Birkbeck

- Rich colours of finishes
- Possibility to use wooden legs
- Quilted cushions on the seat and backrest, finished with buttons
- Coffee tables come in two sizes, with a choice of two types of tops (wooden or wooden with glass insert)

Item no	Base model +	Price Group (PG)	①	②	③	④	⑤	⑥	Price
MOC1000000	Profim OCTOBER 10 • 1-seat pouffe • metal legs • frame: black		5 999	6 422	6 680	8 048	7 357	8 849	
MOC1100000	Profim OCTOBER 11 • armchair • metal legs • frame: black		8 511	9 187	9 553	12 067	12 421	16 534	
MOC1200000	Profim OCTOBER 12 • armchair • high backrest • metal legs • frame: black		10 191	11 110	11 555	15 687	15 632	21 765	
MOC2000000	Profim OCTOBER 20 • metal legs • frame: black		7 687	8 377	8 713	11 188	10 474	13 347	
MOC2100000	Profim OCTOBER 21 • 2-seat sofa • metal legs • frame: black		11 542	12 634	13 138	17 061	18 749	25 344	
MOC2200000	Profim OCTOBER 22 • 2-seat sofa • high backrest • metal legs • frame: black		13 929	15 287	15 898	21 709	22 919	31 924	

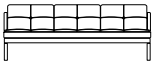
Item no	Base model +	Price Group (PG)	①	②	③	④	⑤	⑥	Price
MOC3100000	Profim OCTOBER 31 • 3-seat sofa • metal legs • frame: black		14 321	15 884	16 519	22 062	22 919	31 656	

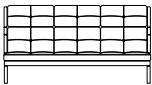
MOC3200000	Profim OCTOBER 32 • 3-seat sofa • high backrest • metal legs • frame: black		18 082	19 840	20 634	28 359	31 099	44 415	
------------	---	---	--------	--------	--------	--------	--------	--------	--

Accessories/Options/Surcharges:

7CFRA006	Frame: wood - beech wood: H5, H6, H12	1 300
7CFRA051	Frame: MetallicPro	8

1 price group: Cura, Tonal, Xtreme

2 price group: Select

3 price group: Capture, Oceanic, Step, Synergy

4 price group: Steelcut 3, Steelcut Trio 3

6 price group: Paloma

Glides

Standard:

- without glides - metal legs,

- hard glides - for soft floors - wooden legs.

Option:

-felt glides - for hard floors.

When ordering please clearly indicate the chosen option.

Wooden legs - standard colours of lacquer (H5, H6, H12) - lead time 20-30 working days.

Option of mixing colours of the same fabric on cushions and shell according to below scheme:

A - cushions on the seat and back, B - shell.



In case of order of such option, following example should be specified: SC-67097/SC-60132 (where SC-67097 - A, SC-60132 - B). Option is available at no extra charge.

Colour of buttons is always the same as the colour of cushions upholstery.

Profim OCTOBER TABLE

Hilary Birkbeck

- Two sizes and two types of tops (wooden or wooden with glass insert)

Item no	Base model +	Price Group (PG)	①	②	Price
MOCS200000	Profim OCTOBER TABLE S2 <ul style="list-style-type: none"> • small table • 600 x 350 x 600 mm • metal legs • frame: black 		7 011	7 395	
MOCS100000	Profim OCTOBER TABLE S1 <ul style="list-style-type: none"> • large table • 600 x 350 x 1200 mm • metal legs • frame: black 		8 597	9 021	
Accessories/Options/Surcharges:					
7CFRA003	Frame: metallic				
7CFRA006	Frame: wood - beech wood: H5, H6, H12				1 300

1. Wood

2. Wood/tempered glass (G1)

Wooden legs - standard colours of lacquer (H5, H6, H12) - lead time 20-30 working days.

Glides

Standard:

- without glides - metal legs,
- hard glides - for soft floors - wooden legs.

Option:

- felt glides - for hard floors.







When ordering please clearly indicate the chosen option.

Profim REVO

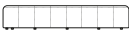
Pearson Lloyd

- Represents a radical rethinking of the way office furniture is made.
- Created from recycled and infinitely recyclable REPP, instead of plywood
- Includes sofas, benches, screens, stools and tables in softly contoured, organic shapes
- With 96 configurations can be customised to suit every workspace, whatever its function or size
- The weight of the product is reduced by 40% lowering the carbon footprint during production and transportation by 13% and 40% respectively.
- Manufactured without the use of glue or staples for easy disassembly

Item no	Base model +	Price Group (PG)	Price Group						Price
			0	①	②	③	④	⑤	
MRVP400000	Profim REVO P40 • Pouffe, • Ø 40 cm	 	3 742	3 899	4 288	4 484	4 678	5 459	7 998
MRVP600000	Profim REVO P60 • Pouffe, • Ø 60 cm	 	4 529	4 718	5 191	5 427	5 664	6 607	9 890
MRVSN15000	Profim REVO SN150 • Seat narrow, • lenght 150 cm	 	8 801	9 167	10 084	10 544	11 003	12 835	18 348
MRVSN21000	Profim REVO SN210 • Seat narrow, • lenght 210 cm	 	11 272	11 742	12 915	13 502	14 089	16 438	23 564
MRVSW12000	Profim REVO SW120 • Seat wide, • lenght 120 cm	 	9 320	9 708	10 678	11 163	11 649	13 591	19 309
MRVSW18000	Profim REVO SW180 • Seat wide, • lenght 180 cm	 	12 404	12 921	14 213	14 858	15 504	18 088	25 708

Item no	Base model +	Price Group (PG)	Price Group						Price
			0	①	②	③	④	⑤	
MRVSW24000	Profim REVO SW240 • Seat wide, • lenght 240 cm	 	15 403	16 044	17 649	18 450	19 252	22 462	31 908
MRVB900000	Profim REVO B90 • Backrest, • lenght 90 cm		3 344	3 483	3 831	4 005	4 180	4 876	7 119
MRVB120000	Profim REVO B120 • Backrest, • lenght 120 cm		4 002	4 169	4 586	4 795	5 003	5 835	8 500
MRVB180000	Profim REVO B180 • Backrest, • lenght 180 cm		5 694	5 932	6 524	6 822	7 118	8 305	12 117
MRVW900000	Profim REVO W90 • Screen, • wide 90 cm		4 832	5 033	5 537	5 788	6 039	7 047	10 747
MRVW120000	Profim REVO W120 • Screen, • wide 120 cm		6 137	6 392	7 033	7 352	7 671	8 950	13 706
MRVW180000	Profim REVO W180 • Screen, • wide 180 cm		8 196	8 538	9 394	9 820	10 246	11 954	18 714

Accessories/Options/Surcharges:

7ELEC004	Mediaport - electrical outlet 230V and USB-C (Only for: P60, SN150, SN210, SW120, SW180, SW240)	1904
7TFOA003	Flame retardant foam BS 5852 (Only for: B120, B180, B90, P40, P60, SN150, SN210, SW120, SW180, SW240)	565

0 price group: Evo

1 price group: Cura, Tonal, Xtreme

2 price group: Select

3 price group: Capture, Oceanic, Step, Synergy

4 price group: Steelcut 3, Steelcut Trio 3

For Valencia and Silvertex (extended) fabrics - no quilting on the seat modules

Glides:

- standard - teflon glides (universal).

- option - felt glides (for hard floors).

When ordering please clearly indicate the chosen option.

Individual modules allow to create various types of systems / sets depending on your needs. A full list of possible configurations is available through the configurator on the

website www.profim.eu or directly at the link: [CONFIGURATOR pCon](#).

The price for a configured set is the amount of the value of each module of a given set.

Possibility to freely choose the type of upholstery for individual elements within a given set (e.g. seat: Select, backrest: Synergy, screen: Sprint).

The screens can only be combined with wide seats: SW120, SW160 or SW240.

It is not possible to purchase the screen as a free-standing module.







www.blauer-engel.de/uz117

Profim SNAP

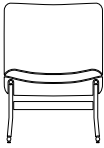
Note Design Studio

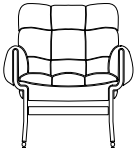
- Snap armchair epitomizes comfort and style, designed to maximize user comfort.
- Snap collection offers two distinct aesthetics: the softer and more expressive Fluffy (21H) and the slim and delicate Slim (20H).
- Designed to support the body and promote well-being in the workplace, Snap enhances employee productivity.
- Created with sustainability in mind, Snap employs innovative technologies and environmentally friendly materials, minimizing the negative impact on the planet while maintaining high quality and durability.
- Snap is certified by the EU Ecolabel, Möbelfakta, Greenguard, and EPD.
- The seat is composed of up to 75% recycled polypropylene, while the back is made of up to 70% recycled polyamide. The carbon footprint of the Slim 20H version is 49.38 kg, and the Fluffy 21H version is 53.31 kg.

Item no	Base model +	Price Group (PG)	Price Group						Price
			0	①	②	③	④	⑤	
MNL200H000	Profim SNAP 20H <ul style="list-style-type: none"> • lounge chair • slim version • without armrests • upholstered seat and backrest • metal legs • frame: MetallicPro; Black RAL 9005; White RAL 9016; Deep Green RAL 6004; Navy Blue RAL 5003; Burgundy RAL 3005; Salvia/Green RAL 6021; Blue RAL 5014; Terracota RAL 3012 		5 954	6 285	6 616	7 872	8 799	9 990	11 445
MNL210H000	Profim SNAP 21H <ul style="list-style-type: none"> • lounge chair • fluffy version • without armrests • upholstered seat and backrest, with additional cushions • metal legs • frame: MetallicPro; Black RAL 9005; White RAL 9016; Deep Green RAL 6004; Navy Blue RAL 5003; Burgundy RAL 3005; Salvia/Green RAL 6021, Blue RAL 5014; Terracota RAL 3012 		7 938	8 380	8 820	10 496	11 731	13 319	15 260
MNL210HP00	Profim Snap 21H 2PF <ul style="list-style-type: none"> • lounge chair • fluffy version • metal armrests • upholstered armrest covers • upholstered seat and backrest, with additional cushions • metal legs • frame: MetallicPro; Black RAL 9005; White RAL 9016; Deep Green RAL 6004; Navy Blue RAL 5003; Burgundy RAL 3005; Salvia/Green RAL 6021, Blue RAL 5014; Terracota RAL 3012 		9 943	10 647	11 461	13 376	16 000	18 047	21 469
MNL0000000	Profim SNAP F <ul style="list-style-type: none"> • upholstered armrest covers • separate element • applied only in 21H 2P version (with armrests) 		1 012	1 275	1 648	1 887	3 276	3 735	5 217
Accessories/Options/Surcharges:									
7ARMR023	2P - Metal armrests (Only for: 20H, 21H)								993
7CFRA025	Frame : metalsilver (Only for: 20H, 21H, 21H 2PF)								171
7CFRA039	Frame: Grey (Only for: 20H, 21H, 21H 2PF)								148

Accessories/Options/Surcharges:

7CFRA040

Frame: Lightgrey (Only for: 20H, 21H, 21H 2PF)

148

0 price group: Evo

1 price group: Cura, Tonal, Xtreme

2 price group: Select

3 price group: Capture, Oceanic, Step, Synergy

4 price group: Steelcut 3, Steelcut Trio 3

6 price group: Paloma

Glides:

- standard - teflon glides (universal).

- option - felt glides (for hard floors).

When ordering please clearly indicate the chosen option.

Glides colour matched to frame colour:

White: Metalsilver; MetallicPro; White / RAL 9016; Light Grey / NCS S 2500 N; Salvia/Green / RAL 6021; Blue / RAL 5014; Terracota / RAL 3012

Black: Black / RAL 9005; Grey / NCS S 6500 N; Deep Green / RAL 6004; Navy Blue / RAL 5003; Burgundy / RAL 3005

2P - metal armrest always in the same color as the armchair frame

Upholstered armrest covers always in the same fabric as chair.

Snap F - It is possible to purchase an armrest covers later for self-assembly.



Profim SOFTBOX

Paul Brooks

- Modular system
- Aluminium legs with original shape
- Screens enabling space separation and improving acoustic conditions in rooms
- Possibility to choose different upholstery colours
- Stabilizing connectors for neighbouring elements included

Item no	Base model +	Price Group (PG)	①	②	③	④	⑤	⑥	Price
MSF1000000	Profim SOFTBOX 10 • pouffe • frame: black		8 262	9 089	9 501	9 917	11 566	12 393	
MSF1C00000	Profim SOFTBOX 1C • corner armchair • frame: black		10 849	11 934	12 478	13 019	15 189	16 277	
MSF1C00W00	Profim SOFTBOX 1CW • to assemble with screen • prices the same as the model 1C (MSF1C00000) • add the price of the screen from the accessory list								
MSF1100000	Profim SOFTBOX 11 • armchair • frame: black		12 136	13 350	13 958	14 565	16 992	18 206	
MSF1100W00	Profim SOFTBOX 11W • to assemble with screen • prices the same as the model 11 (MSF1100000) • add the price of the screen from the accessory list								
MSF2000000	Profim SOFTBOX 20 • 2-seat pouffe • frame: black		10 767	11 844	12 382	12 922	15 075	16 153	

Item no	Base model +	Price Group (PG)	①	②	③	④	⑤	⑥	Price
MSF2B00000	Profim SOFTBOX 2B <ul style="list-style-type: none"> • 2-seat sofa • frame: black • without armrests 		14 092	15 027	15 628	18 686	19 180	37 121	
MSF2B00W00	Profim SOFTBOX 2BW <ul style="list-style-type: none"> • to assemble with screen • prices the same as the model 2B (MSF2B00000) • add the price of the screen from the accessory list 								
MSF2R00000	Profim SOFTBOX 2R <ul style="list-style-type: none"> • 2-seat sofa • frame: black • armrest on right side 		15 430	16 975	17 746	18 518	21 604	23 146	
MSF2R00W00	Profim SOFTBOX 2RW <ul style="list-style-type: none"> • to assemble with screen • prices the same as the model 2R (MSF2R00000) • add the price of the screen from the accessory list 								
MSF2L00000	Profim SOFTBOX 2L <ul style="list-style-type: none"> • 2-seat sofa • frame: black • armrest on left side 		15 430	16 975	17 746	18 518	21 604	23 146	
MSF2L00W00	Profim SOFTBOX 2LW <ul style="list-style-type: none"> • to assemble with screen • prices the same as the model 2L (MSF2L00000) • add the price of the screen from the accessory list 								
MSF2100000	Profim SOFTBOX 21 <ul style="list-style-type: none"> • 2-seat sofa • frame: black • with armrests 		16 012	17 614	18 414	19 214	22 419	24 020	

Item no	Base model +	Price Group (PG)	①	②	③	④	⑤	⑥	Price
MSF2100W00	Profim SOFTBOX 21W • to assemble with screen • prices the same as the model 21 (MSF2100000) • add the price of the screen from the accessory list								
MSF3B00000	Profim SOFTBOX 3B • 3-seat sofa • frame: black • without armrests		18 324	20 155	21 073	21 989	25 653	27 485	
MSF3B00W00	Profim SOFTBOX 3BW • to assemble with screen • prices the same as the model 3B (MSF3B00000) • add the price of the screen from the accessory list								
MSF3R00000	Profim SOFTBOX 3R • 3-seat sofa • frame: black • armrest on right side		19 971	21 966	22 964	23 965	27 959	29 957	
MSF3R00W00	Profim SOFTBOX 3RW • to assemble with screen • prices the same as the model 3R (MSF3R00000) • add the price of the screen from the accessory list								
MSF3L00000	Profim SOFTBOX 3L • 3-seat sofa • frame: black • armrest on left side		19 971	21 966	22 964	23 965	27 959	29 957	
MSF3L00W00	Profim SOFTBOX 3LW • to assemble with screen • prices the same as the model 3L (MSF3L00000) • add the price of the screen from the accessory list								

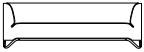
Item no	Base model +	Price Group (PG)	①	②	③	④	⑤	⑥	Price
MSF3100000	Profim SOFTBOX 31 • 3-seat sofa • frame: black • with armrests		20 607	22 668	23 699	24 729	28 849	30 911	

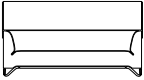
MSF3100W00	Profim SOFTBOX 31W • to assemble with screen • prices the same as the model 31 (MSF3100000) • add the price of the screen from the accessory list								
------------	--	---	--	--	--	--	--	--	--

MSFS2000000	Profim SOFTBOX TABLE S2 • square table • frame: black		9 464	10 289	10 702	11 115	12 768	13 594	
-------------	---	---	-------	--------	--------	--------	--------	--------	--

Accessories/Options/Surcharges:

7CFRA005	Frame: polished aluminum (Only for: 10, 11, 11W, 1C, 1CW, S2)	967
7CFRA005	Frame: polished aluminum (Only for: 20, 21, 21W, 2B, 2BW, 2L, 2LW, 2R, 2RW)	2 209
7CFRA005	Frame: polished aluminum (Only for: 31, 31W, 3B, 3BW, 3L, 3LW, 3R, 3RW)	3 492
7CFRA006	Frame: wood - H6, H12, H5 (Only for: 10, 11, 11W, 1C, 1CW, S2)	4 460
7CFRA006	Frame: wood - H6, H12, H5 (Only for: 20, 21, 21W, 2B, 2BW, 2L, 2LW, 2R, 2RW)	6 138
7CFRA006	Frame: wood - H6, H12, H5 (Only for: 31, 31W, 3B, 3BW, 3L, 3LW, 3R, 3RW)	7 761
7COPR002	Frames colours: MetallicPro, White RAL 9016, Deep Green RAL 6004, Navy Blue RAL 5003, Burgundy RAL 3005, Salvia/Green RAL 6021, Blue RAL 5014, Terracota RAL 3012	26
7COPR003	Frames colours: Lightgrey; Grey	159
	Table top HPL (LW): LW01 (white), LW02 (black), LW04 (grey) (Only for: S2)	1 453
	Table top - natural modified veneers (HM): HM10 (bleached oak), HM11 (classic oak), HM12 (cardinal oak), HM20 (venge classic) (Only for: S2)	1 453
	Screen (W) - extra charge to 1 price group (Only for: 11W)	4 898
	Screen (W) - extra charge to 1 price group (Only for: 1CW)	4 751
	Screen (W) - extra charge to 1 price group (Only for: 21W)	6 960
	Screen (W) - extra charge to 1 price group (Only for: 2BW)	5 434
	Screen (W) - extra charge to 1 price group (Only for: 2LW, 2RW)	6 092
	Screen (W) - extra charge to 1 price group (Only for: 31W)	7 537
	Screen (W) - extra charge to 1 price group (Only for: 3BW)	6 026
	Screen (W) - extra charge to 1 price group (Only for: 3LW, 3RW)	6 766
	Screen (W) - extra charge to 2 price group (Only for: 11W)	5 547
	Screen (W) - extra charge to 2 price group (Only for: 1CW)	5 198

Accessories/Options/Surcharges:

Screen (W) - extra charge to 2 price group (Only for: 21W)	7 821
Screen (W) - extra charge to 2 price group (Only for: 2BW)	6 034
Screen (W) - extra charge to 2 price group (Only for: 2LW, 2RW)	6 766
Screen (W) - extra charge to 2 price group (Only for: 31W)	8 520
Screen (W) - extra charge to 2 price group (Only for: 3BW)	6 734
Screen (W) - extra charge to 2 price group (Only for: 3LW, 3RW)	7 554
Screen (W) - extra charge to 3 price group (Only for: 11W)	5 547
Screen (W) - extra charge to 3 price group (Only for: 1CW)	5 198
Screen (W) - extra charge to 3 price group (Only for: 21W)	7 821
Screen (W) - extra charge to 3 price group (Only for: 2BW)	6 034
Screen (W) - extra charge to 3 price group (Only for: 2LW, 2RW)	6 766
Screen (W) - extra charge to 3 price group (Only for: 31W)	8 520
Screen (W) - extra charge to 3 price group (Only for: 3BW)	6 734
Screen (W) - extra charge to 3 price group (Only for: 3LW, 3RW)	7 554
Screen (W) - extra charge to 4 price group (Only for: 11W)	7 001
Screen (W) - extra charge to 4 price group (Only for: 1CW)	6 588
Screen (W) - extra charge to 4 price group (Only for: 21W)	10 007
Screen (W) - extra charge to 4 price group (Only for: 2BW)	7 497
Screen (W) - extra charge to 4 price group (Only for: 2LW, 2RW)	8 520
Screen (W) - extra charge to 4 price group (Only for: 31W)	11 346
Screen (W) - extra charge to 4 price group (Only for: 3BW)	8 691
Screen (W) - extra charge to 4 price group (Only for: 3LW, 3RW)	9 957
Screen (W) - extra charge to 5 price group (Only for: 11W)	8 376
Screen (W) - extra charge to 5 price group (Only for: 1CW)	7 849
Screen (W) - extra charge to 5 price group (Only for: 21W)	11 810
Screen (W) - extra charge to 5 price group (Only for: 2BW)	9 113
Screen (W) - extra charge to 5 price group (Only for: 2LW, 2RW)	10 217
Screen (W) - extra charge to 5 price group (Only for: 31W)	12 866
Screen (W) - extra charge to 5 price group (Only for: 3BW)	10 167
Screen (W) - extra charge to 5 price group (Only for: 3LW, 3RW)	11 405
Screen (W) - extra charge to 6 price group (Only for: 11W)	9 596
Screen (W) - extra charge to 6 price group (Only for: 1CW)	8 991
Screen (W) - extra charge to 6 price group (Only for: 21W)	13 530
Screen (W) - extra charge to 6 price group (Only for: 2BW)	10 440
Screen (W) - extra charge to 6 price group (Only for: 2LW, 2RW)	11 705
Screen (W) - extra charge to 6 price group (Only for: 31W)	14 740
Screen (W) - extra charge to 6 price group (Only for: 3BW)	11 649
Screen (W) - extra charge to 6 price group (Only for: 3LW, 3RW)	13 066
7ELEC004 Mediaport - electrical outlet 230V and USB-C (Only for: 2L, 2LW, 2R, 2RW, 3L, 3LW, 3R, 3RW)	1 933

Accessories/Options/Surcharges:

7ELEC003	Mediaport (mounted on the right side) - electrical outlet 230V and USB-C (Only for: 1C)	1933
7ELEC001	Mediaport (mounted on the left side) - electrical outlet 230V and USB-C (Only for: 1C)	1933

1 price group: Cura, Tonal, Xtreme

2 price group: Select

3 price group: Capture, Oceanic, Step, Synergy

4 price group: Steelcut 3, Steelcut Trio 3

6 price group: Paloma

Glides

Standard:

- teflon glides - universal.

Option:

- felt glides - for hard floors.

When ordering please clearly indicate the chosen option.

Table top G1 - lead time 20-30 working days.

Option of mixing colours of the same fabric on cushions and shell according to below scheme:

A - inner shell part, B - outer shell part.

In case of order of such option, following example should be specified: SC-67097/SC-60132 (where SC-67097 - A, SC-60132 - B). Option is available at no extra charge.

Set of linking parts for stabilizing adjoining elements as standard.

In bigger models, differences resulting from the hardness of polyurethane cold-moulded foam due to parameter variations within the range of +/-10% (as acceptable according to the DIN 53576/ISO 2439 norm) can be noticeable.

For better set-stability, it is possible to join the screens with linking parts:

- 1CW - option of joining from the right, left or both sides of the screen.

- 2BW - option of joining from the right, left or both sides of the screen.

- 2LW - option of joining only from the right side of the screen,

- 2RW - option of joining only from the left side of the screen.

- 3BW - option of joining from the right, left or both sides of the screen,

- 3RW - option of joining only from the left side of the screen.

- 3LW - option of joining only from the right side of the screen.

Please indicate clearly on your order which joining option is required.

It's not possible to assemble the screen with the armchair/sofa without preparing it at the manufacture stage.

The seat and screen can be in different price groups.

Profim SORRISO

Jarosław Szymański, Studio 1:1

- Three base options: cantilever, four-star base or flat base
- Möbelfakta certificate - a guarantee of durability, safety, environmental care and social responsibility during the production process

Item no	Base model +	Price Group (PG)	Price Group						Price
			0	①	②	③	④	⑤	
MSY100V000	Profim SORRISO 10V • armchair • wire frame • frame: black		3 682	4 075	4 805	4 997	6 516	5 944	7 860

Accessories/Options/Surcharges:

7COPR002	Frames colours: MetallicPro, White RAL 9016, Deep Green RAL 6004, Navy Blue RAL 5003, Burgundy RAL 3005, Salvia/Green RAL 6021, Blue RAL 5014, Terracota RAL 3012	26
7COPR003	Frames colours: Lightgrey; Grey	159
7SHQU006	Quilting - front side of the seat (Q5)	350

0 price group: Evo

1 price group: Cura, Tonal, Xtreme

2 price group: Select

3 price group: Capture, Oceanic, Step, Synergy

4 price group: Steelcut 3, Steelcut Trio 3

6 price group: Paloma

Castors / glides

Standard:

- teflon glides – universal

Option:

- felt glides – for hard floors

When ordering please clearly indicate the chosen option.

Option of mixing colours of the same fabric on shell and cushion according to below scheme:

A - cushion colour, B - shell colour.



In case of order of such option, following example should be specified: SC-67097/SC-60132 (where SC-67097 - A, SC-60132 - B). Option is available at no extra charge.





Quilting - extra charge to all price groups, lead time 30-40 working days.



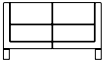
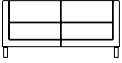
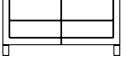

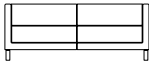
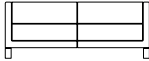
Profim VANCOUVER LITE

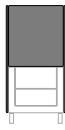
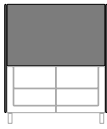
- Armchairs and sofas (in three sizes) come on metal cantilever and metal or wooden legs
- Complementary elements include a TV mount and media ports
- The collection is complemented by a simple wall which is used to connect the set in the shape of the letter "U"

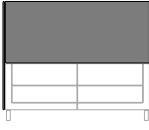
Item no	Base model +	Price Group (PG)	Price Group						Price
			0	①	②	③	④	⑤	
MVT100H000	Profim VANCOUVER LITE VL1 H • armchair • legs • frame: MetallicPro; Black RAL 9005; White RAL 9016; Deep Green RAL 6004; Navy Blue RAL 5003; Burgundy RAL 3005; Salvia/Green RAL 6021, Blue RAL 5014; Terracota RAL 3012, wooden legs		4 490	4 677	5 146	5 380	5 614	6 550	7 017
MVT100V000	Profim VANCOUVER LITE VL1 V • armchair • cantilevers • frame: MetallicPro; Black RAL 9005; White RAL 9016; Deep Green RAL 6004; Navy Blue RAL 5003; Burgundy RAL 3005; Salvia/Green RAL 6021, Blue RAL 5014; Terracota RAL 3012		4 877	5 080	5 586	5 840	6 094	7 110	7 620
MVT200H000	Profim VANCOUVER LITE VL2 H • 2-seat sofa • legs • frame: MetallicPro; Black RAL 9005; White RAL 9016; Deep Green RAL 6004; Navy Blue RAL 5003; Burgundy RAL 3005; Salvia/Green RAL 6021, Blue RAL 5014; Terracota RAL 3012, wooden legs		5 594	5 826	6 409	6 700	6 992	8 159	8 738
MVT200V000	Profim VANCOUVER LITE VL2 V • 2-seat sofa • cantilevers • frame: MetallicPro; Black RAL 9005; White RAL 9016; Deep Green RAL 6004; Navy Blue RAL 5003; Burgundy RAL 3005; Salvia/Green RAL 6021, Blue RAL 5014; Terracota RAL 3012		5 978	6 227	6 852	7 164	7 473	8 719	9 342
MVT250H000	Profim VANCOUVER LITE VL2,5H • 2,5-seat sofa • legs • frame: MetallicPro; Black RAL 9005; White RAL 9016; Deep Green RAL 6004; Navy Blue RAL 5003; Burgundy RAL 3005; Salvia/Green RAL 6021, Blue RAL 5014; Terracota RAL 3012, wooden legs		6 297	6 559	7 217	7 542	7 871	9 184	9 839
MVT250V000	Profim VANCOUVER LITE VL2,5V • 2,5-seat sofa • cantilevers • frame: MetallicPro; Black RAL 9005; White RAL 9016; Deep Green RAL 6004; Navy Blue RAL 5003; Burgundy RAL 3005; Salvia/Green RAL 6021, Blue RAL 5014; Terracota RAL 3012		6 684	6 962	7 657	8 006	8 353	9 746	10 442

Item no	Base model +	Price Group (PG)	Price Group						Price
			0	①	②	③	④	⑤	
MVT300H000	Profim VANCOUVER LITE VL3 H <ul style="list-style-type: none"> 3-seat sofa legs frame: MetallicPro; Black RAL 9005; White RAL 9016; Deep Green RAL 6004; Navy Blue RAL 5003; Burgundy RAL 3005; Salvia/Green RAL 6021, Blue RAL 5014; Terracota RAL 3012, wooden legs 		7 826	8 151	8 964	9 376	9 783	11 412	12 228
MVT300V000	Profim VANCOUVER LITE VL3 V <ul style="list-style-type: none"> 3-seat sofa cantilevers frame: MetallicPro; Black RAL 9005; White RAL 9016; Deep Green RAL 6004; Navy Blue RAL 5003; Burgundy RAL 3005; Salvia/Green RAL 6021, Blue RAL 5014; Terracota RAL 3012 		8 211	8 552	9 409	9 837	10 264	11 975	12 831
MVTSW00000	Profim VANCOUVER LITE VL SW <ul style="list-style-type: none"> straight connecting wall 		1 608	1 675	1 842	1 925	2 010	2 344	
MVTW100000	Profim VANCOUVER LITE VL W1 <ul style="list-style-type: none"> set of partition walls to be connected with armchair 		5 207	5 425	5 967	6 238	6 509	7 595	
MVTW200000	Profim VANCOUVER LITE VL W2 <ul style="list-style-type: none"> set of partition walls to be connected with 2-seater sofa 		5 912	6 159	6 775	7 082	7 390	8 621	
MVTW250000	Profim VANCOUVER LITE VL W2,5 <ul style="list-style-type: none"> set of partition walls to be connected with 2,5-seater sofa 		6 737	7 017	7 718	8 069	8 420	9 823	
MVTW300000	Profim VANCOUVER LITE VL W3 <ul style="list-style-type: none"> set of partition walls to be connected with 3-seater sofa 		8 398	8 748	9 621	10 060	10 497	12 246	

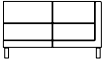
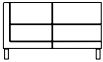
Item no	Base model +	Price Group (PG)	Price Group						Price
			0	①	②	③	④	⑤	
MVT1C0H000	Profim Vancouver Lite VL1C H <ul style="list-style-type: none"> central corner sofa module not to be used alone, only in combination with the left and right seats legs frame: MetallicPro; Black RAL 9005; White RAL 9016; Deep Green RAL 6004; Navy Blue RAL 5003; Burgundy RAL 3005; Salvia/Green RAL 6021, Blue RAL 5014; Terracota RAL 3012, chrome, wooden legs 		4 273	4 522	4 969	5 168	5 516	6 410	7 155
MVT1L0H000	Profim Vancouver Lite VL1L H <ul style="list-style-type: none"> left 1-seat corner sofa module not to be used alone, only in combination with the central corner sofa module (VL1C H) legs frame: MetallicPro; Black RAL 9005; White RAL 9016; Deep Green RAL 6004; Navy Blue RAL 5003; Burgundy RAL 3005; Salvia/Green RAL 6021, Blue RAL 5014; Terracota RAL 3012, chrome, wooden legs 		4 142	4 383	4 816	5 009	5 346	6 213	6 935
MVT1R0H000	Profim Vancouver Lite VL1R H <ul style="list-style-type: none"> right 1-seat corner sofa module not to be used alone, only in combination with the central corner sofa module (VL1C H) legs frame: MetallicPro; Black RAL 9005; White RAL 9016; Deep Green RAL 6004; Navy Blue RAL 5003; Burgundy RAL 3005; Salvia/Green RAL 6021, Blue RAL 5014; Terracota RAL 3012, chrome, wooden legs 		4 142	4 383	4 816	5 009	5 346	6 213	6 935
MVT2L0H000	Profim Vancouver Lite VL2L H <ul style="list-style-type: none"> left 2-seat corner sofa module not to be used alone, only in combination with the central corner sofa module (VL1C H) legs frame: MetallicPro; Black RAL 9005; White RAL 9016; Deep Green RAL 6004; Navy Blue RAL 5003; Burgundy RAL 3005; Salvia/Green RAL 6021, Blue RAL 5014; Terracota RAL 3012, chrome, wooden legs 		5 158	5 458	5 998	6 238	6 658	7 737	8 637
MVT2R0H000	Profim Vancouver Lite VL2R H <ul style="list-style-type: none"> right 2-seat corner sofa module not to be used alone, only in combination with the central corner sofa module (VL1C H) legs frame: MetallicPro; Black RAL 9005; White RAL 9016; Deep Green RAL 6004; Navy Blue RAL 5003; Burgundy RAL 3005; Salvia/Green RAL 6021, Blue RAL 5014; Terracota RAL 3012, chrome, wooden legs 		5 158	5 458	5 998	6 238	6 658	7 737	8 637

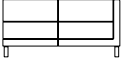
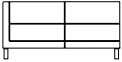
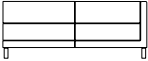
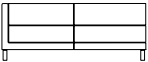
Item no	Base model +	Price Group (PG)	Price Group						Price
			0	①	②	③	④	⑤	
MVT25LH000	Profim Vancouver Lite VL2,5L H • left 2,5-seat corner sofa module • not to be used alone, only in combination with the central corner sofa module (VL1C H) • legs • frame: MetallicPro; Black RAL 9005; White RAL 9016; Deep Green RAL 6004; Navy Blue RAL 5003; Burgundy RAL 3005; Salvia/Green RAL 6021, Blue RAL 5014; Terracota RAL 3012, chrome, wooden legs		5 809	6 147	6 755	7 025	7 498	8 714	9 727
MVT25RH000	Profim Vancouver Lite VL2,5R H • right 2,5-seat corner sofa module • not to be used alone, only in combination with the central corner sofa module (VL1C H) • legs • frame: MetallicPro; Black RAL 9005; White RAL 9016; Deep Green RAL 6004; Navy Blue RAL 5003; Burgundy RAL 3005; Salvia/Green RAL 6021, Blue RAL 5014; Terracota RAL 3012, chrome, wooden legs		5 809	6 147	6 755	7 025	7 498	8 714	9 727
MVT3L0H000	Profim Vancouver Lite VL3L H • left 3-seat corner sofa module • not to be used alone, only in combination with the central corner sofa module (VL1C H) • legs • frame: MetallicPro; Black RAL 9005; White RAL 9016; Deep Green RAL 6004; Navy Blue RAL 5003; Burgundy RAL 3005; Salvia/Green RAL 6021, Blue RAL 5014; Terracota RAL 3012, chrome, wooden legs		5 789	7 048	8 390	8 726	12 333	13 256	14 515
MVT3R0H000	Profim Vancouver Lite VL3R H • right 3-seat corner sofa module • not to be used alone, only in combination with the central corner sofa module (VL1C H) • legs • frame: MetallicPro; Black RAL 9005; White RAL 9016; Deep Green RAL 6004; Navy Blue RAL 5003; Burgundy RAL 3005; Salvia/Green RAL 6021, Blue RAL 5014; Terracota RAL 3012, chrome, wooden legs		5 789	7 048	8 390	8 726	12 333	13 256	14 515
Accessories/Options/Surcharges:									
7COPR003	Frames colours: Lightgrey; Grey (Only for: VL1 H, VL1 V, VL1C H, VL1L H, VL1R H, VL2 H, VL2 V, VL2,5H, VL2,5V, VL2,5L H, VL2,5R H, VL2L H, VL2R H, VL3 H, VL3 V, VL3L H, VL3R H)							159	
7TFRA013	Connecting with walls (HW/VW) (Only for: VL1 H, VL1 V)							309	
7TFRA013	Connecting with walls (HW/VW) (Only for: VL2 H, VL2 V)							537	
7TFRA013	Connecting with walls (HW/VW) (Only for: VL2,5H, VL2,5V, VL3 H, VL3 V)							707	
7QUEL004	Quilting - inner surface (Q6) (Only for: VL SW)							1 819	
7QUEL004	Quilting - inner surface (Q6) (Only for: VL W1)							2 096	
7QUEL004	Quilting - inner surface (Q6) (Only for: VL W2)							2 899	
7QUEL004	Quilting - inner surface (Q6) (Only for: VL W2,5)							3 297	
7QUEL004	Quilting - inner surface (Q6) (Only for: VL W3)							7 416	
7QUEL006	Quilting - outer surface (Q7) (Only for: VL1 H, VL1 V)							877	

Accessories/Options/Surcharges:

7QUEL006	Quilting - outer surface (Q7) (Only for: VL2 H, VL2 V)	1 146
7QUEL006	Quilting - outer surface (Q7) (Only for: VL2,5H, VL2,5V)	1 275
7QUEL006	Quilting - outer surface (Q7) (Only for: VL3 H, VL3 V)	1 616
7QUEL006	Quilting - outer surface (Q7) (Only for: VL SW)	2 153
7QUEL006	Quilting - outer surface (Q7) (Only for: VL W1)	2 566
7QUEL006	Quilting - outer surface (Q7) (Only for: VL W2)	3 518
7QUEL006	Quilting - outer surface (Q7) (Only for: VL W2,5)	3 899
7QUEL006	Quilting - outer surface (Q7) (Only for: VL W3)	9 032
7TFRA016	TV handle (SW HA) (Only for: VL SW)	1 446
7ELEC004	Mediaport - electrical outlet 230V and USB-C (Only for: VL1 H, VL1 V, VL2 H, VL2 V, VL2,5H, VL2,5V, VL3 H, VL3 V)	1 901

0 price group: Evo

1 price group: Cura, Tonal, Xtreme

2 price group: Select

3 price group: Capture, Oceanic, Step, Synergy

4 price group: Steelcut 3, Steelcut Trio 3

6 price group: Paloma

Glides

Standard:

- hard glides - for soft floors (models H)

- felt pads - for hard floors (models V)

Option:

- felt glides - for hard floors (models H)

When ordering please clearly indicate the chosen option.

Wooden legs: beech wood - H5, H6, H12.

In VL W1, VL W2, VL W2,5, VL W3 option of mixing colours of the same fabric on inner and outer part of the partition wall according to below scheme:

A - inner part of shell, B - outer part of shell.

In case of order of such option, following example should be specified: SC-67097/SC-60132 (gdzie SC-67097 - A, SC-60132 - B). Option is available at no extra charge.

While ordering set of "U-shape" armchairs/sofas (including wall VL SW) please indicate clearly this option on your order. Distance between the seats in "U-shape set" - 940 mm.

Quilting - extra charge to all price groups, lead time 30-40 working days.

SW HA - acceptable dimension of TV: max. diagonal of the screen - 40 inches, max. weight - 10 kg.



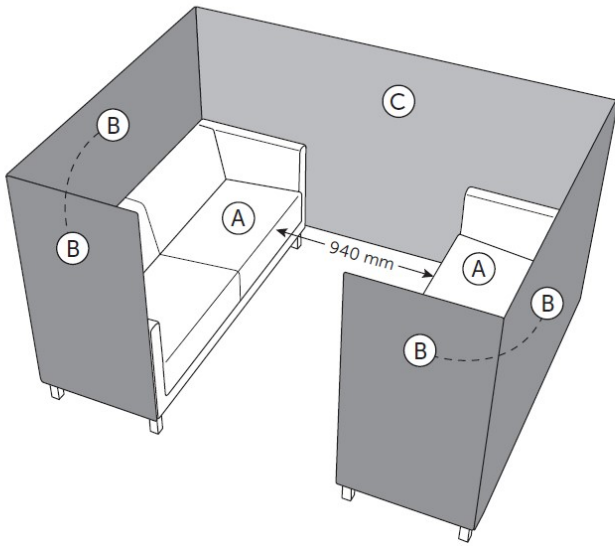

Sample of „U-shape” set with 3-seater sofas.

2 x A: VL 3 HW/VW
 (3-seat sofa, to be connected with partition walls)

2x B: VL W3
 (set of partition walls to be connected with 3-seater sofa)

1 x SW: VL SW
 (wall)

While ordering set of "U-shape" armchairs/sofas (including wall VL SW) please indicate clearly this option on your order.

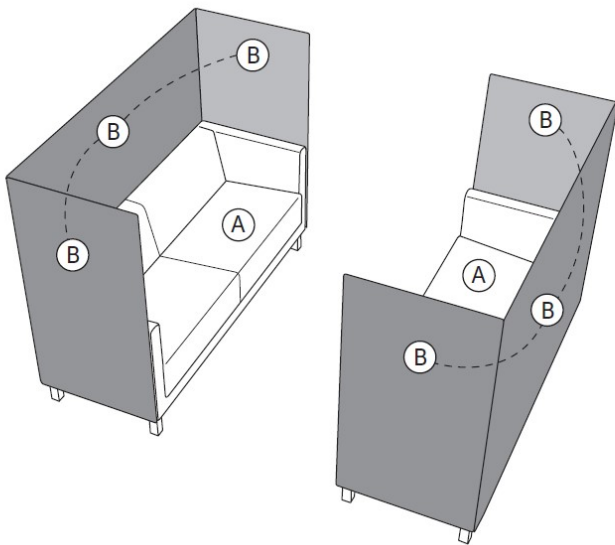









Sample of set with separate 3-seater sofas.

2 x A: VL 3 HW/VW
 (3-seat sofa, to be connected with partition walls)

2 x B: VL W3
 (set of partition walls to be connected with 3-seater sofa).

Profim VANCOUVER OTO

- Available in two sizes and two shapes
- The set is also available as a pouffe + table in the version with an added glass top
- Possibility of connecting cubic pouffes by means of a linking element
- The mediaport is a complementary element

Item no	Base model +	Price Group (PG)	Price Group						Price
			0	①	②	③	④	⑤	
MVOR200000	Profim VANCOUVER OTO VOR2 • small round pouffe • ø 410 mm	 	1303	1358	1493	1559	1628	1898	2034
MVOR100000	Profim VANCOUVER OTO VOR1 • large round pouffe • ø 540 mm	 	1449	1509	1661	1735	1811	2112	2261
MVOS200000	Profim VANCOUVER OTO VOS2 • small square pouffe • 410 x 410 mm	 	1356	1413	1553	1623	1694	1976	2118
MVOS100000	Profim VANCOUVER OTO VOS1 • large square pouffe • 540 x 540 mm	 	1647	1716	1888	1974	2060	2403	2574

Accessories/Options/Surcharges:

7TATO002	Table top milky tempered glass (Only for: VOR1, VOR2)	674
7TATO002	Table top milky tempered glass (Only for: VOS1, VOS2)	788
7ELEC004	Mediaport - electrical outlet 230V and USB-C (Only for: VOS1, VOS2)	1901
7QUEL006	Quilting - outer surface (Q7)	738

0 price group: Evo

1 price group: Cura, Tonal, Xtreme

2 price group: Select

3 price group: Capture, Oceanic, Step, Synergy

4 price group: Steelcut 3, Steelcut Trio 3

6 price group: Paloma

Glides

Standard:

- hard glides - for soft floors.

Option:

- felt glides - for hard floors.

When ordering please clearly indicate the chosen option.

Table top G1 - lead time 20-30 working days.

Quilting - extra charge to all price groups, lead time 30-40 working days.







Profim WALL IN

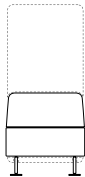

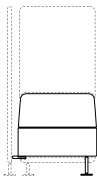
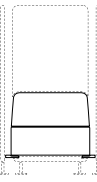
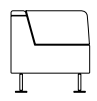
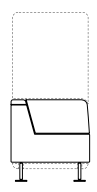
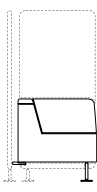
Tomek Rygalik, Studio Rygalik

- Walls enabling the division of the interior and the introduction of distance
- Possibility to choose upholstery colour
- Legs finished with aesthetic plates, available in three colours
- The mediaport is a complementary element

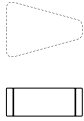
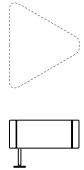
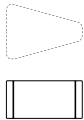
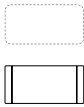
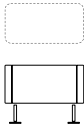
Item no	Base model +	Price Group (PG)	Price Group						Price
			0	①	②	③	④	⑤	
MWA1000000	Profim WALL IN 10 • pouffe • frame: black / MetallicPro		3 149	3 280	3 608	3 772	3 937	4 593	4 921
MWA1100000	Profim WALL IN 11 • pouffe to be connected with 1 partition wall • frame: black / MetallicPro		3 149	3 280	3 608	3 772	3 937	4 593	4 921
MWA1200000	Profim WALL IN 12 • pouffe to be connected with 2 partition walls • frame: black / MetallicPro		3 255	3 391	3 729	3 900	4 068	4 746	5 085
MWA1300000	Profim WALL IN 13 • pouffe to be connected with 3 partition walls • frame: black / MetallicPro		3 255	3 391	3 729	3 900	4 068	4 746	5 085
MWA2000000	Profim WALL IN 20 • armchair • frame: black / MetallicPro		4 119	4 290	4 718	4 933	5 148	6 005	6 436
MWA2100000	Profim WALL IN 21 • armchair to be connected with 1 partition wall • frame: black / MetallicPro		4 119	4 290	4 718	4 933	5 148	6 005	6 436

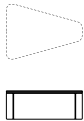
Item no	Base model +	Price Group (PG)	Price Group						Price
			0	①	②	③	④	⑤	
MWA2200000	Profim WALL IN 22 • armchair to be connected with 2 partition walls • frame: black / MetallicPro		4 224	4 400	4 841	5 061	5 281	6 162	6 601
MWA2300000	Profim WALL IN 23 • armchair to be connected with 3 partition walls • frame: black / MetallicPro		4 224	4 400	4 841	5 061	5 281	6 162	6 601
MWA3000000	Profim WALL IN 30 • corner armchair • frame: black / MetallicPro		4 702	4 898	5 390	5 635	5 880	6 858	7 349
MWA3100000	Profim WALL IN 31 • corner armchair to be connected with 1 partition wall • frame: black / MetallicPro		4 702	4 898	5 390	5 635	5 880	6 858	7 349
MWA3200000	Profim WALL IN 32 • corner armchair to be connected with 2 partition walls • frame: black / MetallicPro		4 809	5 010	5 509	5 760	6 013	7 014	7 515
MWAW110000	Profim WALL IN W11 • single partition wall to be connected with 1 seat • frame: black / MetallicPro		2 098	2 186	2 406	2 513	2 623	3 062	4 645
MWAW120000	Profim WALL IN W12 • single partition wall to be connected with 2 seats • frame: black / MetallicPro		2 098	2 186	2 406	2 513	2 623	3 062	4 645

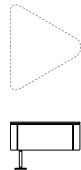
Item no	Base model +	Price Group (PG)	Price Group						Price
			0	①	②	③	④	⑤	
MWAC100000	Profim WALL IN C1 • pouffe • 30°connector		1925	2007	2208	2308	2408	2810	3009
MWAC200000	Profim WALL IN C2 • pouffe • 60°connector • frame: black / MetallicPro		2484	2587	2846	2976	3106	3623	3882
MWAP100000	Profim WALL IN P1 • pouffe • 30° armrest		2072	2159	2375	2482	2589	3023	3238
MWAP300000	Profim WALL IN P3 • pouffe • rectangular armrest		1874	1952	2146	2245	2341	2731	2928
MWAP400000	Profim WALL IN P4 • pouffe • rectangular armrest on legs • frame: black / MetallicPro		2499	2603	2861	2992	3123	3644	3902
MWAB000000	Profim WALL IN B • square table • frame: black / MetallicPro		3721	3875	4262	4456	4650	5425	5814
MWAB100000	Profim WALL IN B1 • table • 30°connector		4904	5108	5616	5874	6130	7149	7661

Item no	Base model +	Price Group (PG)	Price Group						Price
			0	①	②	③	④	⑤	
MWAB200000	Profim WALL IN B2 • table • 60°connector • frame: black / MetallicPro		3 827	3 985	4 385	4 585	4 783	5 579	5 979
MWABW10000	Profim WALL IN BW1 • square table to be connected with 1 partition wall • frame: black / MetallicPro		4 904	5 108	5 616	5 874	6 130	7 149	7 661
MWABW20000	Profim WALL IN BW2 • square table to be connected with 2 partition walls • frame: black / MetallicPro		3 721	3 875	4 262	4 456	4 650	5 425	5 814

Accessories/Options/Surcharges:

	Table top HPL (Only for: B, BW1, BW2)	1 372
	Table top HPL (Only for: B1)	1 146
	Table top HPL (Only for: B2)	1 599
7JIRO001	Possibility of joining in rows	33
7ELEC004	Mediaport - electrical outlet 230V and USB-C (Only for: 10, 11, 12, 13, 20, 21, 22, 23, 30, 31, 32)	1 933
7QUEL004	Quilting - inner surface (Q6) (Only for: 10, 11, 12, 13, C2)	398
7QUEL004	Quilting - inner surface (Q6) (Only for: 20, 21, 22, 23)	488
7QUEL004	Quilting - inner surface (Q6) (Only for: 30, 31, 32)	544
7QUEL004	Quilting - inner surface (Q6) (Only for: C1, P1, P3, P4)	285

1 price group: Cura, Tonal, Xtreme

2 price group: Select

3 price group: Capture, Oceanic, Step, Synergy

4 price group: Steelcut 3, Steelcut Trio 3

6 price group: Paloma

Glides

Standard:

- metal glides - for soft floors.

Option:

- felt glides - for hard floors.

When ordering please clearly indicate the chosen option.

Model P4 (on legs) allows the completion of any system.

Glides and linking parts for partition walls are provided with the seat to be connected with the partition wall.

Wall In W11/W12 models never occur as freestanding elements.

Table top G1 - lead time 20-30 working days.

Colours of HPL (LW): White (LW01), Light Grey (LW03); Grey (LW04), Black (LW02), Navy Blue (LW06), Light Burgundy (LW07) - lead time 20-30 working days.

Quilting - extra charge to all price groups, lead time 30-40 working days.









Tables







Coat stands





Accessories

Profim ALLROUND

- Table top in Laminate and Linoleum (24 mm)
- Table edge band will match table top colour as standard. Optionally choose black, white or grey table edge band to any table top colour within our rangewithout extra charge.

Item no	Base model +	Price Group (PG)	①	②	Price
5180-30	Profim ALLROUND 5180-30 (E) <ul style="list-style-type: none"> • Tables, height 73/90 cm • 80 x 80 cm with column frame base with 4 star footbase 		3 783	4 917	
5180-10	Profim ALLROUND 5180-10 (E) <ul style="list-style-type: none"> • Table, height 73/90 cm • 180 x 90 cm with T frame • Distance between legs 110 cm 		6 312	8 205	
5180-22	Profim ALLROUND 5180-22 (S) <ul style="list-style-type: none"> • Table, height 73/90 cm • 180 x 80 cm with T frame • Distance between table legs 110 cm 		5 995	7 793	
5180-24	Profim ALLROUND 5180-24 (E) <ul style="list-style-type: none"> • Table, height 73/90 cm • 160 x 80 cm with T frame • Distance between table legs 110 cm 		5 701	7 411	
5180-25	Profim ALLROUND 5180-25 (S) <ul style="list-style-type: none"> • Table, height 73/90 cm • 140 x 80 cm with T frame • Distance between table legs 80 cm • Weight approx. 24.5 kg Lam. 		5 619	7 306	
5180-27	Profim ALLROUND 5180-27 (S) <ul style="list-style-type: none"> • Table, height 73/90 cm • 120 x 80 cm with T frame • Distance between table legs 80 cm 		5 438	7 070	

Item no	Base model +	Price Group (PG)	①	②	Price
5180-36	Profim ALLROUND 5180-36 (E) <ul style="list-style-type: none"> • Table, height 73/90 cm • 180 x 70 cm with T frame • Distance between table legs 110 cm 		5 680	7 384	
5180-38	Profim ALLROUND 5180-38 (S) <ul style="list-style-type: none"> • Table, height 73/90 cm • 140 x 70 cm with T frame • Distance between table legs 80 cm 		5 492	7 141	
5180-39	Profim ALLROUND 5180-39 (S) <ul style="list-style-type: none"> • Table, height 73/90 cm • 120 x 70 cm with T frame • Distance between table legs 80 cm 		5 189	6 746	
5182-10	Profim ALLROUND 5182-10 (E) <ul style="list-style-type: none"> • Round table with frame base, height 50/73 cm • Ø60 cm - 4 star footbase 		3 940	5 123	
5182-102	Profim ALLROUND 5182-102 (E) <ul style="list-style-type: none"> • High table, height 90/110 cm • Ø60 cm - 4 star footbase 		4 085	5 311	
5182-15	Profim ALLROUND 5182-15 (S) <ul style="list-style-type: none"> • Round table with frame base, height 50/73 cm • Ø70 cm - 4 star footbase 		4 141	5 383	
5182-152	Profim ALLROUND 5182-152 (E) <ul style="list-style-type: none"> • High table, height 90/110 cm • Ø70 cm - 4 star footbase 		4 287	5 574	

Item no	Base model +	Price Group (PG)	①	②	Price
5182-20	Profim ALLROUND 5182-20 (E) • Round table with frame base, height 50/73 cm • Ø80 cm - 4 star footbase		4 389	5 705	
5182-202	Profim ALLROUND 5182-202 (E) • High table, height 90/110 cm • Ø80 cm - 4 star footbase		4 532	5 892	
5182-25	Profim ALLROUND 5182-25 (E) • Round table with frame base, height 50/73 cm • Ø100 cm - 5 star footbase		5 121	6 656	
5182-30	Profim ALLROUND 5182-30 (E) • Round table with frame base, height 50/73 cm • Ø120 cm - 5 star footbase		5 721	7 437	

Accessories/Options/Surcharges:

RS091003	Linking device with screws, not mounted, see below. Available for rectangular table w/ straight edged table top	140
----------	---	-----

1. Laminate on chipboard

2. Linoleum on chipboard

Height: 50/73/90/110 cm

Profim Allround table tops (rectangular and squared shapes) can be made available with MDF table core, chamfered edges of 20 degr and with a 10 mm black, white or grey edge band and black paint

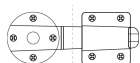

RS091003

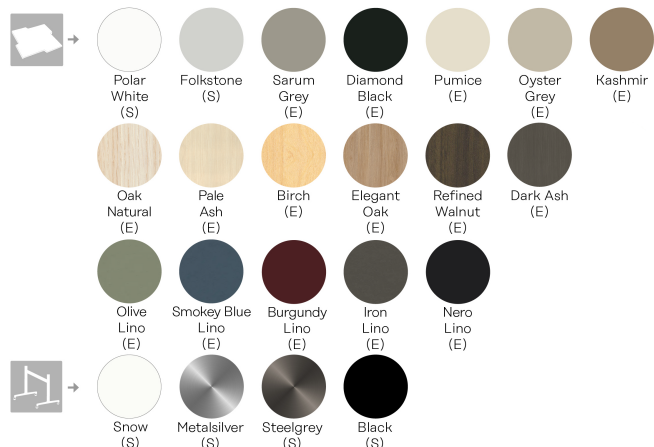

S=Standard Collection – normal production time 20-30 working days. Applicable when table top and base are standard (S).

E=Extended Collection – normal production time 30-35 working days (Linoleum: 35 working days). Applicable when any or all component options

selected are extended (E).





For larger orders, please contact Customer Service for delivery details.

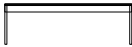

Profim CHIC COFFEE TABLE

Christophe Pillet

- A wide range of options for the tabletop finish: glass and wooden
- Possibility to use transparent glides in coffee tables

Item no	Base model +	Price Group (PG)	①	②	③	Price
MPHCS30000	Profim CHIC TABLE CS30 • coffee table • square • high • 450 x 450 x 560 mm • Frames colours: MetallicPro; Black RAL 9005; White RAL 9016; Deep Green RAL 6004; Navy Blue RAL 5003; Burgundy RAL 3005; Salvia/Green RAL 6021, Blue RAL 5014; Terracota RAL 3012		2 630	2 463	2 630	
MPHCS40000	Profim CHIC TABLE CS40 • coffee table • square • low • 800 x 800 x 250 mm • Frames colours: MetallicPro; Black RAL 9005; White RAL 9016; Deep Green RAL 6004; Navy Blue RAL 5003; Burgundy RAL 3005; Salvia/Green RAL 6021, Blue RAL 5014; Terracota RAL 3012		3 834	3 570	3 834	
MPHCR40000	Profim CHIC TABLE CR40 • coffee table • round • low • Ø 800 mm • Frames colours: MetallicPro; Black RAL 9005; White RAL 9016; Deep Green RAL 6004; Navy Blue RAL 5003; Burgundy RAL 3005; Salvia/Green RAL 6021, Blue RAL 5014; Terracota RAL 3012		3 515	3 266	3 515	
MPHCS3000F	Profim CHIC TABLE FRAME CS30 • table's frame • square • 450 x 450 x 560 mm • Frames colours: MetallicPro; Black RAL 9005; White RAL 9016; Deep Green RAL 6004; Navy Blue RAL 5003; Burgundy RAL 3005; Salvia/Green RAL 6021, Blue RAL 5014; Terracota RAL 3012					1 533
MPHCS4000F	Profim CHIC TABLE FRAME CS40 • table's frame • square • 800 x 800 x 250 mm • Frames colours: MetallicPro; Black RAL 9005; White RAL 9016; Deep Green RAL 6004; Navy Blue RAL 5003; Burgundy RAL 3005; Salvia/Green RAL 6021, Blue RAL 5014; Terracota RAL 3012					1 847

Item no	Base model +	Price Group (PG)	①	②	③	Price
MPHCR4000F	Profim CHIC TABLE FRAME CR40 • table's frame • Ø 800 mm • height 250 mm • Frames colours: MetallicPro; Black RAL 9005; White RAL 9016; Deep Green RAL 6004; Navy Blue RAL 5003; Burgundy RAL 3005; Salvia/Green RAL 6021, Blue RAL 5014; Terracota RAL 3012					1560

Accessories/Options/Surcharges:

7COPR003	Frames colours: Lightgrey; Grey					148
7COPR006	Frame colour: Gold					511

1. Veneers
2. Tempered glass (G1)
3. Tempered glass (G2/ G3/ G4)

Metal: MetallicPro; Black RAL 9005; White RAL 9016; Deep Green RAL 6004; Navy Blue RAL 5003; Burgundy RAL 3005; Salvia/Green RAL 6021, Blue RAL 5014; Terracota RAL 3012

Tempered glass: G1 (milky)

Tempered glass: G2 (black), G3 (RAL 7044/taupe), G4 (RAL 7042/grey)

Natural veneers: Ash (NA), Beech (NB), Oak (NO), Walnut (NW)

Natural colored veneers (ash): White (CNA01), Black (CNA02), Dark green (CNA05), Navy blue (CNA06), Burgundy (CNA07)

Glides: transparent, universal.

Option of mixing colours table top and frames.

Glass table top - lead time 20-30 working days.

Colours of natural modified veneers (HM): HM10 (bleached oak), HM11 (classic oak), HM12 (cardinal oak), HM20 (venge classic) - lead time 20-30 working days.

Frame is dedicated for assembly table tops made only from chipboard, plywood or wood. Self-assembly is not possible in case of glass and ceramics table tops.

Maximum parameters of the table top:

CR40 - Ø 800 mm, weight 14 kg,



CS40 - 800 x 800 mm, weight 18 kg,



CS30 - 450 x 450 mm, weight 11 kg.

Profim CHIC RESTAURANT TABLE

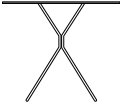
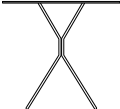
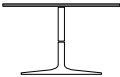
Christophe Pillet

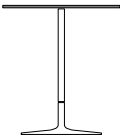
- A wide range of options for the tabletop finish: glass, wooden
- Several heights and types of bases offer many arrangement variants

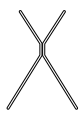
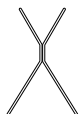
Item no	Base model +	Price Group (PG)	①	②	③	Price
MPHRH30000	Profim CHIC RESTAURANT TABLE RH30 <ul style="list-style-type: none"> • medium table • round Ø 800 mm • height 660 mm • 4-legged • frame: MetallicPro; Black RAL 9005; White RAL 9016; Deep Green RAL 6004; Navy Blue RAL 5003; Burgundy RAL 3005; Salvia/Green RAL 6021, Blue RAL 5014; Terracota RAL 3012 		4 249	3 267	3 458	
MPHRH20000	Profim CHIC RESTAURANT TABLE RH20 <ul style="list-style-type: none"> • medium table • round Ø 800 mm • height 740 mm • 4-legged • frame: MetallicPro; Black RAL 9005; White RAL 9016; Deep Green RAL 6004; Navy Blue RAL 5003; Burgundy RAL 3005; Salvia/Green RAL 6021, Blue RAL 5014; Terracota RAL 3012 		4 249	3 267	3 458	
MPHRR40000	Profim CHIC RESTAURANT TABLE RR40 <ul style="list-style-type: none"> • restaurant table • round Ø 800 mm • height 480 mm • round base • frame: MetallicPro; Black RAL 9005; White RAL 9016; Deep Green RAL 6004; Navy Blue RAL 5003; Burgundy RAL 3005; Salvia/Green RAL 6021, Blue RAL 5014; Terracota RAL 3012 		4 898			
MPHRR20000	Profim CHIC RESTAURANT TABLE RR20 <ul style="list-style-type: none"> • restaurant table • round Ø 800 mm • height 740 mm • round base • frame: MetallicPro; Black RAL 9005; White RAL 9016; Deep Green RAL 6004; Navy Blue RAL 5003; Burgundy RAL 3005; Salvia/Green RAL 6021, Blue RAL 5014; Terracota RAL 3012 		4 983			
MPHRR10000	Profim CHIC RESTAURANT TABLE RR10 <ul style="list-style-type: none"> • restaurant table • round Ø 800 mm • height 1100 mm • round base • frame: MetallicPro; Black RAL 9005; White RAL 9016; Deep Green RAL 6004; Navy Blue RAL 5003; Burgundy RAL 3005; Salvia/Green RAL 6021, Blue RAL 5014; Terracota RAL 3012 		5 024			

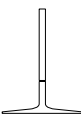
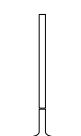
Item no	Base model +	Price Group (PG)	①	②	③	Price
MPHRH3000F	Profim CHIC RESTAURANT TABLE RH30 FRAME <ul style="list-style-type: none"> table's frame height 660 mm frame: MetallicPro; Black RAL 9005; White RAL 9016; Deep Green RAL 6004; Navy Blue RAL 5003; Burgundy RAL 3005; Salvia/Green RAL 6021, Blue RAL 5014; Terracota RAL 3012 					1631
MPHRH2000F	Profim CHIC RESTAURANT TABLE RH20 FRAME <ul style="list-style-type: none"> table's frame height 740 mm frame: MetallicPro; Black RAL 9005; White RAL 9016; Deep Green RAL 6004; Navy Blue RAL 5003; Burgundy RAL 3005; Salvia/Green RAL 6021, Blue RAL 5014; Terracota RAL 3012 					1631
MPHRR4000F	Profim CHIC RESTAURANT TABLE RR40 FRAME <ul style="list-style-type: none"> table's frame height 480 mm round base frame: MetallicPro; Black RAL 9005; White RAL 9016; Deep Green RAL 6004; Navy Blue RAL 5003; Burgundy RAL 3005; Salvia/Green RAL 6021, Blue RAL 5014; Terracota RAL 3012 					2291
MPHRR2000F	Profim CHIC RESTAURANT TABLE RR20 FRAME <ul style="list-style-type: none"> table's frame height 740 mm round base frame: MetallicPro; Black RAL 9005; White RAL 9016; Deep Green RAL 6004; Navy Blue RAL 5003; Burgundy RAL 3005; Salvia/Green RAL 6021, Blue RAL 5014; Terracota RAL 3012 					2363
MPHRR1000F	Profim CHIC RESTAURANT TABLE RR10 FRAME <ul style="list-style-type: none"> table's frame height 1100 mm round base frame: MetallicPro; Black RAL 9005; White RAL 9016; Deep Green RAL 6004; Navy Blue RAL 5003; Burgundy RAL 3005; Salvia/Green RAL 6021, Blue RAL 5014; Terracota RAL 3012 					2435
Accessories/Options/Surcharges:						
7COPR003	Frames colours: Lightgrey; Grey					148
7COPR006	Frame colour: Gold (Only for: RH20, RH20 FRAME, RH30, RH30 FRAME)					511
7COPR006	Frame colour: Gold (Only for: RR10, RR10 FRAME, RR20, RR20 FRAME, RR40, RR40 FRAME)					473

1. Natural veneers: Ash (NA), Beech (NB), Oak (NO), Walnut (NW)

Natural colored veneers (ash): White (CNA01), Black (CNA02), Dark green (CNA05), Navy blue (CNA06), Burgundy (CNA07)

2. Tempered glass: G1 (milky)

3. Tempered glass: G2 (black), G3 (RAL 7044/taupe), G4 (RAL 7042/grey)

Glides: teflon glides - universal.

Option of mixing colours table top and frames.

Glass table top - lead time 20-30 working days.

Iron cast base in Tables RR always black.

Natural veneers - lead time 20-30 working days.

Frame in Tables RR is dedicated for assembly table tops made only from chipboard, plywood or wood. Self-assembly is not possible in case of glass and ceramics table tops.





Maximum parameters of the table top:





RH - Ø 800 mm, weight 7 kg,

RR - Ø 800 mm, weight 24 kg.

Profim EMINENT

- Ø38 mm tubular table leg in various colours. See below Accessories/options. Incl. levelling feet (up to 17 mm on all legs)
- Table tops in various colours, see below Accessories/options.
- Table edge band will match table top colour as standard. Optionally choose black, white or grey table edge band to any table top colour within our range without extra charge.
- Table suspension brackets for several tables available for Profim Ana and Noor (except 6080/85). Cannot be attached to round tables

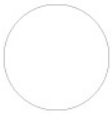
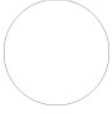
Item no	Base model +	Price Group (PG)	①	②	Price
4590-22	Profim EMINENT 4590-22 (S) <ul style="list-style-type: none"> • 180 x 80 cm • Distance between the table legs 164 cm • Weight appr 33.2 kg Lam. 		4 947	6 431	
4590-24	Profim EMINENT 4590-24 (S) <ul style="list-style-type: none"> • 160 x 80 cm • Distance between the table legs 144 cm • Weight appr 29.8 kg Lam. 		4 572	5 944	
4590-25	Profim EMINENT 4590-25 (S) <ul style="list-style-type: none"> • 140 x 80 cm • Distance between the table legs 124 cm • Weight appr 27.3 kg Lam. 		4 254	5 531	
4590-27	Profim EMINENT 4590-27 (S) <ul style="list-style-type: none"> • 120 x 80 cm • Distance between the table legs 104 cm • Weight appr 24.2 kg Lam. 		4 052	5 268	
4590-30	Profim EMINENT 4590-30 (E) <ul style="list-style-type: none"> • 80 x 80 cm • Distance between the table legs 64 cm • Weight appr 18.7 kg Lam. 		3 515	4 570	

Item no	Base model +	Price Group (PG)	①	②	Price
4590-38	Profim EMINENT 4590-38 (S) <ul style="list-style-type: none"> • 140 x 70 cm • Distance between the table legs 124 cm • Weight appr 25.2 kg Lam. 		4 180	5 434	
4590-52	Profim EMINENT 4590-52 (E) <ul style="list-style-type: none"> • 140 x 60 cm • Distance between the table legs 124 cm • Weight appr 23 kg Lam. 		4 328	5 627	
4590-54	Profim EMINENT 4590-54 (S) <ul style="list-style-type: none"> • 120 x 60 cm • Distance between the table legs 104 cm • Weight appr 20.4 kg Lam 		3 668	4 768	
4592-30	Profim EMINENT 4592-30 (E) <ul style="list-style-type: none"> • Ø120 cm with 4 legs • Distance between the table legs 60 cm 		5 236	6 808	
4592-50	Profim EMINENT 4592-50 (E) <ul style="list-style-type: none"> • Ø160 cm with 4 legs • Distance between the table legs 91 cm 				
4593-15	Profim EMINENT 4593-15 (E) <ul style="list-style-type: none"> • Trapezium 140 x 70 x 70 x 70, depth 60 cm • Distance between the table legs 116/53/60 cm 		4 351	5 656	
Accessories/Options/Surcharges:					
M30410	Bracket for 1 chair. Noor**				348
M130355	Bracket for 2 chairs. Ana**				1 100
M130360	Bracket for 2 chairs. Ana (One chair per table side)**				1 100

Accessories/Options/Surcharges:

M09502

Castors Eminent 4 pcs. Lockable

1 372

1. Laminate on chipboard

2. Linoleum on chipboard

Table top in Laminate and Linoleum (24 mm)

Height approx. 73.5 cm. Table leg adjustment screw on legs

** See separate page "Table/chair suspension bracket system" for details

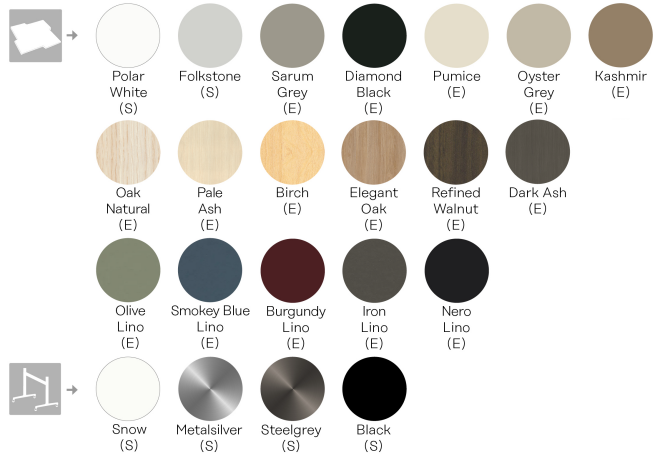

S=Standard Collection - normal production time 20-30 working days. Applicable when table top and base are standard (S).

E=Extended Collection - normal production time 30-35 working days (Linoleum: 35 working days). Applicable when any or all component options selected are extended (E).

For larger orders, please contact Customer Service for delivery details.

Table/chair suspension bracket system for Eminent table

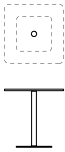
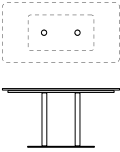
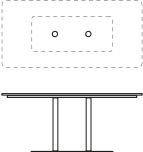

Table size (Length x width)	Width between legs (width chair)	Noor 6050/6055* (M30410 Bracket)	Noor 6060/6065* (M30410 Bracket)	Noor 6070/6075* (M30410 Bracket)	Ana	Com H/V (M30403 Bracket)
1200x600	1046x(446)	1	1	1	1 (M130350)	1 or 2
800x800	646x(646)	1 on both sides	1 on both sides	1 on both sides	2 on same side (M130355)	1 on both sides
1200x800	1046	1 on both sides	1 on both sides	1 or 2 on both sides	2 (1 on both sides) (M130360)	1 or 2 on both sides
1400x600	1246	1 or 2 on one side	1 or 2 on one side	1 or 2 on one side	4 (2 on both sides) (M130365)	1 or 2
1400x700	1246	1 or 2 on both sides	1 or 2 on both sides	1 or 2 on both sides	-	1 or 2 on both sides
1400x800	1246	1 or 2 on both sides	1 or 2 on both sides	1 or 2 on both sides	-	1 or 2 on both sides
1600x800	1446	1 or 2 on both sides	1 or 2 on both sides	1 or 2 on both sides	-	1 or 2 on both sides
1800x800	1646	1, 2 or 3 on both sides	1 or 2 on both sides	1 or 2 on both sides	6 (3 on both sides) (M130370)	1, 2 or 3 on both sides





* Valid for unupholstered chair, upholstered Seat (S), upholstered Seat and Back (SB) and Fully upholstered (F) variants. Table suspension bracket not applicable for Noor 6080/6085

Profim REVO TABLES

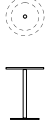
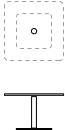
Pearson Lloyd

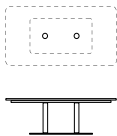
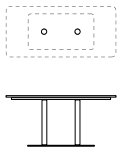
- tables and table frames of different length and height and shape
- designed with comfort in mind
- versatile and lightweight design
- various color palette of table tops and frames

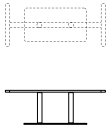
Item no	Base model +	Price Group (PG)	①	②	Price
MRVT750000	Profim REVO T75 • table 750 x 750 mm • height 740 mm • square, flat base		5 640	6 000	
MRVT150000	Profim REVO T150 • table 1500 x 750 mm • height 740 mm • rectangular, flat base		10 561	11 055	
MRVT180000	Profim REVO T180 • table 1800 x 850 mm • height 740 mm • rectangular, flat base		12 157	13 246	
MRVLS65000	Profim REVO LS65 • table 650 x 350 mm • height 665 mm • rectangular, flat base		3 787	4 022	
MRVLR48000	Profim REVO LR48 • table round Ø 480 mm • height 665 mm • round base, flat base		3 787	4 022	
MRVC750000	Profim REVO C75 • low table 750 x 750 mm • height 450 mm • square, flat base		5 461	5 831	

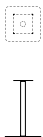
Item no	Base model +	Price Group (PG)	①	②	Price
MRVC150000	Profim REVO C150 <ul style="list-style-type: none"> • low table 1500 x 750 mm • height 450 mm • rectangular, flat base 		10 202	10 686	
MRVT140000	Profim REVO MT140 <ul style="list-style-type: none"> • medium table 1400 x 700 mm • height 650 mm • rectangular, flat base 		10 204	10 674	
MRVC75000F	Profim REVO FRAME C75 <ul style="list-style-type: none"> • table's frame • height 440 mm • square, flat base 				3 634
MRVC15000F	Profim REVO FRAME C150 <ul style="list-style-type: none"> • table's frame • height 440 mm • rectangular, flat base 				7 040
MRVLR4800F	Profim REVO FRAME LR48 <ul style="list-style-type: none"> • table's frame • height 655 mm • round base, flat base 				2 975
MRVLS6500F	Profim REVO FRAME LS65 <ul style="list-style-type: none"> • table's frame • height 655 mm • rectangular, flat base 				3 093
MRVT75000F	Profim REVO FRAME T75 <ul style="list-style-type: none"> • table's frame • height 730 mm • square, flat base 				3 926

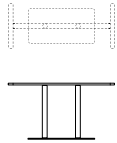
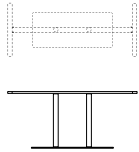
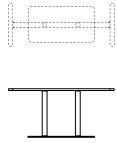
Item no	Base model +	Price Group (PG)	①	②	Price
MRVT15000F	Profim REVO FRAME T150 <ul style="list-style-type: none"> • table's frame • height 730 mm • rectangular, flat base 				7 689
MRVT18000F	Profim REVO TABLES FRAME T180 <ul style="list-style-type: none"> • table's frame • height 730 mm • rectangular, flat base 				8 728
MRVT14000F	Profim REVO FRAME MT140 <ul style="list-style-type: none"> • table's frame • height 640 mm • rectangular, flat base 				7 495

1. Natural veneers / Natural colored veneers (ash)Frame

2. HPL

MetallicPro; Black RAL 9005; White RAL 9016; Light Grey NCS S 2500 N; Grey NCS S 6500 N; Deep Green RAL 6004; Navy Blue RAL 5003; Burgundy RAL 3005; Salvia/Green RAL 6021, Blue RAL 5014; Terracota RAL 3012

Natural veneers

Ash (NA), Beech (NB), Oak (NO), Walnut (NW)

Natural colored veneers (ash)

White (CNA01), Black (CNA02), Dark green (CNA05), Navy blue (CNA06), Burgundy (CNA07)

HPL

White (LW01), Light Grey (LW03); Grey (LW04), Black (LW02), Navy Blue (LW06), Light Burgundy (LW07)

There is a possibility of any combination of the top and frame colors.

Natural veneers: Ash (NA); Beech (NB); Oak (NO); Orzech (NW) - delivery time 30 business days.

Natural colored veneers: delivery time 30 business days.

HPL worktops: delivery time 30 business days.

Frame in Revo Tables is dedicated for assembly table tops made only from chipboard, plywood or wood.

Maximum parameters of the table top:

C75- 750 x 750 mm, weight 4kg.

C150 - 1500 x 750 mm, weight 8 kg.

LR48 - Ø 480 mm, weight 1,5 kg.

LS65 - 350 x 650 mm, weight 2kg

T75 - 750 x 750 mm, weight 4kg.

T150 - 1500 x 750 mm, weight 8 kg.



T180 - 1800 x 850 mm, weight 11kg.



MT140 - 1400 x 700 mm, weight 7kg.

Profim STANDARD FOLDING TABLE

- Folding table - 100 mm height when collapsed (with 22 mm table top)
- Frame in various colours. See below Accessories/options.
- For table top colours, see below Accessories/options.
- Table top edge band will match table top as standard. Optionally choose black, white or grey table edge band to any table top colour within our range without extra charge.
- Table top in Laminate (24 mm)

Item no	Base model +	Price Group (PG)	① Price
4680-10	Profim STANDARD FOLDING TABLE 4680-10 (E) <ul style="list-style-type: none"> • 180 x 90 cm • Distance between the table legs 103 cm • Weight appr 30.9 kg Lam. 		5 000
4680-15	Profim STANDARD FOLDING TABLE 4680-15 (S) <ul style="list-style-type: none"> • 120 x 90 cm • Distance between the table legs 103 cm • Weight appr 22.6 kg Lam. 		4 049
4680-22	Profim STANDARD FOLDING TABLE 4680-22 (S) <ul style="list-style-type: none"> • 180 x 80 cm • Distance between the table legs 103 cm • Weight appr 28.1 kg Lam. 		4 614
4680-24	Profim STANDARD FOLDING TABLE 4680-24 (S) <ul style="list-style-type: none"> • 160 x 80 cm • Distance between the table legs 103 cm • Weight appr 25.7 kg Lam. 		4 342
4680-25	Profim STANDARD FOLDING TABLE 4680-25 (S) <ul style="list-style-type: none"> • 140 x 80 cm • Distance between the table legs 103 cm • Weight appr 23.2 kg Lam. 		4 057

Item no	Base model +	Price Group (PG)	① Price
4680-27	Profim STANDARD FOLDING TABLE 4680-27 (S) <ul style="list-style-type: none"> • 120 x 80 cm • Distance between the table legs 103 cm • Weight appr 20.8 kg Lam. 		3 729
4680-36	Profim STANDARD FOLDING TABLE 4680-36 (E) <ul style="list-style-type: none"> • 180 x 70 cm • Distance between the table legs 103 cm • Weight appr 25.4 kg Lam. 		4 112
4680-38	Profim STANDARD FOLDING TABLE 4680-38 (S) <ul style="list-style-type: none"> • 140 x 70 cm • Distance between the table legs 103 cm • Weight appr 21.1 kg Lam. 		3 665
4680-39	Profim STANDARD FOLDING TABLE 4680-39 (S) <ul style="list-style-type: none"> • 120 x 70 cm • Distance between the table legs 103 cm • Weight appr 18.9 kg Lam. 		3 520
4680-52	Profim STANDARD FOLDING TABLE 4680-52 (S) <ul style="list-style-type: none"> • 140 x 60 cm • Distance between the table legs 103 cm • Weight appr 18.9 kg Lam. 		3 697
4680-54	Profim STANDARD FOLDING TABLE 4680-54 (S) <ul style="list-style-type: none"> • 120 x 60 cm • Distance between the table legs 103 cm • Weight appr 17.1 kg Lam. 		3 316

Item no	Base model +	Price Group (PG)	① Price
4680-58	Profim STANDARD FOLDING TABLE 4680-58 (S) <ul style="list-style-type: none"> • Exam table 90 x 60 cm • Distance between the table legs 75 cm • Weight appr 14.3 kg Lam. 		2812
4680-90	Profim STANDARD FOLDING TABLE 4680-90 (S) <ul style="list-style-type: none"> • 120 x 45 cm • Distance between the table legs 103 cm • Weight appr 14.3 kg Lam. 		2934
4681-45	Profim STANDARD FOLDING TABLE 4681-45 (E) <ul style="list-style-type: none"> • 1/2 circle with folding frame, Ø160 cm • Distance between the table legs 74 cm 		4891
4688-52	Profim STANDARD FOLDING TABLE 4688-52 (E) <ul style="list-style-type: none"> • L-frame • 140 x 60 cm • Distance between the table legs 103 cm • Weight appr 18.9 kg Lam. 		3697
4688-54	Profim STANDARD FOLDING TABLE 4688-54 (E) <ul style="list-style-type: none"> • L-frame • 120 x 60 cm • Distance between the table legs 103 cm • Weight appr 17.1 kg Lam. 		3331
4688-90	Profim STANDARD FOLDING TABLE 4688-90 (E) <ul style="list-style-type: none"> • L-frame • 120 x 45 cm • Distance between the table legs 103 cm • Weight appr 14.3 kg Lam. 		2934

Accessories/Options/Surcharges:

RS091003	Linking device with screws, not mounted, see below. Available for rectangular table w/ straight edged table top	140
RS092064	Standard Folding table levelling screw	12
3211	Trolley 125 x 71 cm, (without drive bar and retainer for trolley), transport tables (7) standing or (12) lying down	7405

Accessories/Options/Surcharges:

3212	Trolley 200x71 cm (without drive bar and retainer for trolley), transport tables 13 Std. standing or 12 lying down	8 420
3213	Drive bar for trolley	3 210
3214	Retainer for trolley - requires 2 per trolley for transport of standing tables - price per unit	4 419

1. Laminate on chipboard

Height, approx: 74.5 cm

Trolley with frame. 3211 for transport of 5 upright Profm Standard folding tables. 3212 for transport of 13 upright Profim Standard folding tables. Both trolleys can hold 12 tables lying down

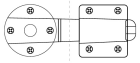

RS091003

S=Standard Collection - normal production time 20-30 working days. Applicable when table top and base are standard (S).

E=Extended Collection - normal production time 30-35 working days. Applicable when any or all component options selected are extended (E).



For larger orders, please contact Customer Service for delivery details.

Lightweight core on request.

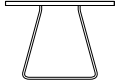
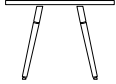
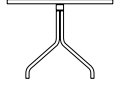

Profim TABLES

- SR model comes in four heights, in three colour variations of the base on a circular form
- SH model comes in three heights, four frame colours and a round top made of tempered milk glass
- SF model comes in two heights on a four-star polished aluminium base
- SV model is available on a metal wire frame with four colour variations and the SW model on wooden legs

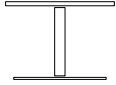
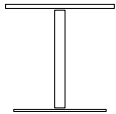
Item no	Base model +	Price Group (PG)	Tempered glass (G1)	Price
MQC400V000	Profim TABLES SV40 <ul style="list-style-type: none"> • table, round • Ø 600 • height 450 mm • wire frame • frame: black 			1 626
MQC400W000	Profim TABLES SW40 <ul style="list-style-type: none"> • table, round • Ø 600 • height 450 mm • wooden legs (Beech): H5, H6, H12 			2 749
MQC400H000	Profim TABLES SH40 <ul style="list-style-type: none"> • low table, round • Ø 600 • height 450 mm • metal legs • frame: black 			1 986
MQC300H000	Profim TABLES SH30 <ul style="list-style-type: none"> • medium table, round • Ø 600 • height 600 mm • metal legs • frame: black 			2 011
MQC400R000	Profim TABLES SR40 <ul style="list-style-type: none"> • low table, round • Ø 600 • height 450 mm • round base • base: black 			2 300
MQC300R000	Profim TABLES SR30 <ul style="list-style-type: none"> • medium table, round • Ø 600 • height 600 mm • round base • base: black 			2 315



Item no	Base model +	Price Group (PG)	Tempered glass (G1)	Price
MQC40H000F	Profim TABLES SH40 FRAME <ul style="list-style-type: none"> table's frame, low height 440 mm metal legs frame: black 			1 259
MQC30H000F	Profim TABLES SH30 FRAME <ul style="list-style-type: none"> table's frame, medium height 590 mm metal legs frame: black 			1 284
MQC40R000F	Profim TABLES SR40 FRAME <ul style="list-style-type: none"> table's frame, low height 440 mm round base base: black 			1 592
MQC30R000F	Profim TABLES SR30 FRAME <ul style="list-style-type: none"> table's frame, medium height 590 mm round base base: black 			1 616
Accessories/Options/Surcharges:				
	Oak wood - HO6, HO12, HO11 (Only for: SW40)			219
	Table top HPL (Only for: SH30, SR30, SH40, SR40)			1 146
7COPR002	Frames colours: MetallicPro, White RAL 9016, Deep Green RAL 6004, Navy Blue RAL 5003, Burgundy RAL 3005, Salvia/Green RAL 6021, Blue RAL 5014, Terracota RAL 3012 (Only for: SH30, SR30, SR30 FRAME, SH40, SR40, SV40, SR40 FRAME)			25
7COPR003	Frames colours: Lightgrey; Grey (Only for: SH30, SR30, SH30 FRAME, SR30 FRAME, SH40, SR40, SV40, SH40 FRAME, SR40 FRAME)			148

Table top: tempered glass: G1 (milky)

Colours of HPL White (LW01), Light Grey (LW03); Grey (LW04), Black (LW02), Navy Blue (LW06), Light Burgundy (LW07) - lead time 20-30 working days.



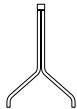

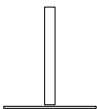
Frame in Tables SH is dedicated for assembly table tops made only from chipboard, plywood or wood. Self-assembly is not possible in case of glass table tops. Maximum parameters of the table top: Ø 600 mm.





Frame in Tables SR is dedicated for assembly table tops made only from chipboard, plywood or wood. Self-assembly is not possible in case of glass table tops. Maximum parameters of the table top: Ø 900 mm, weight 7,0 kg.

Profim U-CONNECT

Acer Design a/s, Justus Kolberg, Erik Simonsen

- Folding tables
- A smart mobile folding table with wheels and can nest together when lined up in the vertical position. The table top is anchored with a bracket in the upright position. The table top can be tipped along its long axis
- Table top edge band will match table top colour as standard. Optionally choose black, white or grey table edge band to any table top colour within our range without extra charge.
- Table top in Laminate or Linoleum (24 mm)

Item no	Base model +	Price Group (PG)	①	②	Price
3490-22	Profim U-CONNECT 3490-22 (S) <ul style="list-style-type: none"> • 180 x 80 cm • Distance between the table legs 163 cm • Weight appr 31.6 kg Lam. 		8 642	11 233	
3490-36	Profim U-CONNECT 3490-36 (S) <ul style="list-style-type: none"> • 180 x 70 cm • Distance between the table legs 163 cm • Weight appr 28.7 kg Lam. 		8 442	10 974	
3490-24	Profim U-CONNECT 3490-24 (S) <ul style="list-style-type: none"> • 160 x 80 cm • Distance between the table legs 143 cm • Weight appr 28.7 kg Lam. 		7 853	10 210	
3490-37	Profim U-CONNECT 3490-37 (S) <ul style="list-style-type: none"> • 160 x 70 cm • Distance between the table legs 143 cm • Weight appr 26.1 kg Lam. 		7 675	9 977	
3490-25	Profim U-CONNECT 3490-25 (S) <ul style="list-style-type: none"> • 140 x 80 cm • Distance between the table legs 123 cm • Weight appr 25.4 kg Lam. 		7 142	9 283	

Item no	Base model +	Price Group (PG)	①	②	Price
3490-38	Profim U-CONNECT 3490-38 (S) <ul style="list-style-type: none"> • 140 x 70 cm • Distance between the table legs 123 cm • Weight appr 23.2 kg Lam. 		6977	9070	
3490-52	Profim U-CONNECT 3490-52 (S) <ul style="list-style-type: none"> • 140 x 60 cm • Distance between the table legs 123 cm • Weight appr 21 kg Lam. 		6857	8915	
3490-27	Profim U-CONNECT 3490-27 (S) <ul style="list-style-type: none"> • 120 x 80 cm • Distance between the table legs 103 cm • Weight appr 22.6 kg Lam. 		6943	9026	
3490-39	Profim U-CONNECT 3490-39 (S) <ul style="list-style-type: none"> • 120 x 70 cm • Distance between the table legs 103 cm • Weight appr 21.6 kg Lam. 		6801	8842	
3490-54	Profim U-CONNECT 3490-54 (S) <ul style="list-style-type: none"> • 120 x 60 cm • Distance between the table legs 103 cm • Weight appr 18.5 kg Lam. 		6662	8662	
Accessories/Options/Surcharges:					
PHFILIP8	Additional price* for polished aluminium legs				1097

1. Laminate on chipboard
2. Linoleum on chipboard

Height 73.5 cm

Features Ø65 mm castors with soft rim and brake

Profim u-Connect table tops (rectangular and squared shapes) can be made available with MDF table core, chamfered edges of 20 degr and with a 10 mm black, white or grey edge band and black paint (see extra charge below)

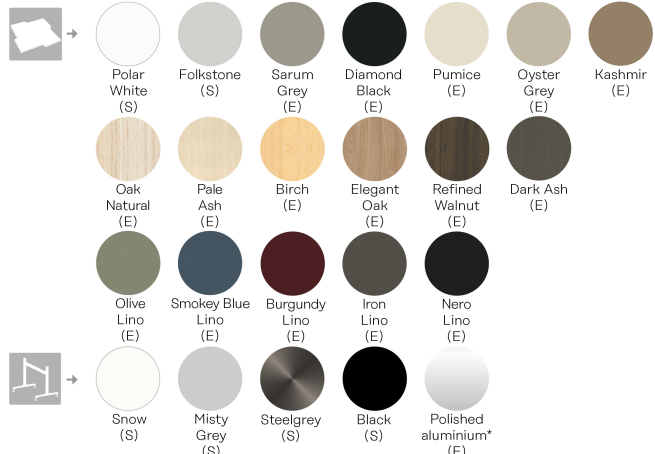
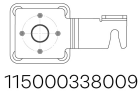
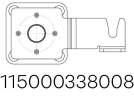

S=Standard Collection – normal production time 20-30 working days. Applicable when table top and base are standard (S).
 E=Extended Collection – normal production time 30-35 working days (Linoleum: 35 working days). Applicable when any or all component options selected are extended (E).

For larger orders, please contact Customer Service for delivery details.
 Lightweight core on request.



Profim SEVEN

Tomek Rygalik, Studio Rygalik

- Option of combining colours, it is possible to play with colours (hanger and hooks are available in different shades)

Item no	Base model +	Price Group (PG)	Coat hanger	Price
MSZ0000000	Profim SEVEN • coat hanger			1 559

Hard glides - for soft floors (set).



Colours of frame:

- Black RAL 9005
- MetallicPro
- White RAL 9016
- Lightgrey NCS S 2500-N
- Grey NCS S 6500-N
- Deep green RAL 6004
- Navy blue RAL 5003
- Burgundy RAL 3005
- Salvia/Green RAL 6021
- Blue RAL 5014
- Terracota RAL 3012
- Steelgray

It is possible to order hooks in different colour than the coat stand frame.

Profim CUSHION

- Two sizes
- Several types of fabric

Item no	Base model +	Price Group (PG)	①	②	③	④	Price
MCU3000000	Profim CUSHION CU30 • cushions with filling • 300 x 300 mm		307	487	508	761	
MCU4000000	Profim CUSHION CU40 • cushions with filling • 400 x 400 mm		360	526	547	887	

1 price group: Cura, Tonal, Xtreme

2 price group: Select

3 price group: Capture, Oceanic, Step, Synergy

4 price group: Steelcut 3, Steelcut Trio 3

Filling: silicon.

Weight:

CU30 - 0,15 kg,

CU40 - 0,25 kg.

Colour of pillowcase is always white.

Technical details

Type of packaging

Box sizes legend: A - 735x760x1115 C - 670x730x835 E - 670x730x1160 G - 815x720x515 I - 815x720x1315
 B - 735x760x1315 D - 670x730x955 F - 735x720x480 H - 815x720x1115

Product netto weight (Kg)	Assembled in foil	Assembled in Box			Semi knocked down			Fully knocked down			
	Possibility	Box size (mm)	Box weight (Kg)	Volume (m³)	Box size (mm)	Box weight (Kg)	Volume (m³)	Box size (mm)	Box weight (Kg)	Volume (m³)	
Accis^{Pro}											
150SFL	18	●	-	-	-	D	4.6	0.47	-	-	-
151SFL	18.5	●	-	-	-	D	4.6	0.47	-	-	-
Action											
100SFL / 105SFL	20.5	●	-	-	-	D	4.6	0.47	-	-	-
110SFL / 115SFL	21.5	●	-	-	-	E	4.6	0.47	-	-	-
LightUp											
230S / 230SL / 230SFL	17	●	A	4.2	0.62	C	4.5	0.41	F	4.1	0.25
250S / 250SL / 250SFL	16	●	A	4.2	0.62	C	4.5	0.41	F	4.1	0.25
230S / 230SL / 230SFL	17	●	A	4.2	0.62	C	4.5	0.41	-	-	-
250S / 250SL / 250SFL	16	●	A	4.2	0.62	C	4.5	0.41	-	-	-
330S	18.5	-	-	-	-	C	4.5	0.41	-	-	-
350S	17.5	-	-	-	-	C	4.5	0.41	-	-	-
Motto											
10S/10SL/10SFL	18.5	●	A	4.2	0.62	C	4.5	0.41	F	4.1	0.25
11S/11SL / 11SFL	19.5	●	A	4.2	0.62	D	4.6	0.47	-	-	-
MyTurn											
10S	22.5	●	I	7,05	0.77	-	-	-	-	-	-
10FZ	22	●	I	7,05	0.77	-	-	-	-	-	-
20S	21.5	●	H	6,5	0.65	-	-	-	-	-	-
20FZ	21	●	H	6,5	0.65	-	-	-	-	-	-
Playa											
11SL	21	●	A	4.2	0.62	D	4.6	0.47	G	4,65	0.30
12SL	19	●	B	4.6	0.73	E	4.6	0.47	-	-	-
Raya											
21S	16	●	A	4.2	0.62	C	4.5	0.41	F	4.1	0.25
23S	16	●	A	4.2	0.62	C	4.5	0.41	F	4.1	0.25
21SL	17.5	●	A	4.2	0.62	C	4.5	0.41	F	4.1	0.25
23SL	17.5	●	A	4.2	0.62	C	4.5	0.41	F	4.1	0.25

Type of packaging

Box sizes legend: A - 735x760x1115 C - 670x730x835 E - 670x730x1160 G - 815x720x515 I - 815x720x1315
 B - 735x760x1315 D - 670x730x955 F - 735x720x480 H - 815x720x1115

Product netto weight (Kg)	Assembled in foil	Assembled in Box			Semi knocked down			Fully knocked down			
	Possibility	Box size (mm)	Box weight (Kg)	Volume (m ³)	Box size (mm)	Box weight (Kg)	Volume (m ³)	Box size (mm)	Box weight (Kg)	Volume (m ³)	
Trillo^{Pro}											
20ST	11.5	-	-	-	-	-	-	F	4.1	0.25	
21ST	12	-	-	-	-	-	-	F	4.1	0.25	
20HST	12.5	-	-	-	-	-	-	G	4,65	0.30	
21HST	13	-	-	-	-	-	-	G	4,65	0.30	
30ST	14.5	-	-	-	-	-	-	G	4,65	0.30	
31ST	14	-	-	-	-	-	-	G	4,65	0.30	
Veris Net											
100SFL / 101SFL	16.5	●	A	4.2	0.62	D	4.6	0.47	-	-	-
110SFL / 111SFL	17.5	●	B	4.6	0.73	E	5	0.57	-	-	-
Violle											
130	20	●	A	4.2	0.62	C	4.5	0.41	-	-	-
131	20.5	●	B	4.6	0.73	D	4.6	0.47	-	-	-
150	19.5	●	A	4.2	0.62	C	4.5	0.41	-	-	-
151	20	●	B	4.6	0.73	D	4.6	0.47	-	-	-
Xenon											
10S	19.5	●	A	4.2	0.62	C	4.5	0.41	G	4,65	0.30
10SL / 10SFL	19.5	●	A	4.2	0.62	C	4.5	0.41	G	4,65	0.30
10S	19.5	●	A	4.2	0.62	C	4.5	0.41	-	-	-
10SL / 10SFL	19.5	●	A	4.2	0.62	C	4.5	0.41	-	-	-
11S	20.5	●	B	4.6	0.73	D	4.6	0.47	-	-	-
11SL / 11SFL	20.5	●	B	4.6	0.73	D	4.6	0.47	-	-	-
Xenon Net											
100S/101S	18.5	●	A	4.2	0.62	C	4.5	0.41	G	4,65	0.30
100SL / 101SL / 100SFL / 101SFL	18.5	●	A	4.2	0.62	C	4.5	0.41	G	4,65	0.30
100S/101S	18.5	●	A	4.2	0.62	C	4.5	0.41	-	-	-
100SL / 101SL / 100SFL / 101SFL	18.5	●	A	4.2	0.62	C	4.5	0.41	-	-	-
110S / 111S	19.5	●	B	4.6	0.73	D	4.6	0.47	-	-	-
110SL / 110SFL / 111SL / 111SFL	19.5	●	B	4.6	0.73	D	4.6	0.47	-	-	-

Type of packaging

Box type legend: A - 670x730x955, 3,2Kg, 0,47m³ B - 670x730x1160, 3,6Kg, 0,5m³

	Product netto weight (Kg)	1 pc	2 pcs	3 pcs	4 pcs	5 pcs	Box Info	Comments
		Box type	Box type	Box type	Box type	Box type		
Acos^{Pro}								
30H	10,5	A	-	-	-	-	1 pc/box A	
30V	12,5	A	B	-	-	-	1-2 pcs/box B	
Arca								
21V	8,5	A	-	-	-	-	1 pc/box A	
Ariz								
550CV	8	B	B	-	-	-	1-2 pcs/box B	
550V	6,5	A	A	B	B	B	1-2 pcs/box A 3-5 pcs/box B	
555CV	7,5	B	B	-	-	-	1-2 pcs/box B	
555V	6	A	A	B	B	B	1-2 pcs/box A 3-5 pcs/box B	
560CV	8,5	B	B	-	-	-	1-2 pcs/box B	
560V	7	A	A	B	B	B	1-2 pcs/box A 3-5 pcs/box B	
570CV	9	B	B	-	-	-	1-2 pcs/box B	
570V	7,5	A	A	B	B	B	1-2 pcs/box A 3-5 pcs/box B	
575CV	8	A	B	-	-	-	1-2 pcs/box B	
575V	6,5	A	A	B	B	B	1-2 pcs/box A 3-5 pcs/box B	
Bit								
550H	5,5	A	A	B	-	-	1-2 pcs/box A 3-3 pcs/box B	
550V	7,5	A	A	B	-	-	1-2 pcs/box A 3-3 pcs/box B	
555H	5,5	A	A	B	-	-	1-2 pcs/box A 3-3 pcs/box B	
555V	7,5	A	A	B	-	-	1-2 pcs/box A 3-3 pcs/box B	
560H	6,5	A	A	B	-	-	1-2 pcs/box A 3-3 pcs/box B	
560V	8	A	A	B	-	-	1-2 pcs/box A 3-3 pcs/box B	
570H	7	A	A	B	-	-	1-2 pcs/box A 3-3 pcs/box B	
570V	8,5	A	A	B	-	-	1-2 pcs/box A 3-3 pcs/box B	
575H	6,5	A	A	B	-	-	1-2 pcs/box A 3-3 pcs/box B	
575V	8	A	A	B	-	-	1-2 pcs/box A 3-3 pcs/box B	
580H	7	A	B	B	-	-	1-1 pc/box A 2-3 pcs/box B	
580V	9,5	A	B	B	-	-	1-1 pc/box A 2-3 pcs/box B	

Type of packaging

Box type legend: A - 670x730x955, 3,2Kg, 0,47m³ B - 670x730x1160, 3,6Kg, 0,5m³

	Product netto weight (Kg)	1 pc	2 pcs	3 pcs	4 pcs	5 pcs	Box Info	Comments
		Box type	Box type	Box type	Box type	Box type		
Com								
K12CV	7,5	B	-	-	-	-	1 pc/box B	
K12H	5,5	A	-	-	-	-	1 pc/box A	with writing table
K12H	5,5	A	A	B	B	B	1-2 pcs/box A 3-5 pcs/box B	without writing table
K12HC	7,5	A	-	-	-	-	1 pc/box A	
K12HF	7,5	A	-	-	-	-	1 pc/box A	
K12HS	7,5	A	-	-	-	-	1 pc/box A	
K12V	6,5	A	A	B	B	B	1-2 pcs/box A 3-5 pcs/box B	Cantliver V
K12V	6,5	A	A	B	-	-	1-2 pcs/box A 3-3 pcs/box B	Cantliver V1;V2
K22CV	8	B	-	-	-	-	1 pc/box B	
K22H	6	A	-	-	-	-	1 pc/box A	with writing table
K22H	6	A	A	B	B	B	1-2 pcs/box A 3-5 pcs/box B	without writing table
K22HC	8	A	-	-	-	-	1 pc/box A	
K22HF	8	A	-	-	-	-	1 pc/box A	
K22HS	8	A	-	-	-	-	1 pc/box A	
K22V	7	A	A	B	B	B	1-2 pcs/box A 3-5 pcs/box B	Cantliver V
K22V	7	A	A	B	B	B	1-2 pcs/box A 3-3 pcs/box B	Cantliver V1;V2
K32H	6,5	A	-	-	-	-	1 pc/box A	with writing table
K32H	6,5	A	A	B	B	B	1-2 pcs/box A 3-5 pcs/box B	without writing table
K32HC	8,5	A	-	-	-	-	1 pc/box A	
K32HF	8,5	A	-	-	-	-	1 pc/box A	
K32HS	8,5	A	-	-	-	-	1 pc/box A	
K32V	7,5	A	A	B	B	B	1-2 pcs/box A 3-5 pcs/box B	Cantliver V
K32V	7,5	A	A	B	-	-	1-2 pcs/box A 3-3 pcs/box B	Cantliver V1;V2
K42CV	8	B	-	-	-	-	1 pc/box B	
K42H	6	A	-	-	-	-	1 pc/box A	with writing table
K42H	6	A	A	B	B	B	1-2 pcs/box A 3-5 pcs/box B	without writing table
K42HC	9,5	A	-	-	-	-	1 pc/box A	
K42HF	9,5	A	-	-	-	-	1 pc/box A	
K42HS	9,5	A	-	-	-	-	1 pc/box A	
K42V	7	A	A	B	B	B	1-2 pcs/box A 3-5 pcs/box B	Cantliver V
K42V	7	A	A	B	-	-	1-2 pcs/box A 3-3 pcs/box B	Cantliver V1;V2

Type of packaging

Box type legend: A - 670x730x955, 3,2Kg, 0,47m³ B - 670x730x1160, 3,6Kg, 0,5m³

	Product netto weight (Kg)	1 pc	2 pcs	3 pcs	4 pcs	5 pcs	Box Info	Comments
		Box type	Box type	Box type	Box type	Box type		
Chic								
20F	10,5	A	-	-	-	-	1 pc/box A	
20H	9,5	A	-	-	-	-	1 pc/box A	
21F	10,5	A	-	-	-	-	1 pc/box A	
21H	9	A	-	-	-	-	1 pc/box A	
20CH	11	B	-	-	-	-	1 pc/box B	
20CR	25	B	-	-	-	-	1 pc/box B	
21CH	10	B	-	-	-	-	1 pc/box B	
21CR	24	B	-	-	-	-	1 pc/box B	
Ellie^{Pro}								
10 HST	16	B	-	-	-	-	1 pc/box B	
10 HW	15	B	-	-	-	-	1 pc/box B	
10 V3	16	B	-	-	-	-	1 pc/box B	
20 HST	15	B	-	-	-	-	1 pc/box B	
20 HW	14	B	-	-	-	-	1 pc/box B	
20 V3	15	B	-	-	-	-	1 pc/box B	
Fan								
10F	11,5	A	-	-	-	-	1 pc/box A	
10H	10,5	A	-	-	-	-	1 pc/box A	
10V	10,5	A	-	-	-	-	1 pc/box A	
10R	23	A	-	-	-	-	1 pc/box A	
MyTurn								
21VN	12,5	B	-	-	-	-	1 pc/box B	Non stackable cantliver
Normo								
500H	7	A	A	B	B	-	1-2 pcs/box A 3-4 pcs/box B	
500HC	9	A	-	-	-	-	1 pc/box A	
500HS	9,5	A	-	-	-	-	1 pc/box A	
500V	11,5	A	-	-	-	-	1 pc/box A	with long armrest
500V	8	A	A	B	B	-	1-2 pcs/box A 3-4 pcs/box B	without long armrest
Nu								
20F	12	A	-	-	-	-	1 pc/box A	
20H	11	A	-	-	-	-	1 pc/box A	
20R	22	A	-	-	-	-	1 pc/box A	
20V3	11	A	-	-	-	-	1 pc/box A	

Type of packaging

Box type legend: A - 670x730x955, 3,2Kg, 0,47m³ B - 670x730x1160, 3,6Kg, 0,5m³

	Product netto weight (Kg)	1 pc	2 pcs	3 pcs	4 pcs	5 pcs	Box Info	Comments
		Box type	Box type	Box type	Box type	Box type		
Sun								
H	5	A	B	B	-	-	1-1 pc/box A 2-3 pcs/box B	with writing table
H	5	A	B	B	B	-	1-1 pc/box A 2-4 pcs/box B	without writing table
H 2P	6	A	B	B	-	-	1-1 pc/box A 2-3 pcs/box B	with writing table
H 2P	6	A	B	B	B	-	1-1 pc/box A 2-4 pcs/box B	without writing table
V 2P	9,5	A	B	B	-	-	1-1 pc/box A 2-3 pcs/box B	with writing table
V 2P	9,5	A	B	B	-	-	1-1 pc/box A 2-3 pcs/box B	without writing table
Xenon								
20H	9,5	A	A	B	-	-	1-2 pcs/box A 3-3 pcs/box B	
20V	12	A	B	B	-	-	1-1 pc/box A 2-3 pcs/box B	
Xenon Net								
20H	9	A	A	B	-	-	1-2 pcs/box A 3-3 pcs/box B	
20V	11,5	A	B	B	-	-	1-1 pc/box A 2-3 pcs/box B	
Zoo								
500 H	7,5	A	A	A	-	-	1-3 pcs /box A	without writing table and castors
500 H	7,5	A	-	-	-	-	1 pc/box A	with writing table and glide
500 HC	8	A	-	-	-	-	1 pc/box A	with castors
500 V	8,5	A	A	A	-	-	1-3 pcs /box A	without writing table
500 V	8,5	A	-	-	-	-	1 pc/box A	with writing table
502 H	7	A	A	A	-	-	1-3 pcs /box A	without writing table and castors
502 H	7	A	-	-	-	-	1 pc/box A	with writing table and glide
502 HC	7	A	-	-	-	-	1 pc/box A	with castors
502 V	8	A	A	A	-	-	1-3 pcs /box A	without writing table
502 V	8	A	-	-	-	-	1 pc/box A	with writing table
522 H	7	A	A	A	-	-	1-3 pcs /box A	without writing table and castors
522 H	7	A	-	-	-	-	1 pc/box A	with writing table and glide
522 HC	7,5	A	-	-	-	-	1 pc/box A	with castors
522 V	8	A	A	A	-	-	1-3 pcs /box A	without writing table
522 V	8	A	-	-	-	-	1 pc/box A	with writing table

Technical details

Allround

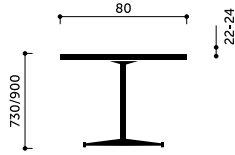

Allround 5180-30

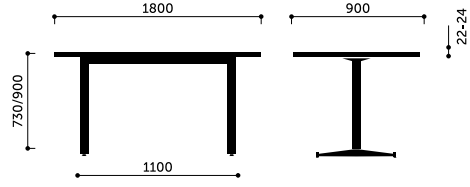

Allround 5180-10

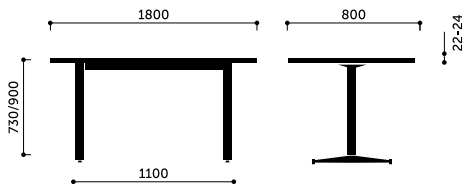

Allround 5180-22

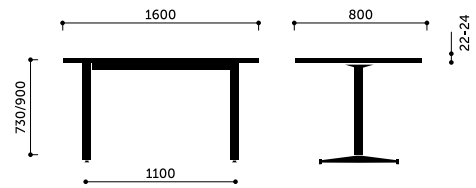

Allround 5180-24

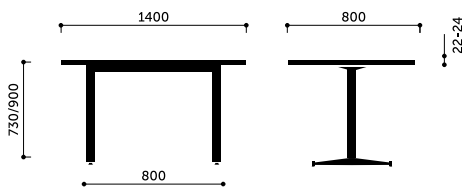

Allround 5180-25

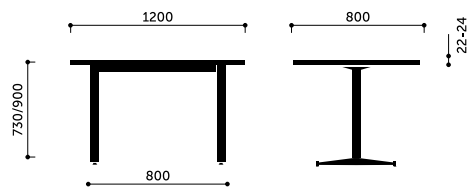

Allround 5180-27

Technical details

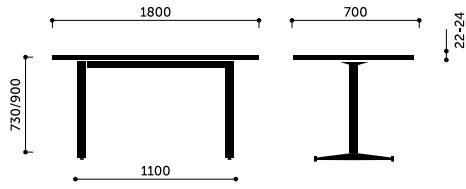

Allround 5180-36

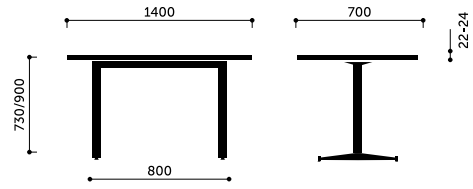

Allround 5180-38

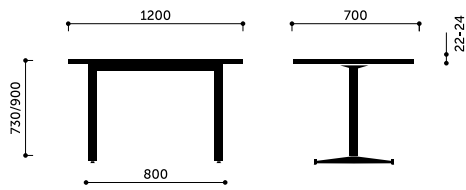

Allround 5180-39

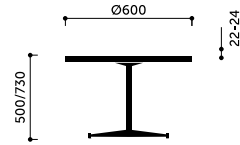

Allround 5182-10

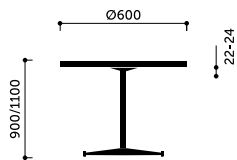

Allround 5182-102

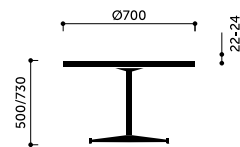

Allround 5182-15

Technical details

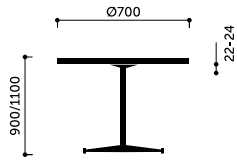

Allround 5182-152

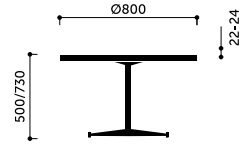

Allround 5182-20

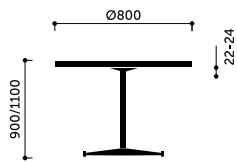

Allround 5182-202

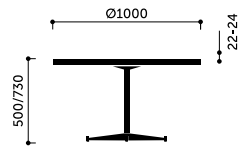

Allround 5182-25

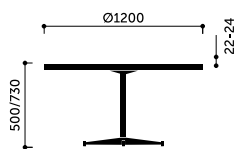

Allround 5182-30

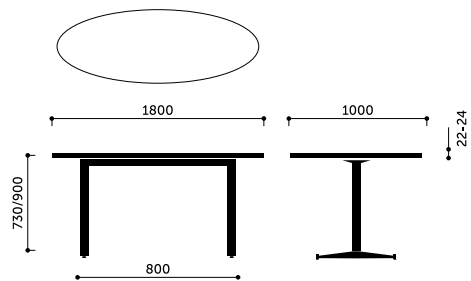

Allround 5184-01

Technical details

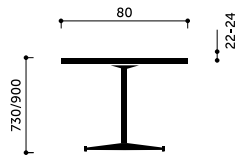

Allround 5180-30

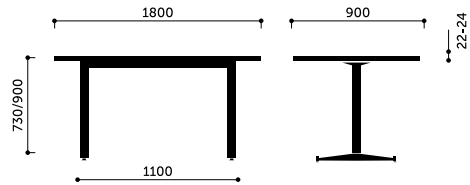

Allround 5180-10

Ana

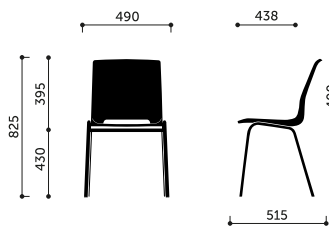

4340 / 4340S / 4340SR

Ariz

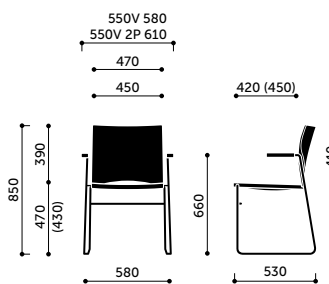

550V / 550V 2P

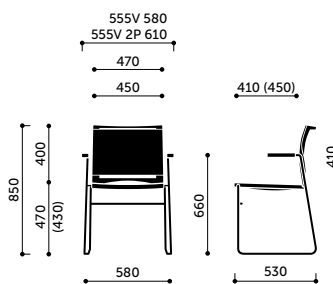

555V / 555V 2P

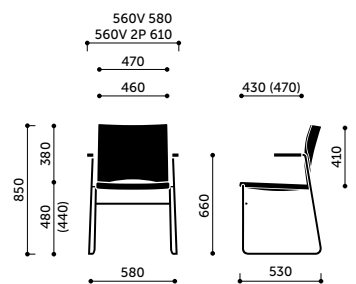

560V / 560V 2P

10,5 kg 15
 6,5 kg 45
 12,0 kg 10
 8,0 kg 45

0,50 m³

6,0 kg 15
 7,5 kg 45
 10
 45

7,0 kg 5
 8,5 kg 20
 5
 20

Technical details

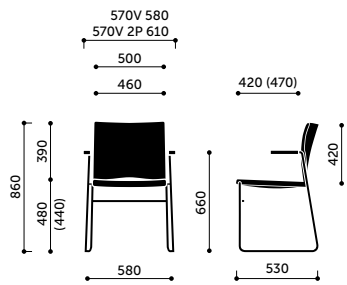

570V / 570V 2P

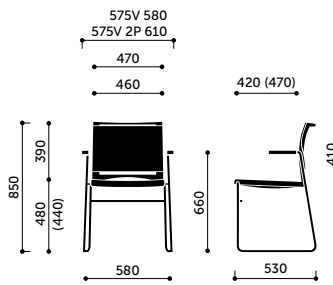
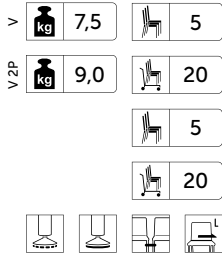

575V / 575V 2P

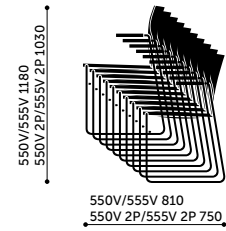
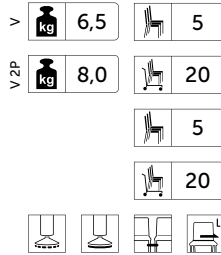

stacking

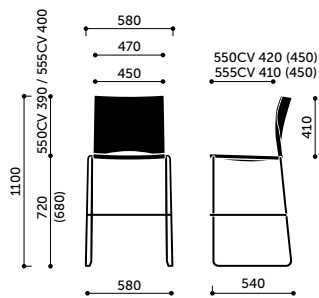

550CV / 555CV

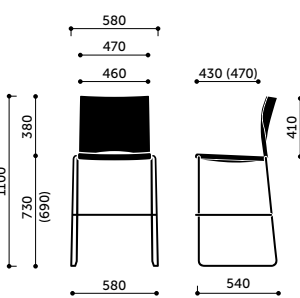
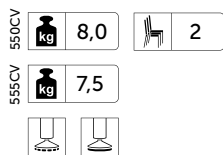

560CV

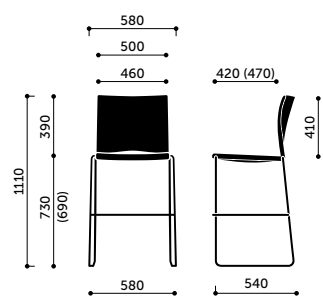

570CV / 575CV

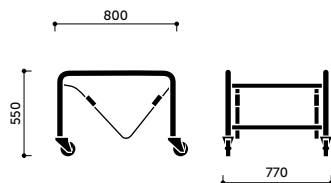
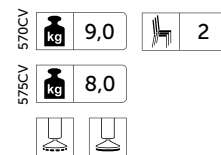

W (chairs trolley)

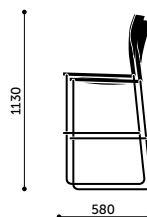

stacking CV

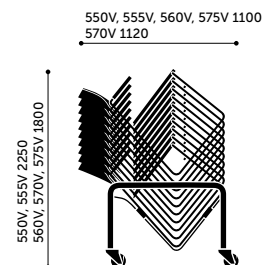

stacking on trolley

Technical details

Bit

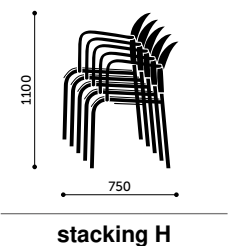
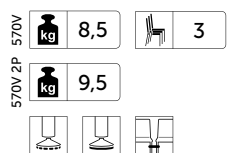
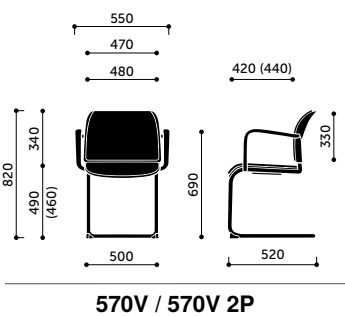
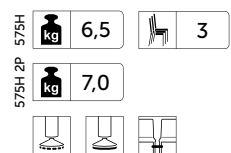
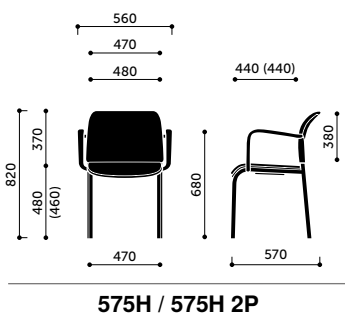
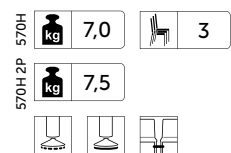
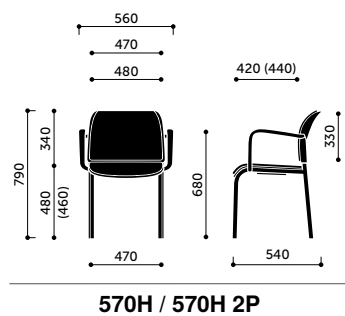
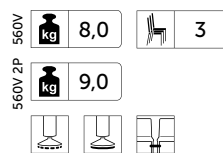
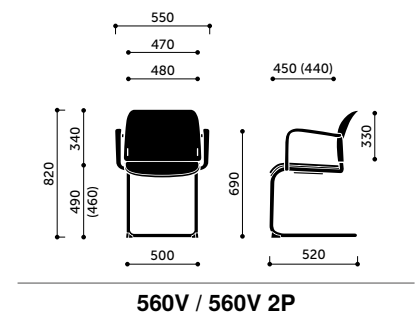
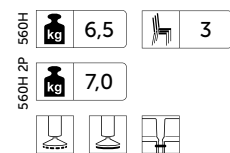
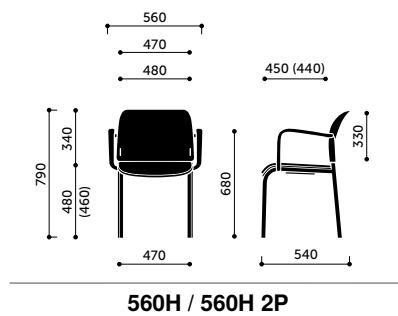
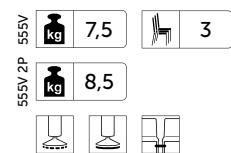
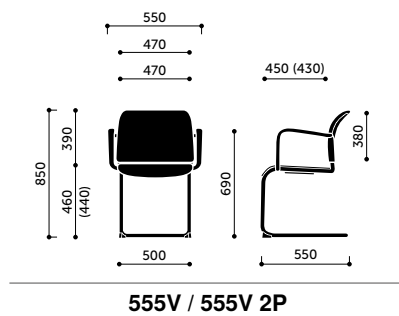
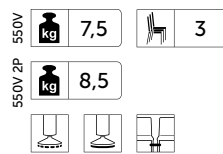
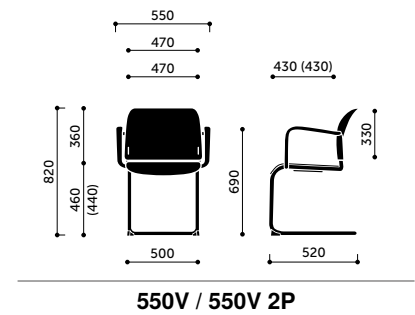
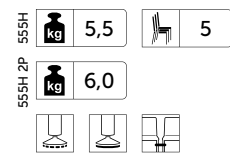
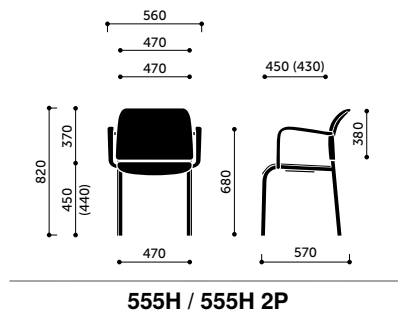
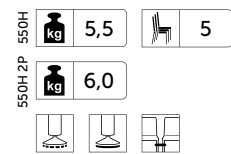
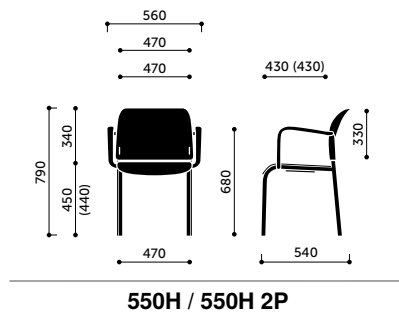

Technical details

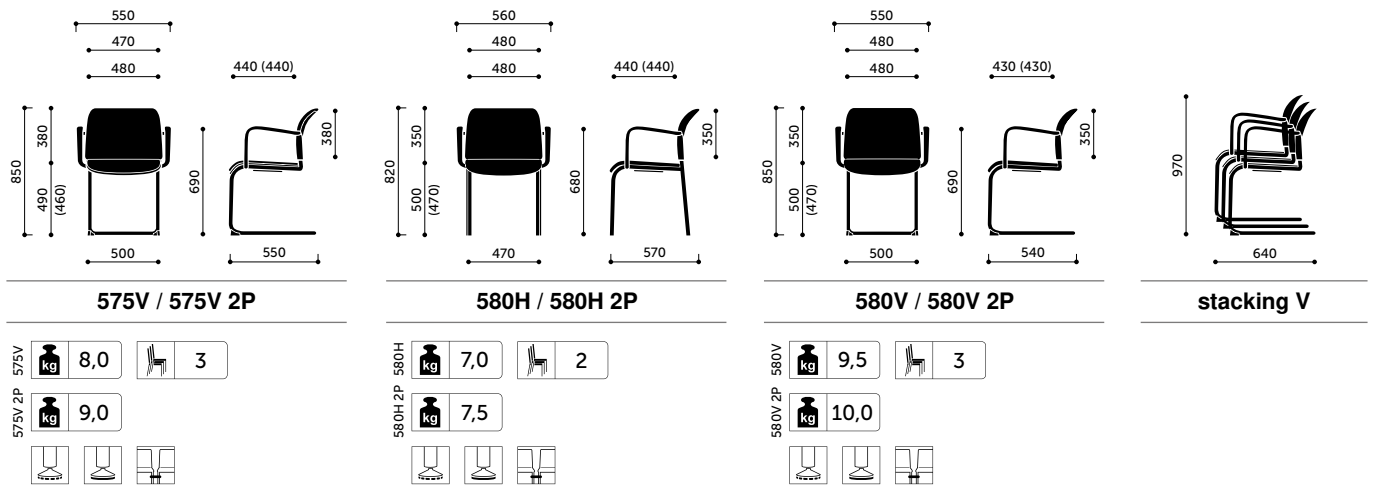

Chic

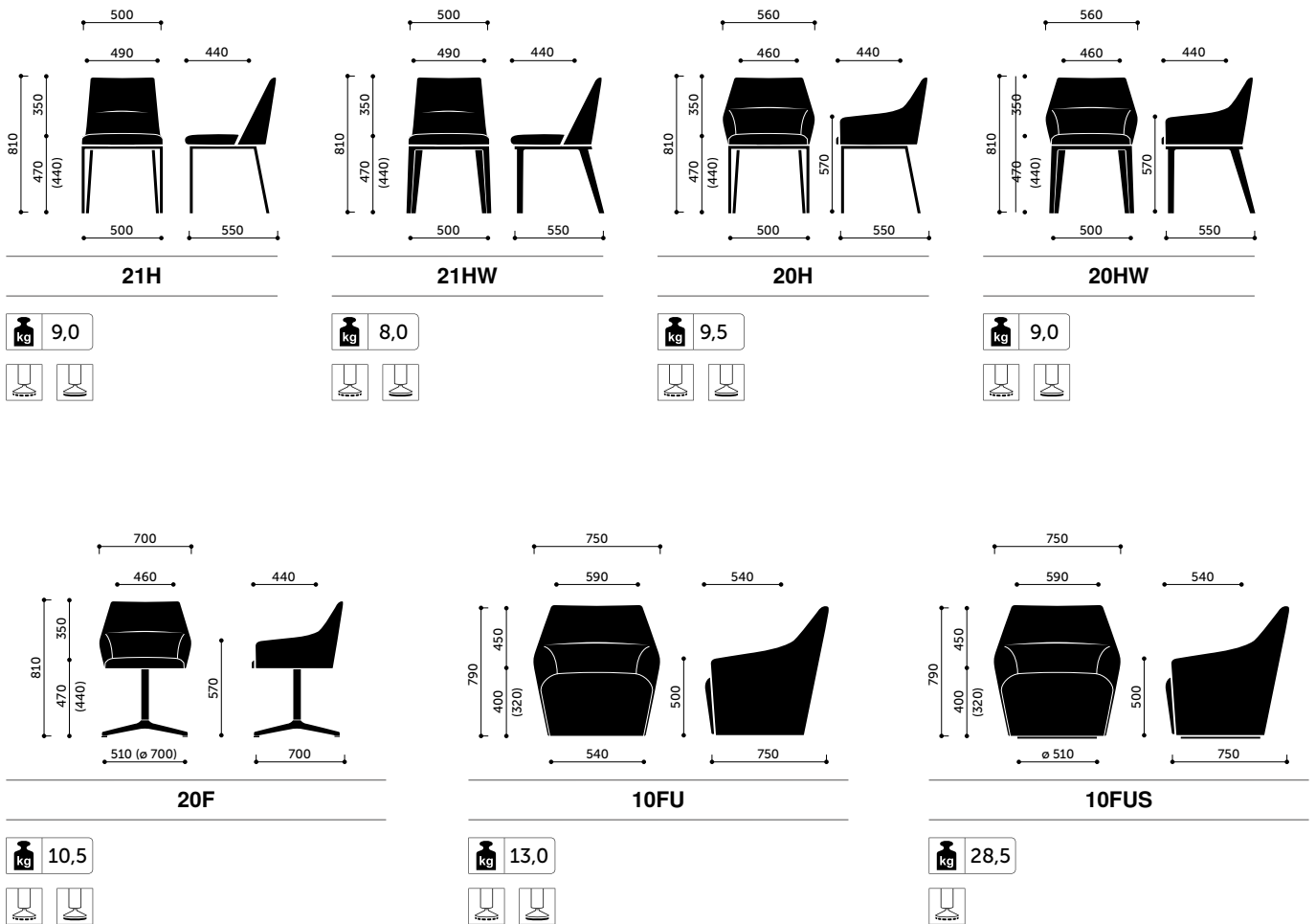

Technical details

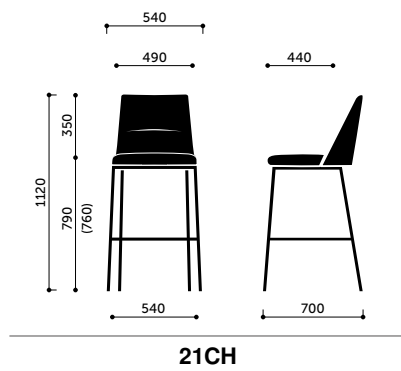

21CH

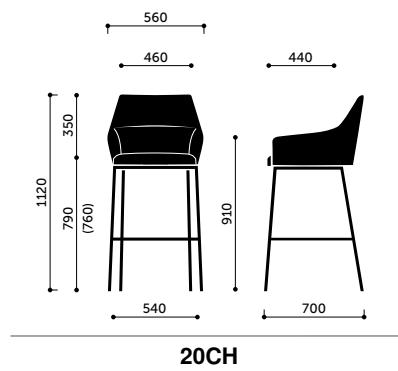

20CH

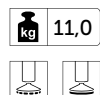

Chic Lounge

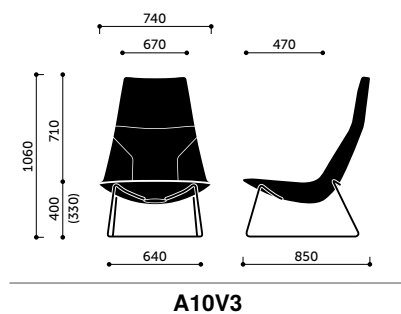

A10V3

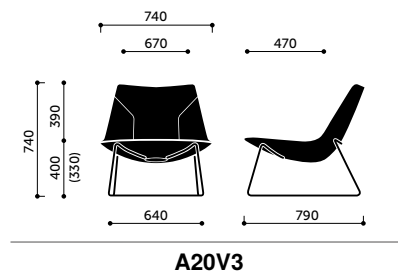
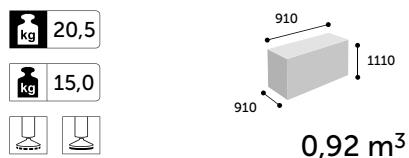

A20V3

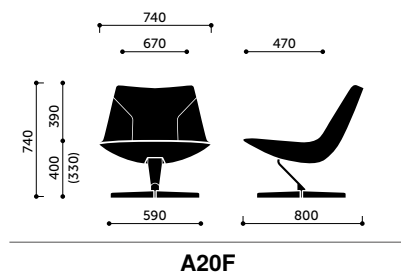
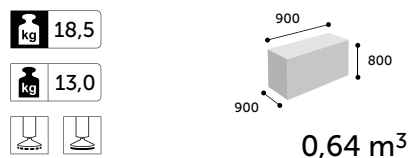

A20F

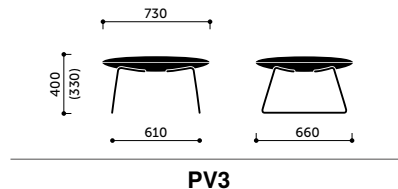
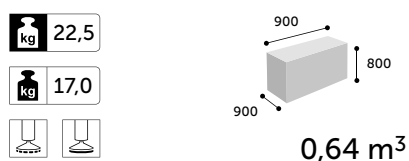

PV3

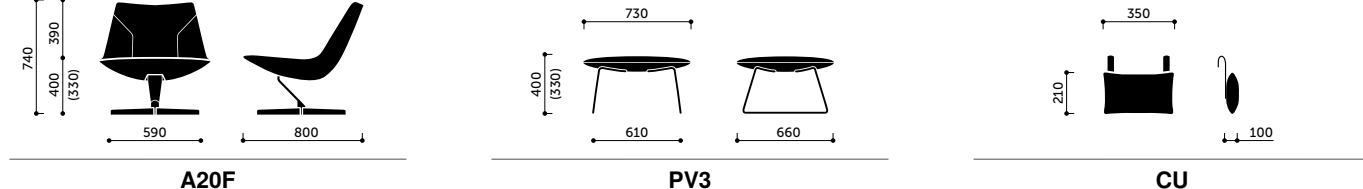
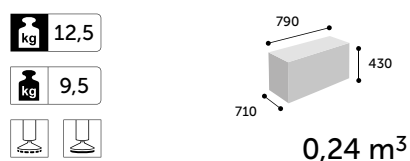

CU

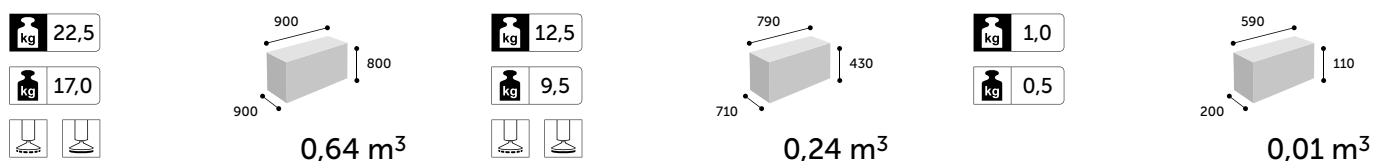

Technical details

Chic Tables

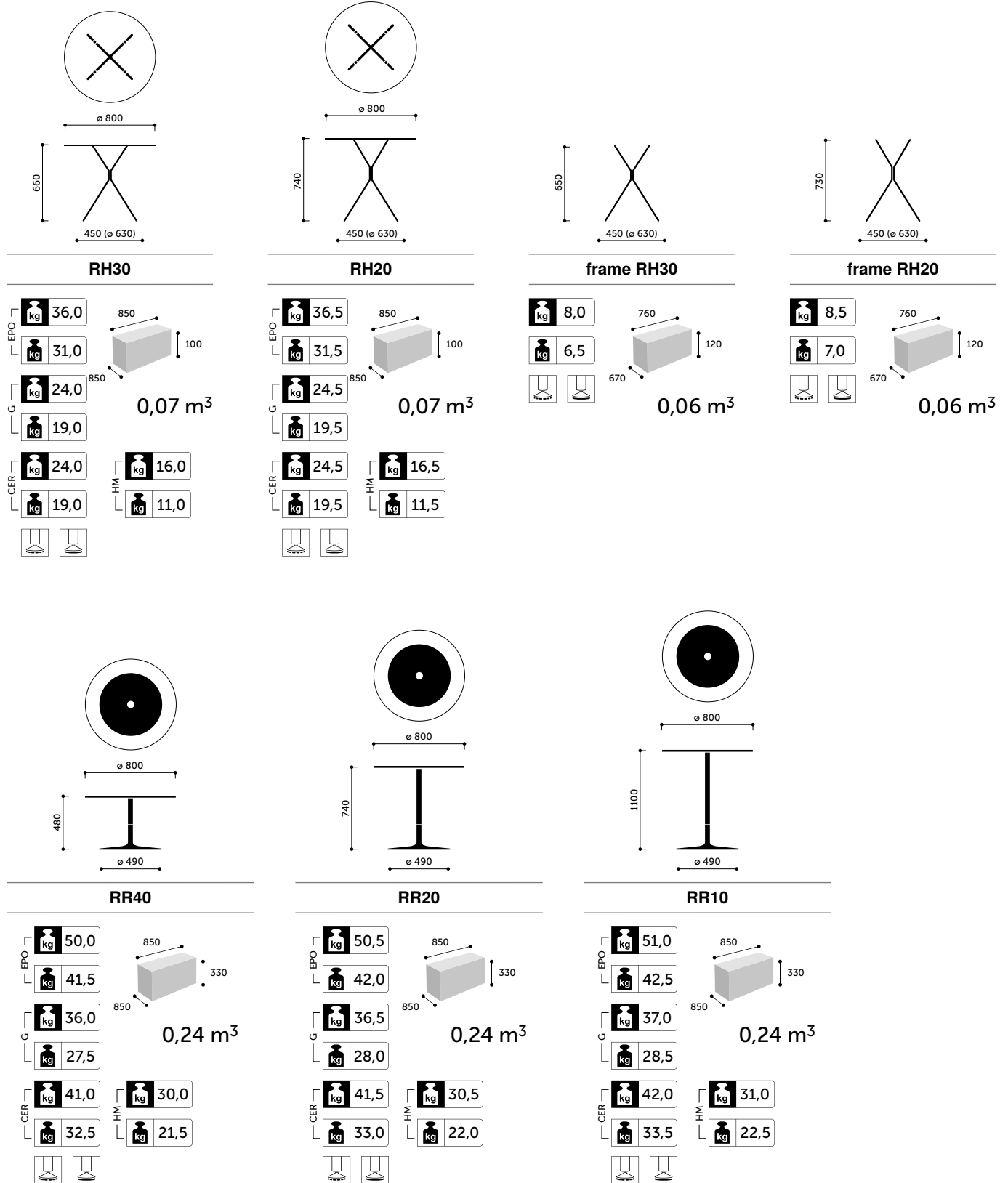

Technical details

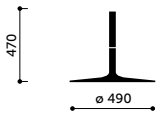

frame RR40

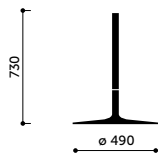
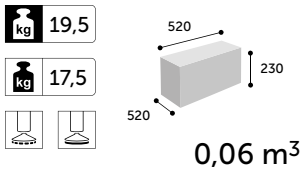

frame RR20

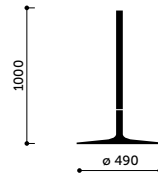
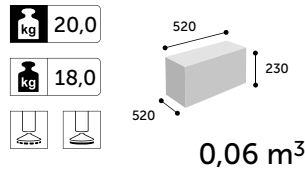

frame RR10

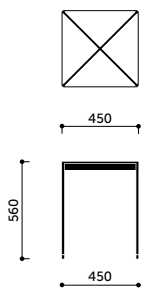
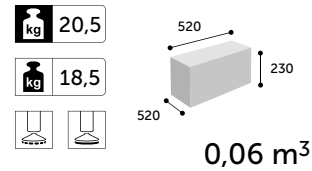

CS30

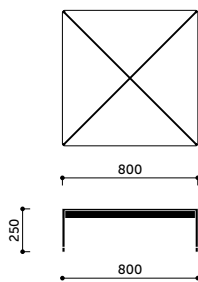
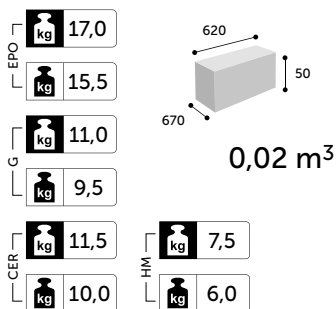

CS40

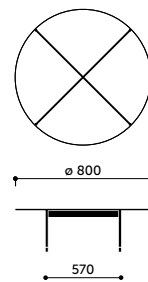
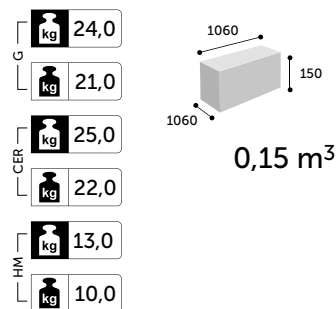

CR40

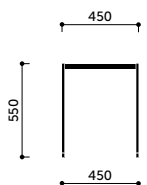
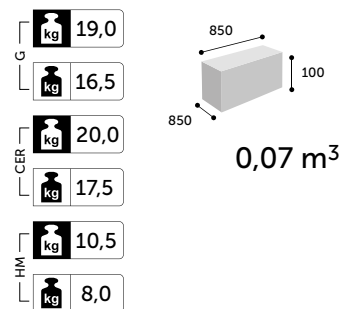

frame CS30

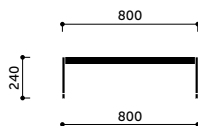
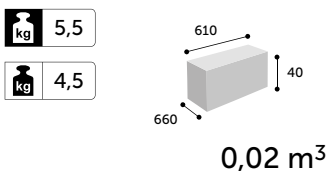

frame CS40

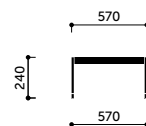
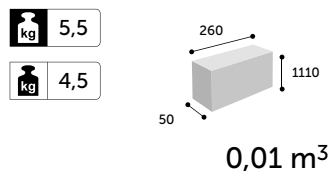

frame CR40

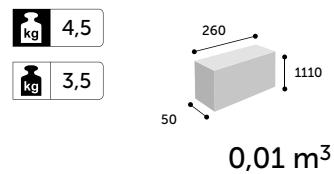

Technical details

Com

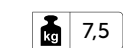
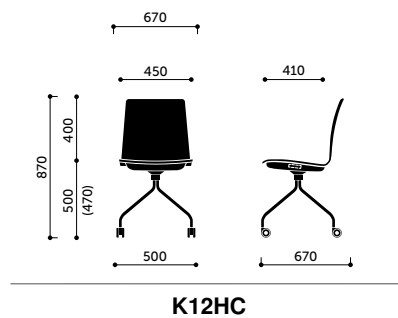
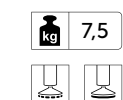
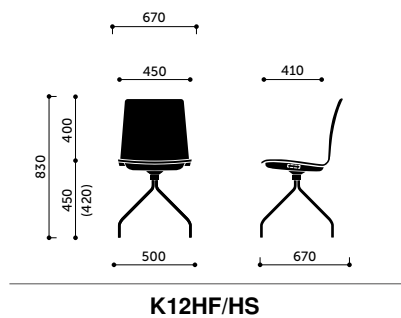
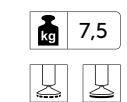
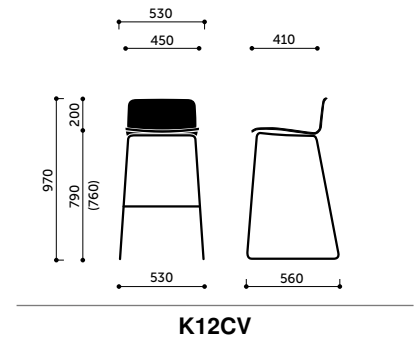
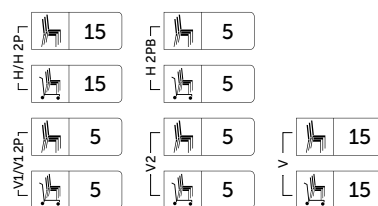
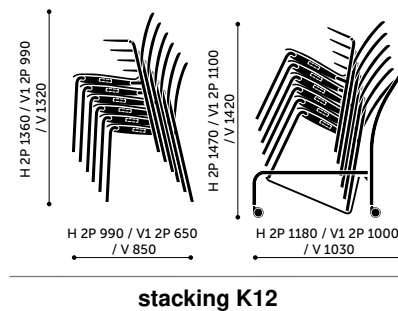
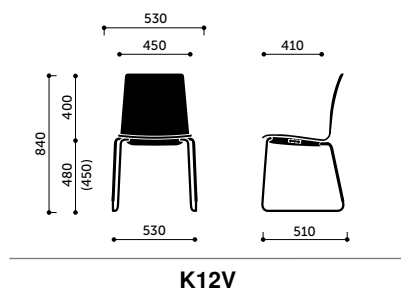
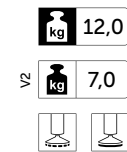
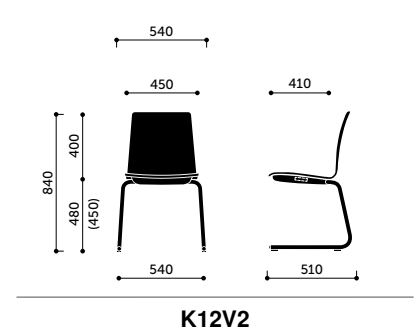
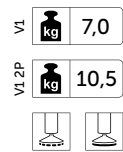
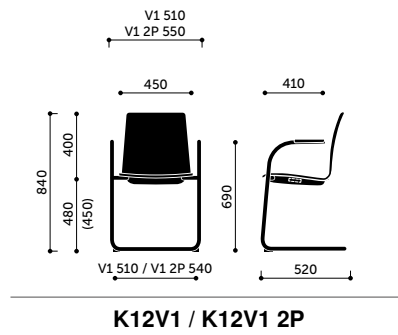
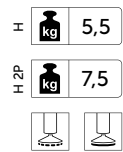
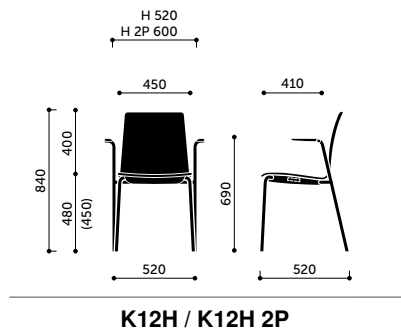

Technical details

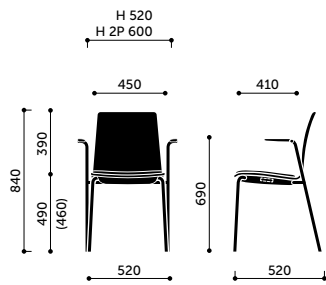

K22H / K22H 2P

H **kg** 6,0

H 2P **kg** 8,0

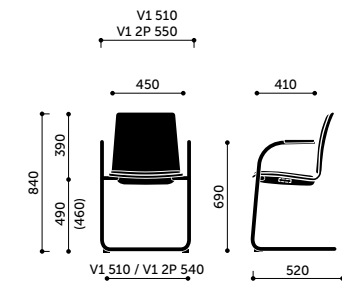

K22V1 / K22V1 2P

V1 **kg** 7,5

V1 2P **kg** 11,0

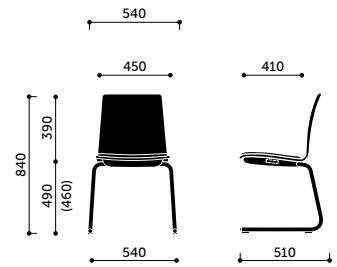
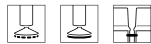

K22V2

V2 **kg** 7,5

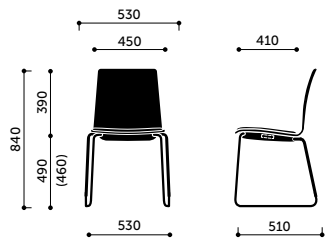

K22V

kg 7,0

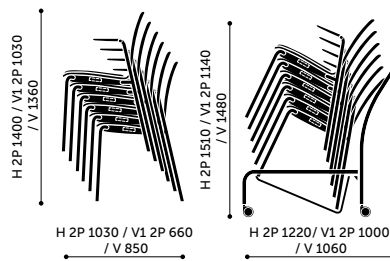

stacking K22

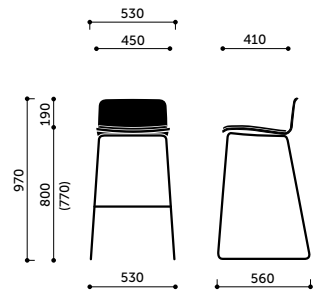
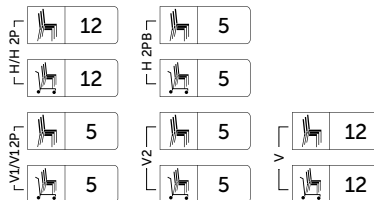

K22CV

kg 8,0

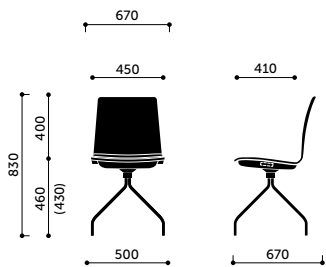

K22HF/HS

kg 8,0

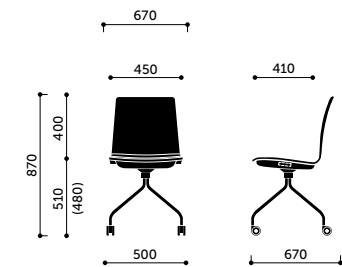

K22HC

kg 8,0

Technical details

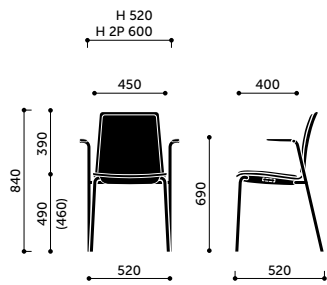

K32H / K32H 2P

H **kg** 6,5

H 2P **kg** 8,5

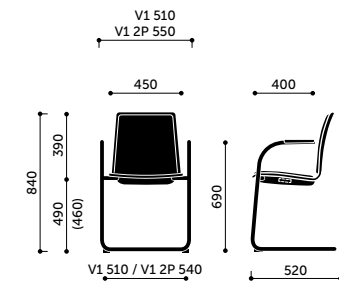

K32V1 / K32V1 2P

V1 **kg** 8,0

V1 2P **kg** 11,5

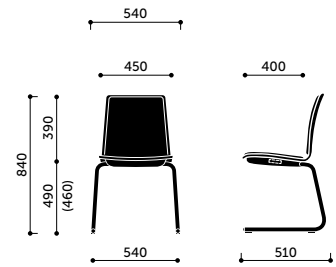
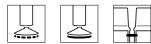

K32V2

V2 **kg** 8,0

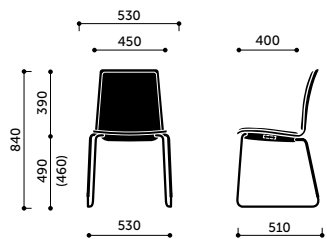

K32V

kg 7,5

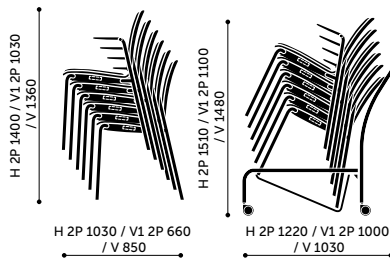

stacking K32

H/H/H 2P 12

H 2PB 5

H/H/H 2P 12

H 2PB 5

V/V/V1 2P 5

V2 5

V 12

V/V/V1 2P 5

V 5

V 12

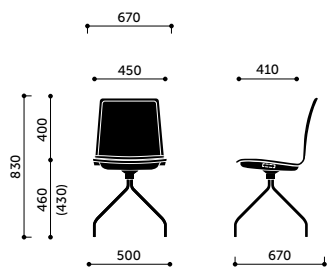

K32HF/HS

kg 8,5

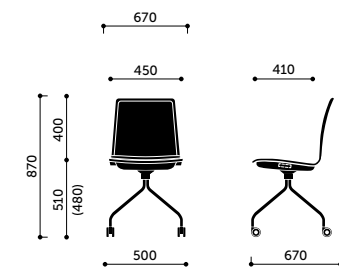

K32HC

kg 8,5

Technical details

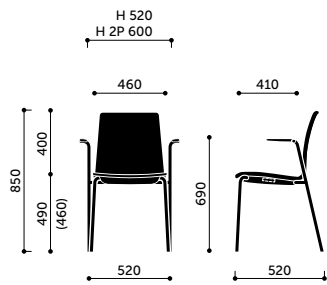

K42H / K42H 2P

H **kg** 6,0

H 2P **kg** 8,0

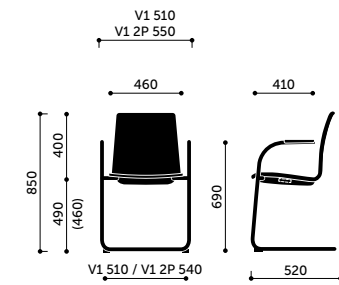

K42V1 / K42V1 2P

V1 **kg** 7,5

V1 2P **kg** 11,0

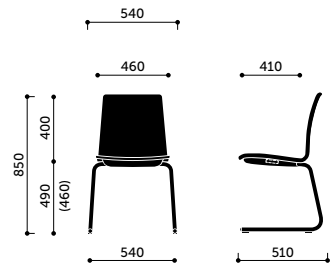

K42V2

V2 **kg** 7,5

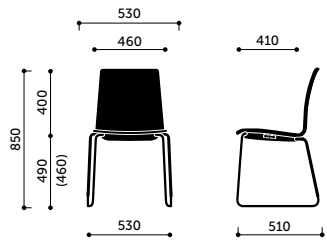

K42V

kg 7,0

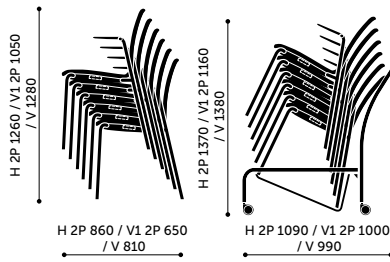

stacking K42

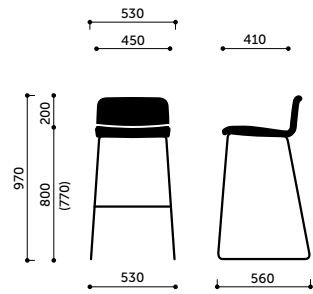
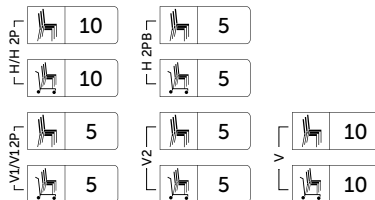

K42CV

kg 8,0

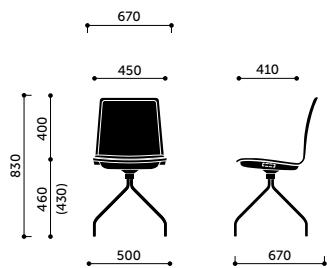

K32HF/HS

kg 8,5

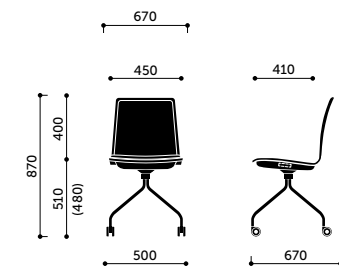

K32HC

kg 8,5

Technical details

Ellie^{Pro}

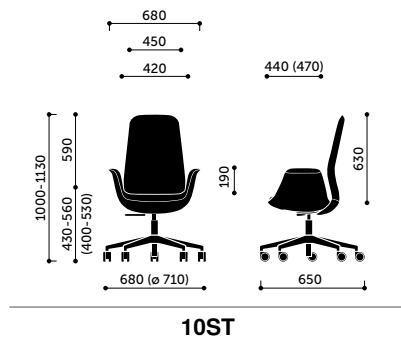

10ST

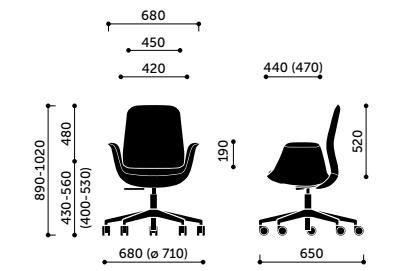

20ST

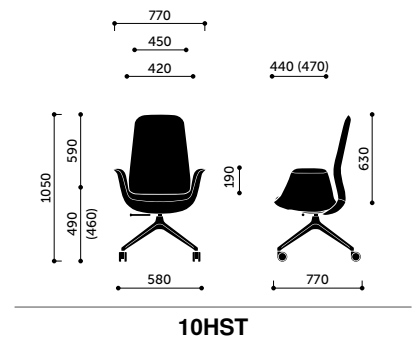

10HST

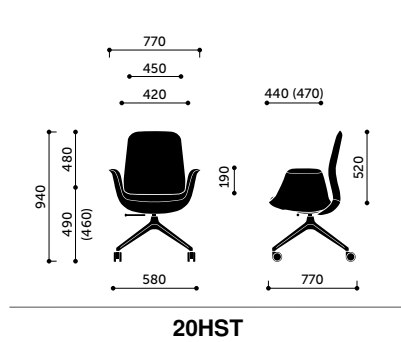
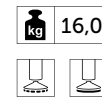

20HST

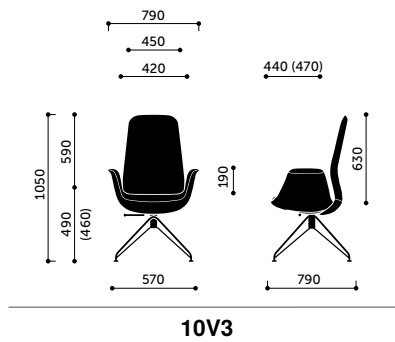

10V3

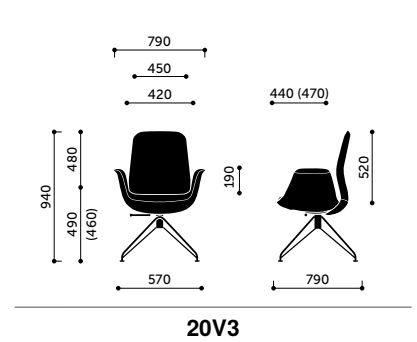

20V3

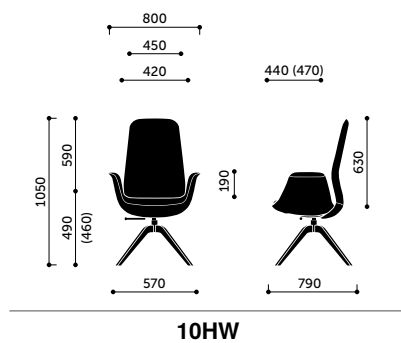
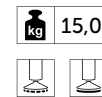

10HW

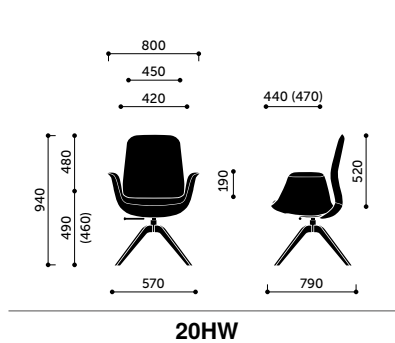

20HW



Technical details

Eminent

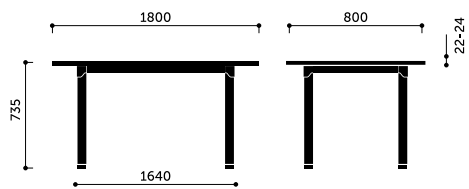

Eminent 4590-22

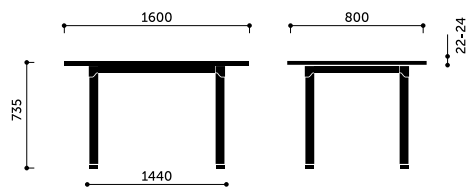

Eminent 4590-24

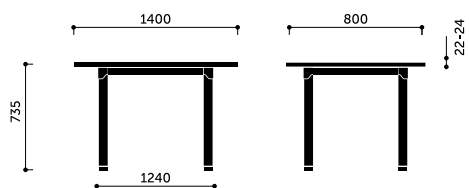

Eminent 4590-25

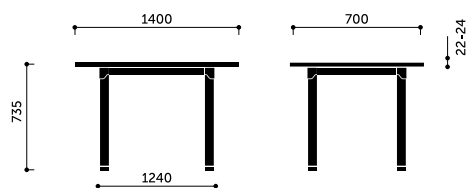

Eminent 4590-38

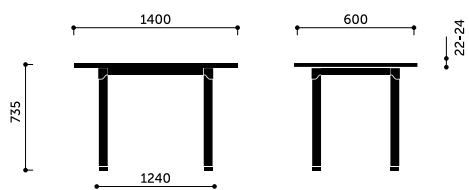

Eminent 4590-52

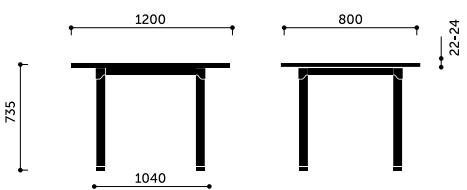

Eminent 4590-27

Technical details

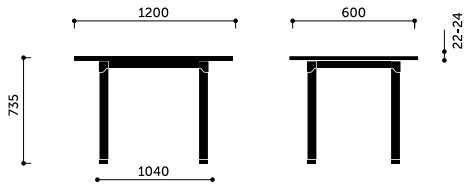

Eminent 4590-54

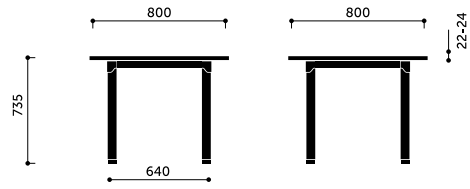

Eminent 4590-30

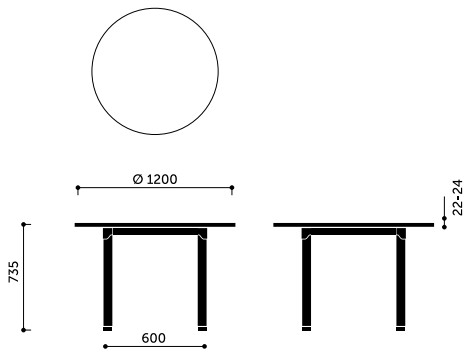

Eminent 4592-30

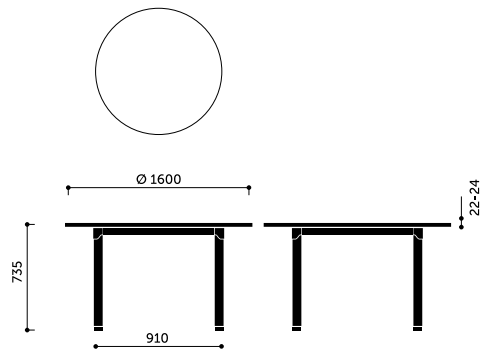

Eminent 4592-50

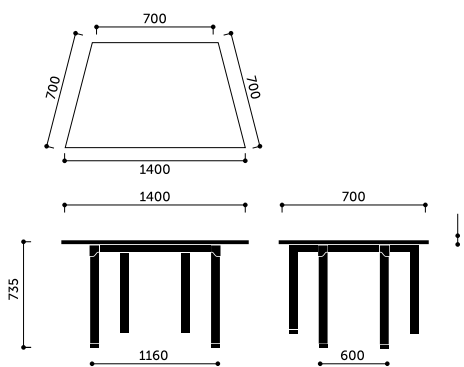

Eminent 4592-50

Technical details

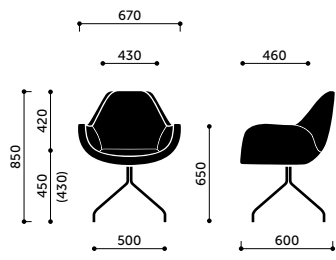

10H / 10HS

kg 10,5

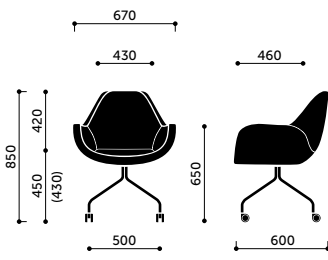

10HC

kg 10,5

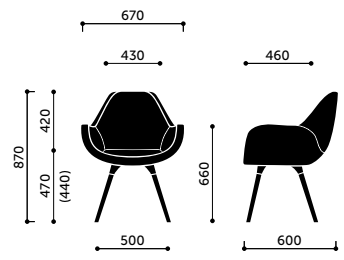

10HW

kg 9,5

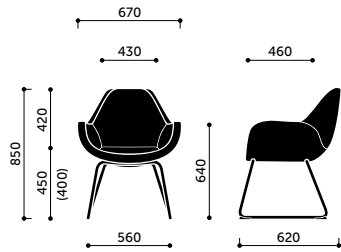

10V

kg 10,5

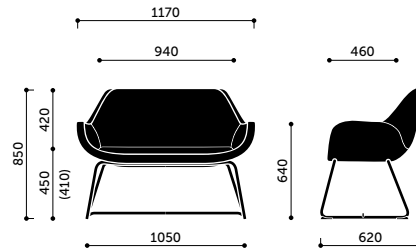

20V

kg 17,0

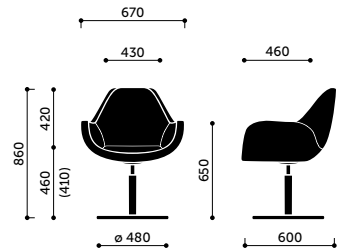

10R

kg 23,0

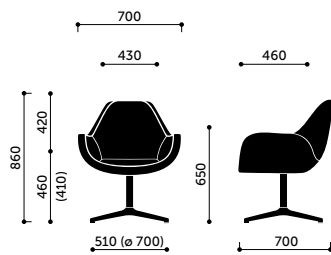

10F

kg 11,5

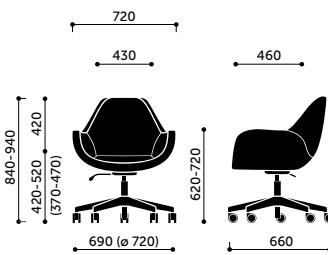

10Z

kg 12,0

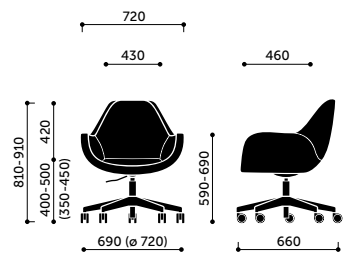

10E

kg 13,0



Technical details

Mickey

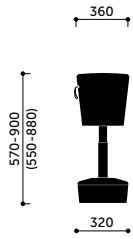

Mickey

kg 13,5

kg 11,5

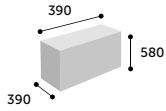

0,09 m³

MyTurn Sofa

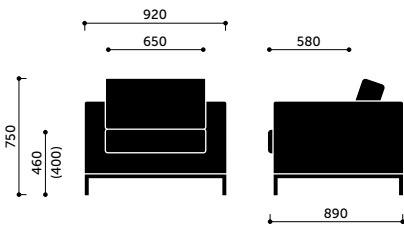

10H / 10V

kg 40,0

kg 35,0

kg 45,5

kg 40,5

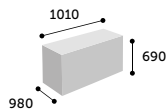

0,68 m³

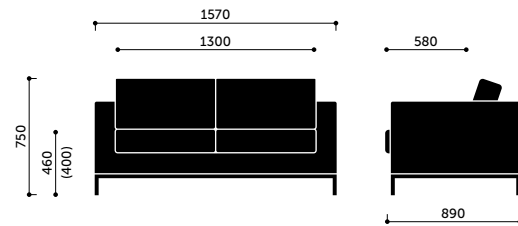

20H / 20V

kg 60,5

kg 54,0

kg 61,5

kg 55,0

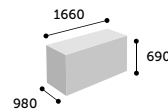

1,12 m³

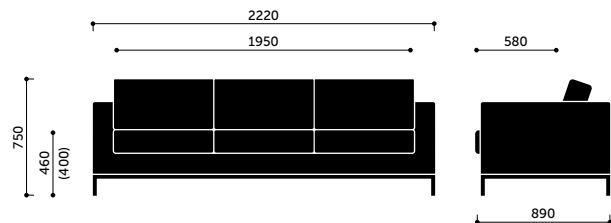

30H / 30V

kg 76,0

kg 67,5

kg 77,0

kg 68,5

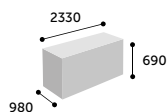

1,58 m³

Technical details

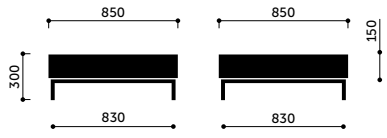

S2H

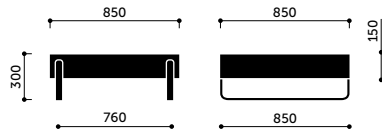

S2V

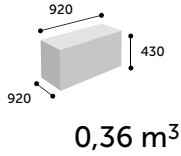
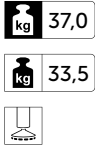

0,36 m³

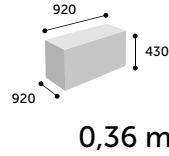
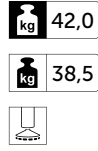

0,36 m³

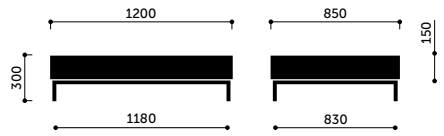

S1H

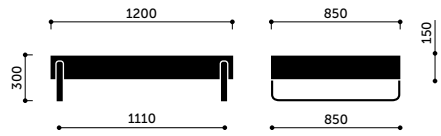

S1V

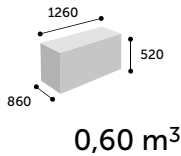
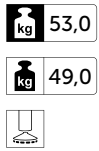

0,60 m³

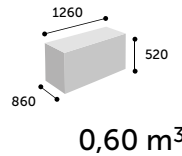
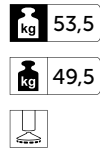

0,60 m³

Noor

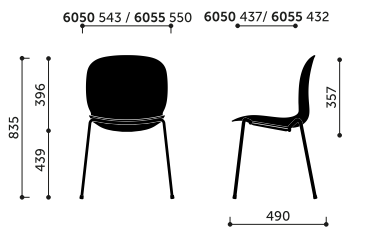

6050 / 6055

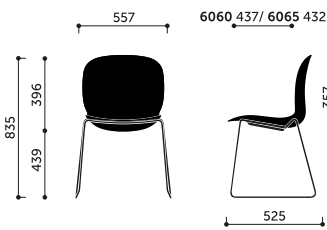

6060 / 6065

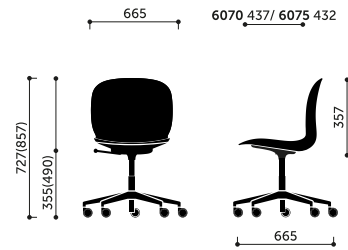

6070 / 6075

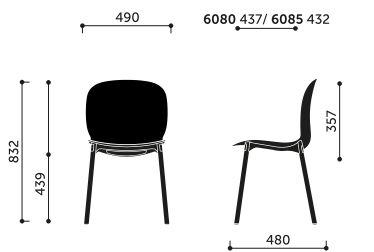

6080 / 6085

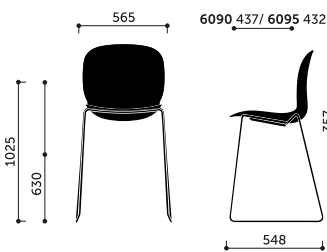

6090 / 6095

Technical details

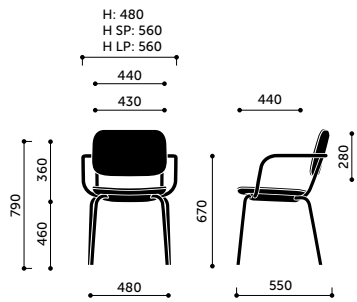

H / H SP / H LP

H 7,0

H SP 8,0

H LP 8,5

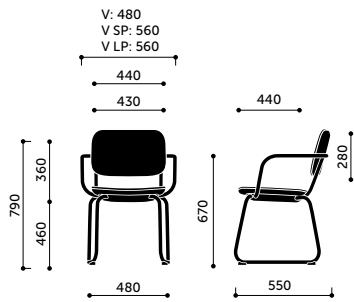

V / V SP / V LP

V 8,0

V SP 8,5

V LP 9,0

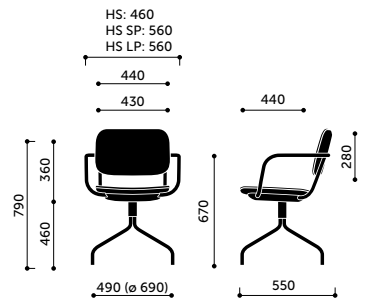

HS / HS SP / HS LP

HS 9,5

HS SP 10,0

HS LP 10,5

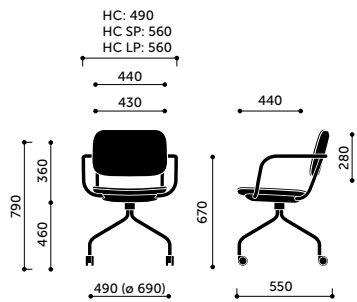

HC / HC SP / HC LP

HC 9,0

HC SP 10,0

HC LP 10,5

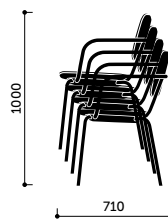

stacking H / H SP / H LP / V / V SP

4

Technical details

Nu

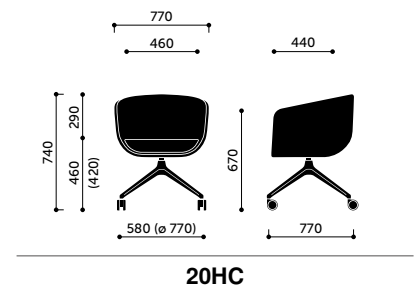
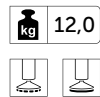
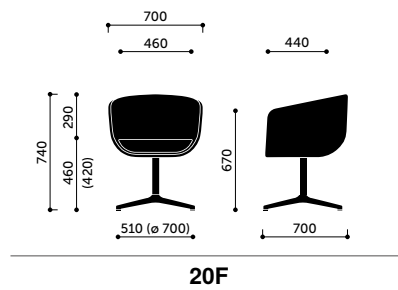
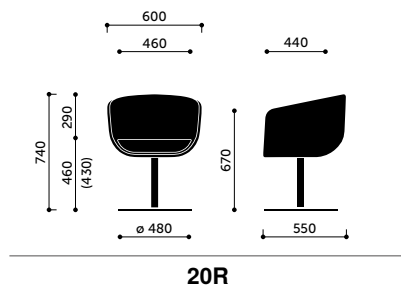
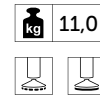
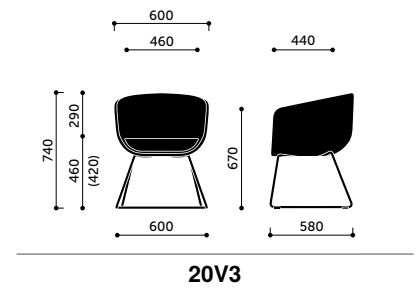
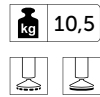
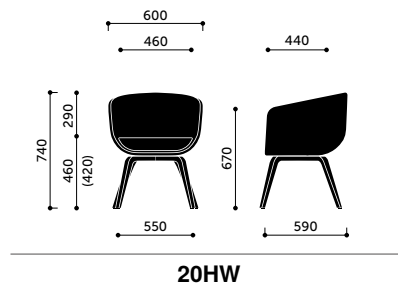
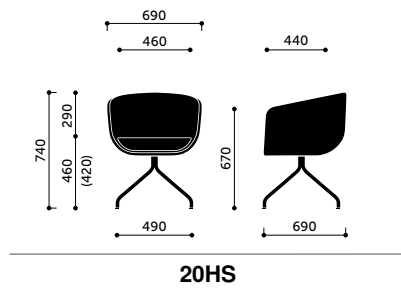

October

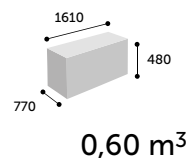
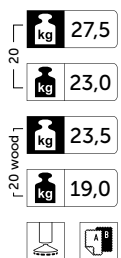
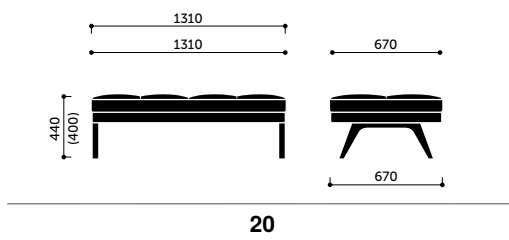
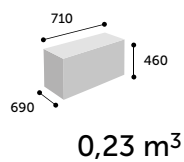
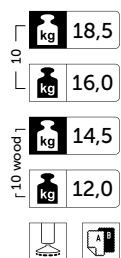
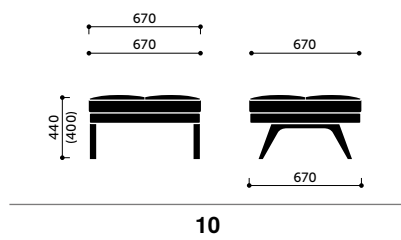

Technical details

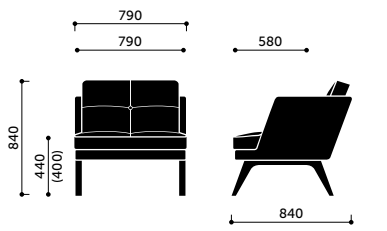

11

11	kg 38,5	900	800	0,64 m ³
	kg 34,0			
11 wood	kg 34,5	900	800	0,64 m ³
	kg 30,0			

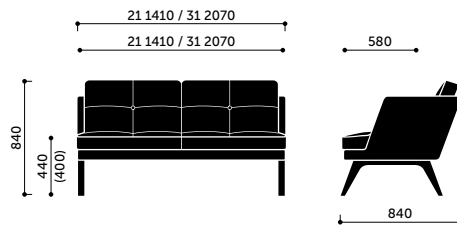

21 / 31

21	kg 49,5	1750	810	1,40 m ³
	kg 42,0			
31	kg 64,5	2330	690	1,58 m ³
	kg 56,0			
21 wood	kg 45,5	960	810	1,40 m ³
	kg 38,0			
31 wood	kg 60,5	980	690	1,58 m ³
	kg 52,0			

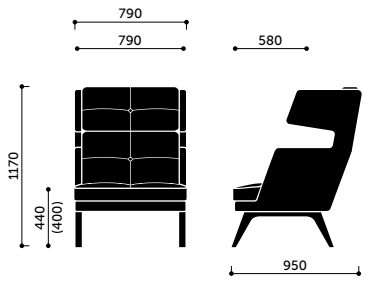

12

12	kg 49,0	970	1210	1,15 m ³
	kg 41,0			
12 wood	kg 45,0	980	1210	1,15 m ³
	kg 37,0			

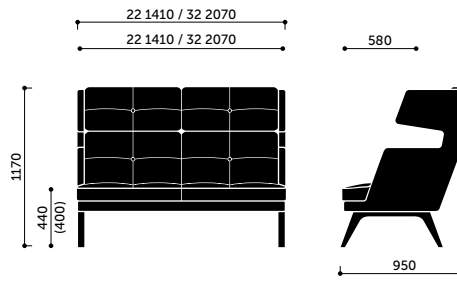

22 / 32

22	kg 70,5	1620	1210	1,90 m ³
	kg 59,0			
32	kg 89,0	2300	1210	2,70 m ³
	kg 77,5			
22 wood	kg 66,5	980	1210	1,90 m ³
	kg 55,0			
32 wood	kg 85,0	980	1210	2,70 m ³
	kg 73,5			

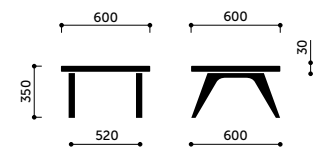

S2

S2	kg 15,0	610	360	0,13 m ³
	kg 13,0			
S2 wood	kg 11,0	610	360	0,13 m ³
	kg 9,0			

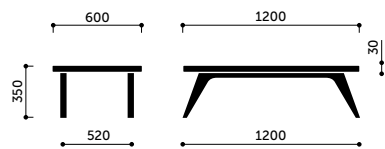

S1

S1	kg 27,5	1250	400	0,33 m ³
	kg 24,5			
S1 wood	kg 21,5	650	400	0,33 m ³
	kg 18,5			

Technical details

Revo

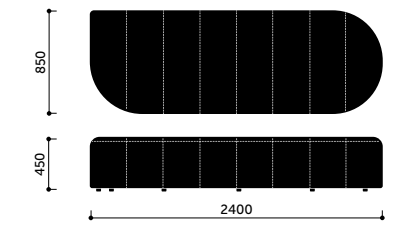

SW240

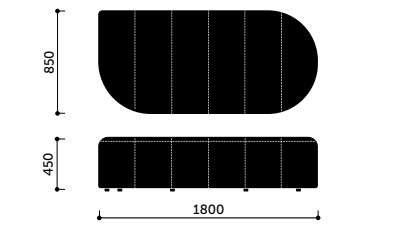

SW180

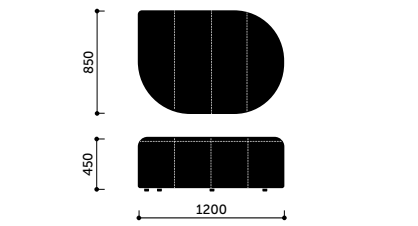

SW120

50,5
42,0
930

1,10 m³

40,5
34,0
930

0,85 m³

27,0
21,0
930

0,60 m³

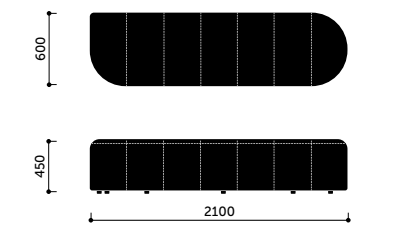

SN210

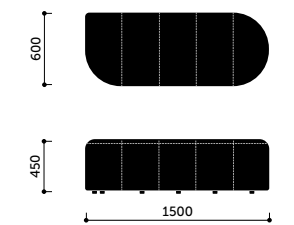

SN150

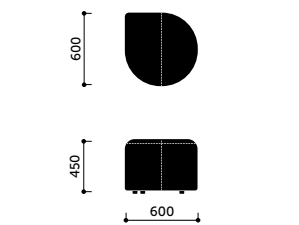

P60

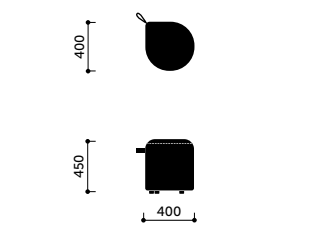

P40

34,0
27,0
680

0,70 m³

23,5
19,0
780

0,60 m³

8,5
6,5
720

0,25m³

4,5
3,5
490

0,12m³

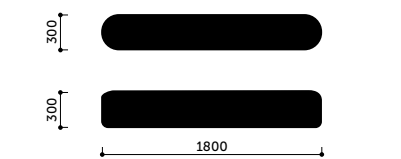

B180

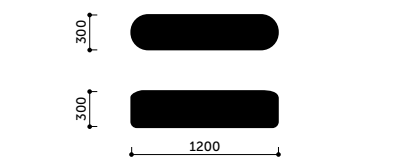

B120

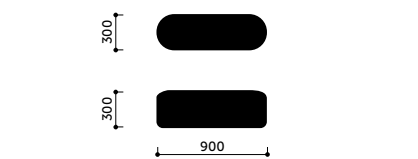

B90

14,0
10,0
560

0,35 m³

11,5
8,0
560

0,25 m³

8,0
5,0
560

0,18m³

Technical details

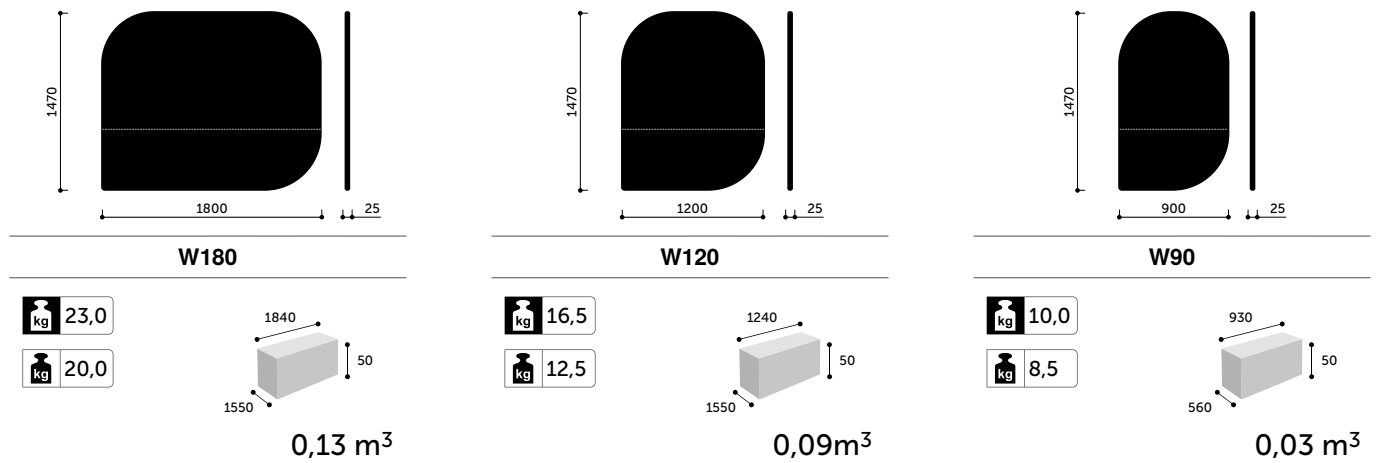

Revo Tables

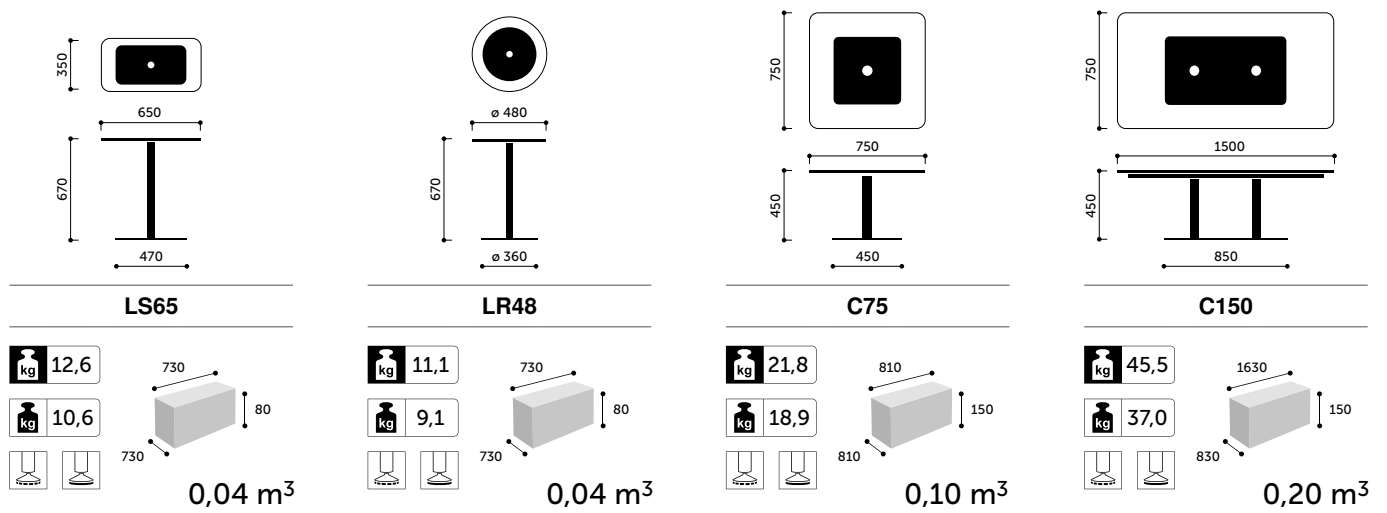

Technical details

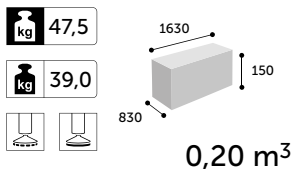
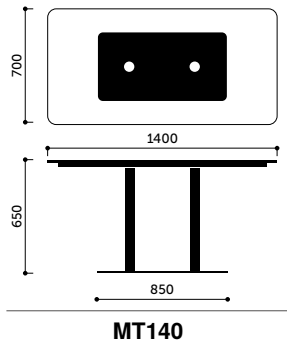
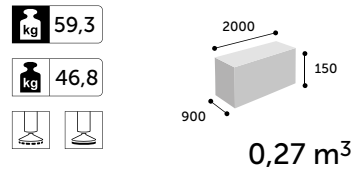
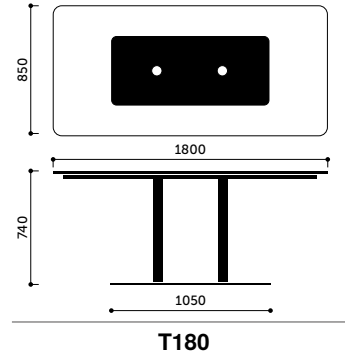
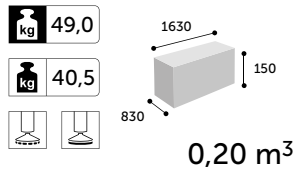
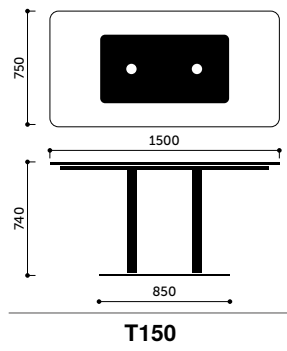
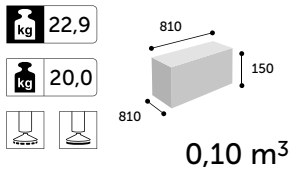
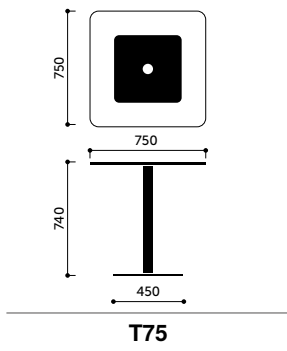

Seven

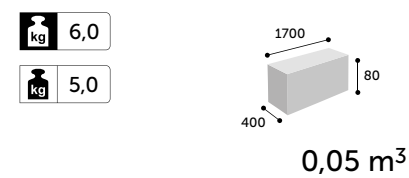
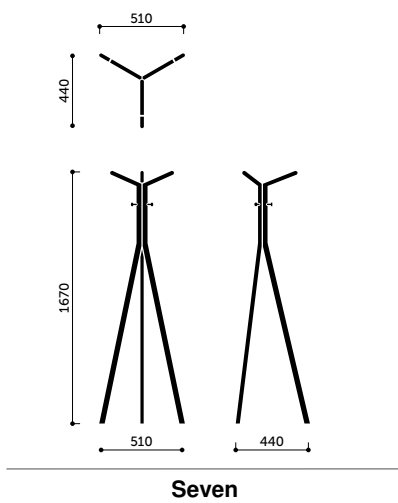

Technical details

Snap

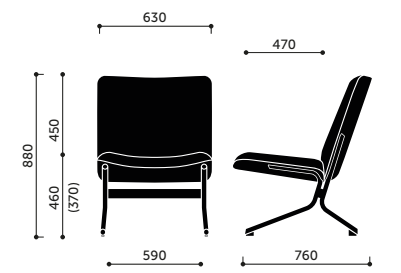

20H

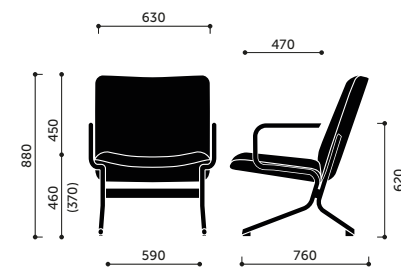
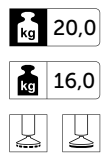

20H 2P

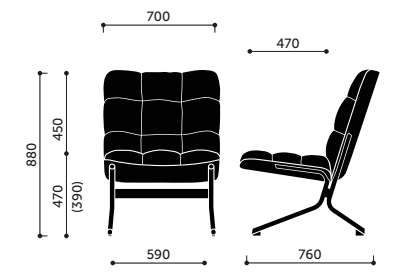
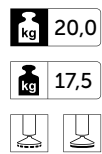

21H

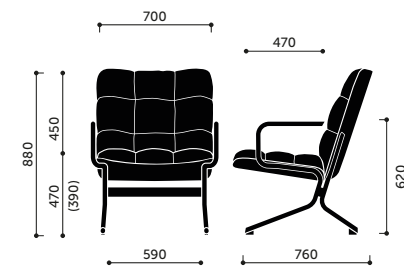
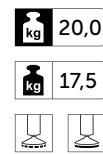

21H 2P

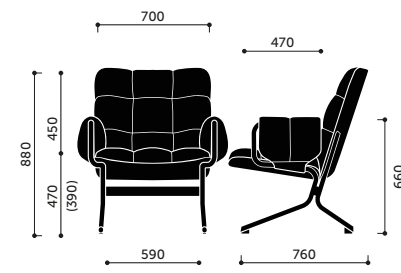
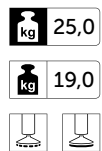

21H 2PF

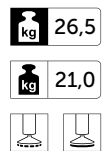

SoftBox

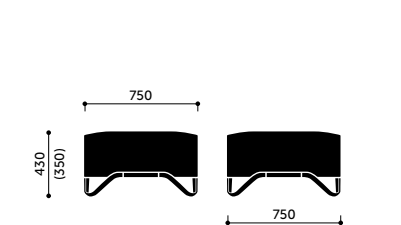

10

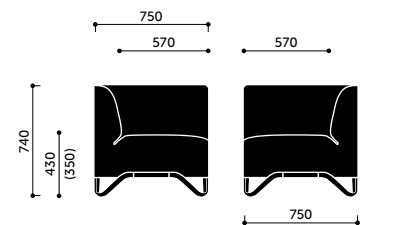
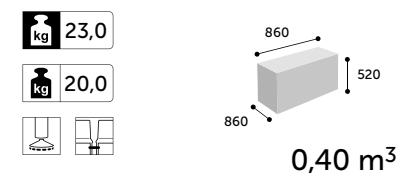

10C

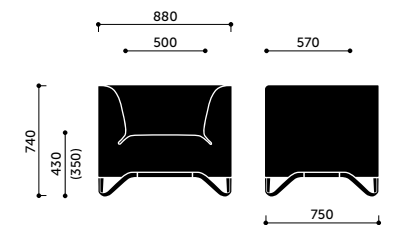
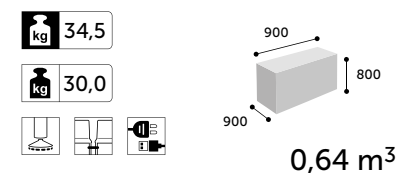

11

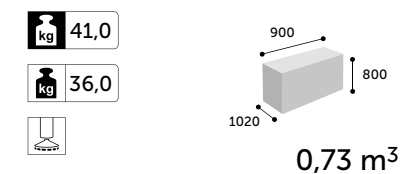

Technical details

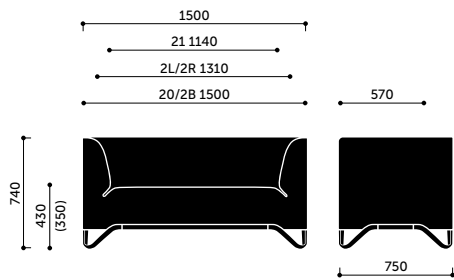

20 / 2B / 2L / 2R / 21

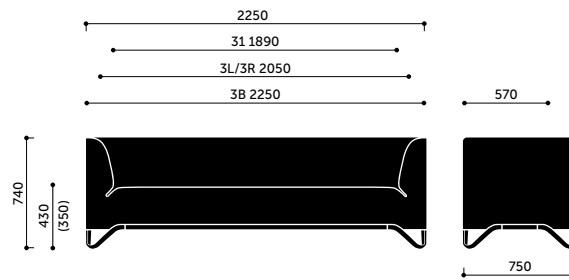

3B / 3L / 3R / 31

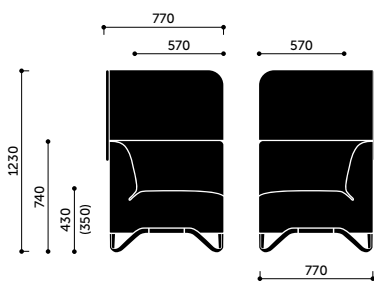
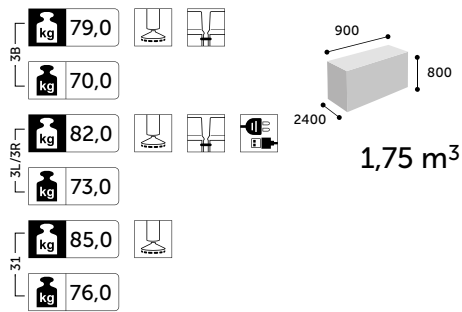
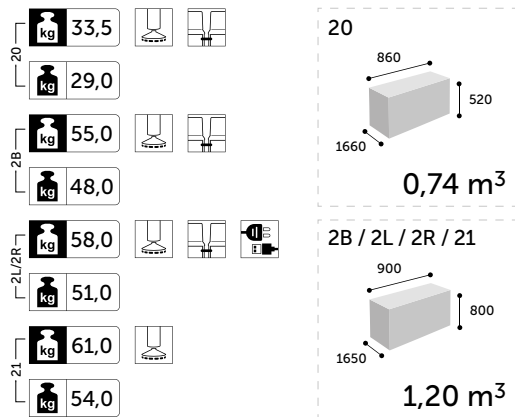

1CW

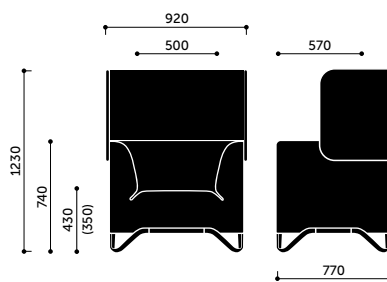

11W

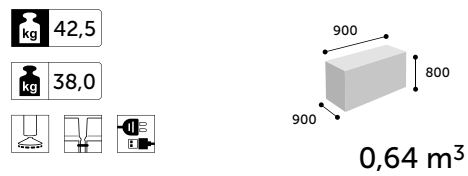

Technical details

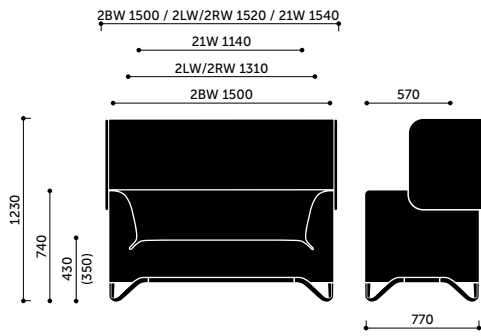

2BW / 2LW / 2RW / 21W

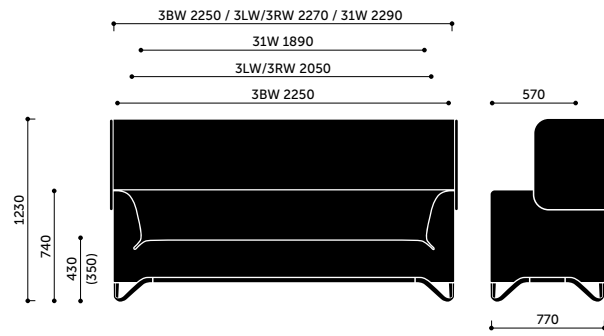

3BW / 3LW / 3RW / 31W

2BW	63,5			1650	800	900	1,20 m³
	56,5						
2LW/2RW	68,5			2400	800	900	1,75 m³
	61,5						
21W	75,5			1650	800	900	1,20 m³
	68,5						

3BW	92,5			2400	800	900	1,75 m³
	83,5						
3LW/3RW	98,0			2400	800	900	1,75 m³
	89,0						
31W	102,5			2400	800	900	1,75 m³
	93,5						

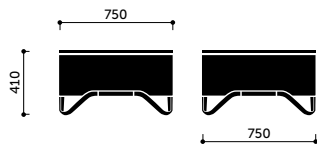

S2

27,0		860	520	860	0,40 m³
24,0					

Sorriso

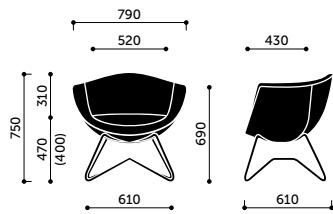

10V

17,5		810	1030	630	0,53 m³
13,5					

Technical details

Standard Folding Table

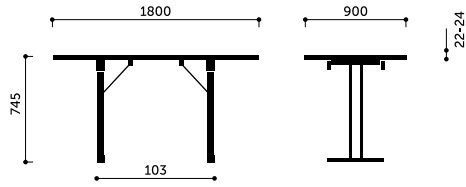

Standard Folding Table 4680-10

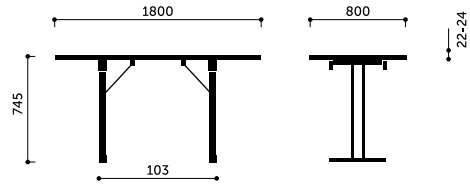

Standard Folding Table 4680-22

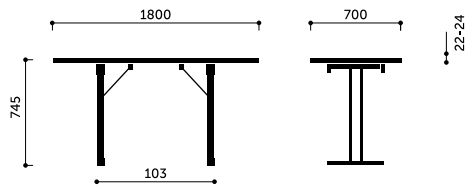

Standard Folding Table 4680-36

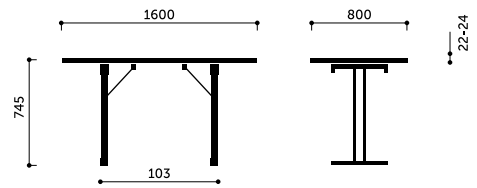

Standard Folding Table 4680-24

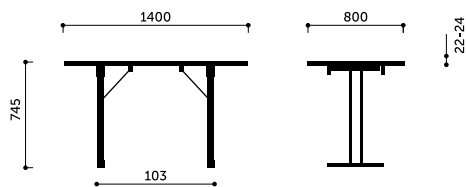

Standard Folding Table 4680-25

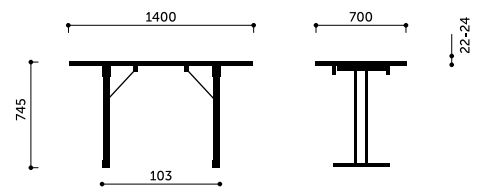

Standard Folding Table 4680-38

Technical details

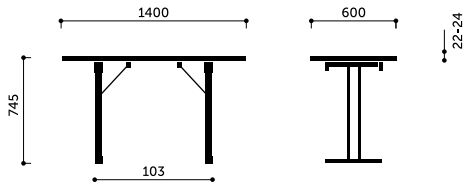

Standard Folding Table 4680-52

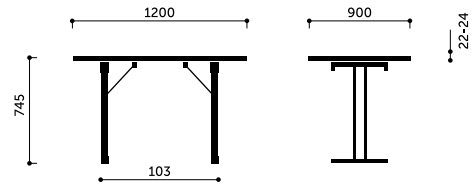

Standard Folding Table 4680-15

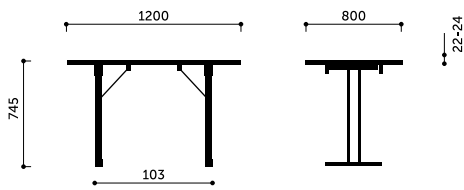

Standard Folding Table 4680-27

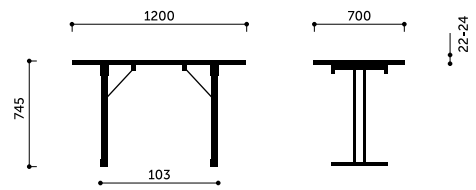

Standard Folding Table 4680-39

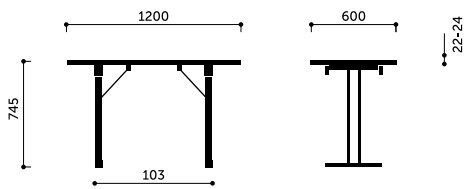

Standard Folding Table 4680-54

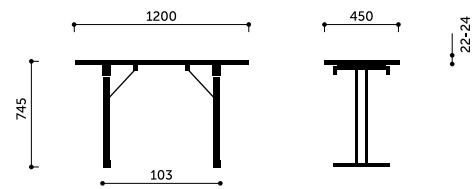

Standard Folding Table 4680-90

Technical details

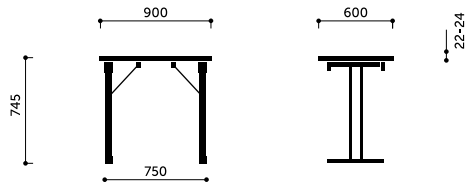

Standard Folding Table 4680-58

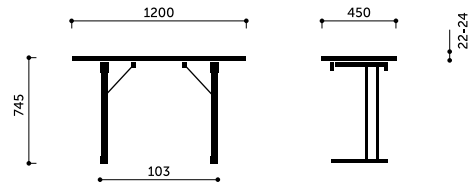

Standard Folding Table 4688-90

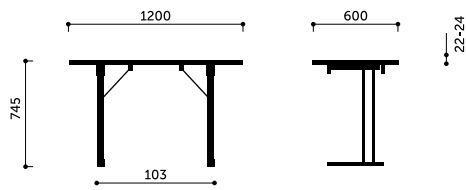

Standard Folding Table 4688-54

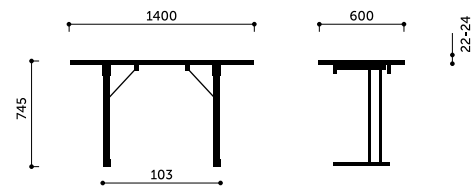

Standard Folding Table 4688-52

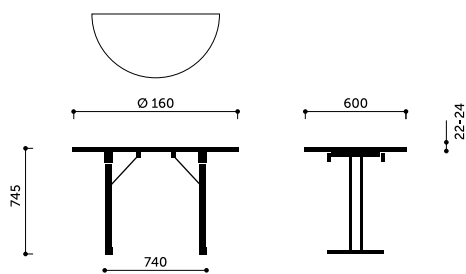

Standard Folding Table 4681-45

Technical details

Tables

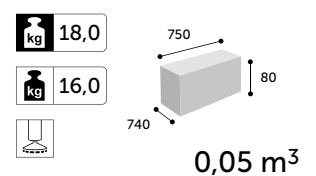
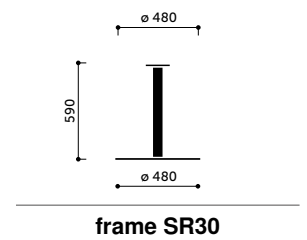
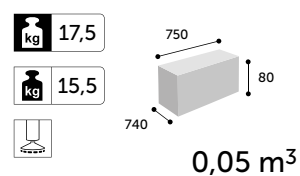
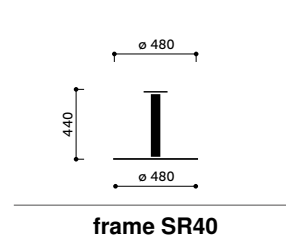
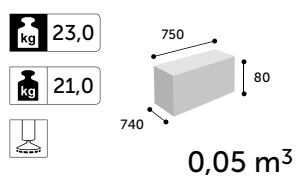
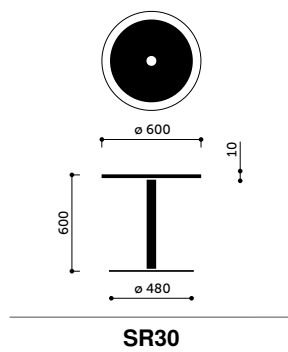
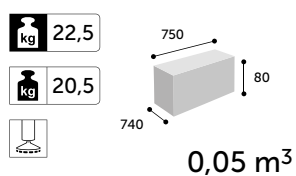
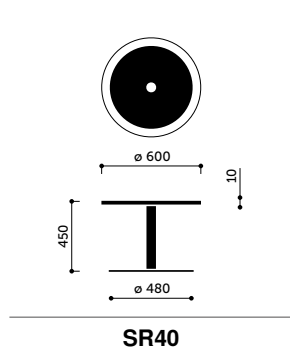
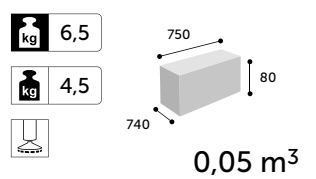
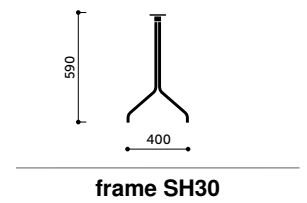
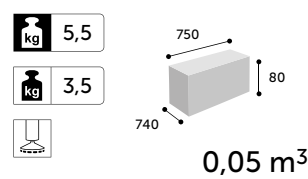
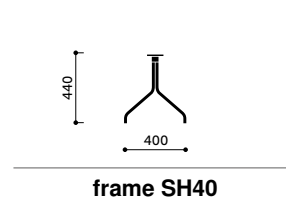
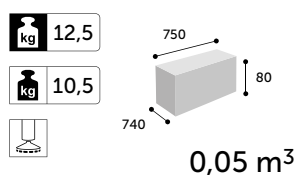
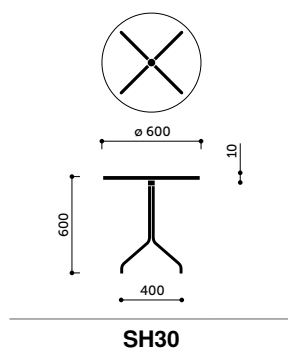
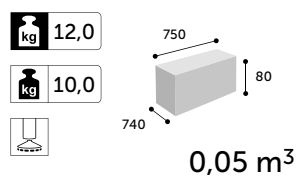
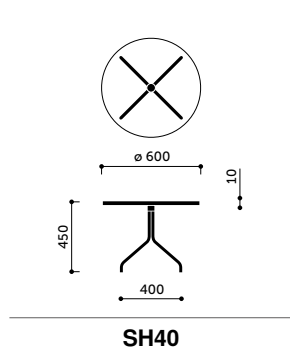
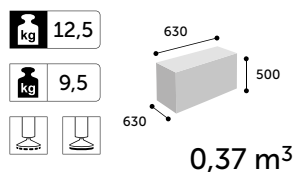
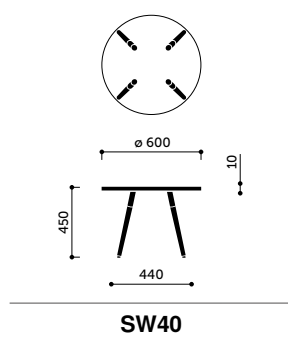
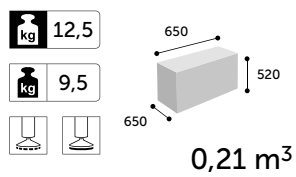
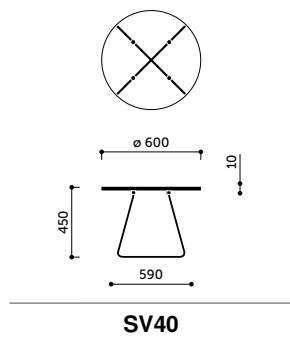

Technical details

Trillo^{Pro}

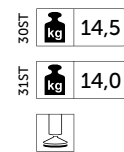
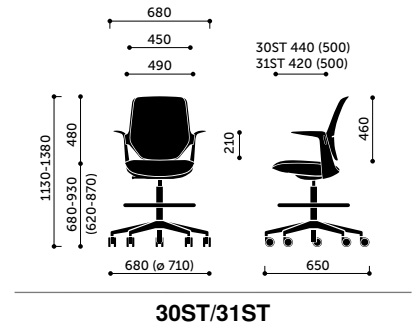
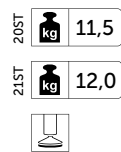
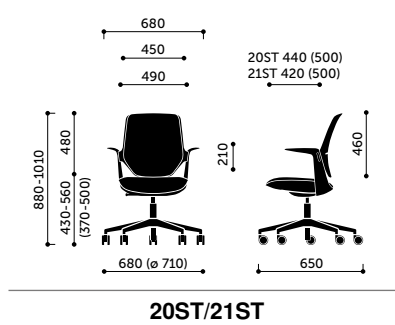
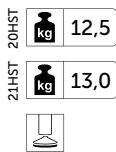
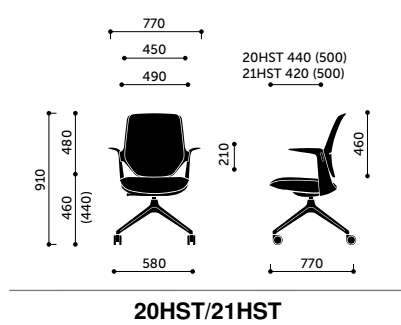

Trillo^{Pro}

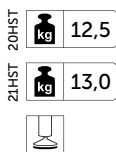
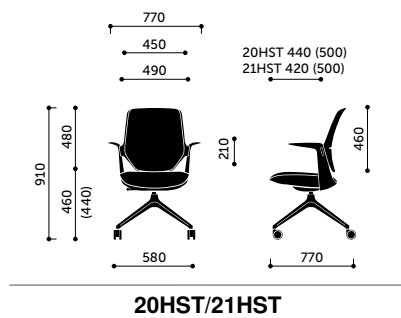

Technical details

u-Connect

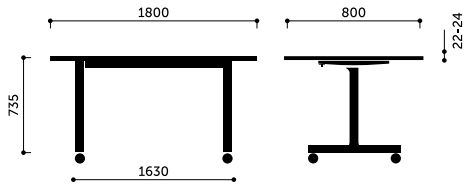

u-Connect 3490-22

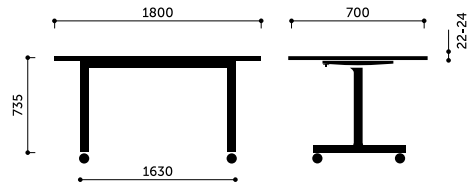

u-Connect 3490-36

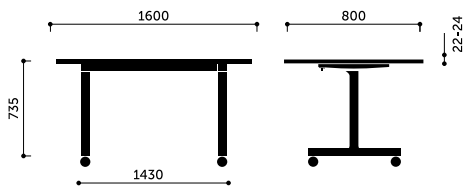

u-Connect 3490-24

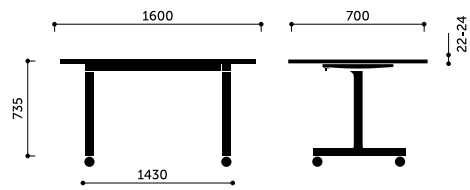

u-Connect 3490-37

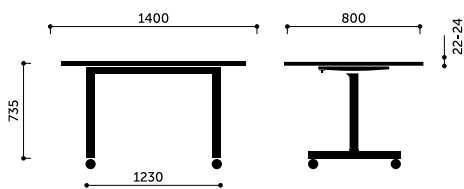

u-Connect 3490-25

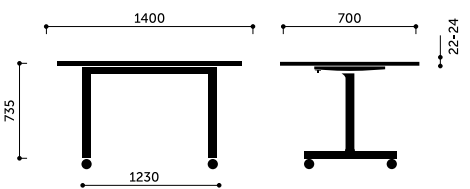

u-Connect 3490-38

Technical details

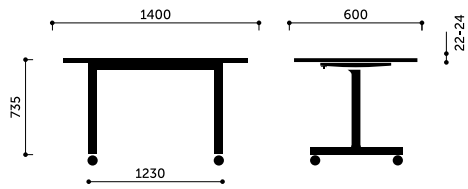

u-Connect 3490-52

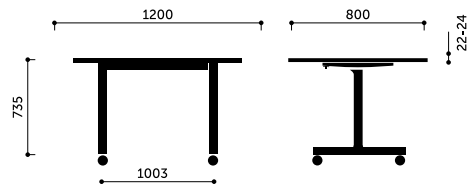

u-Connect 3490-27

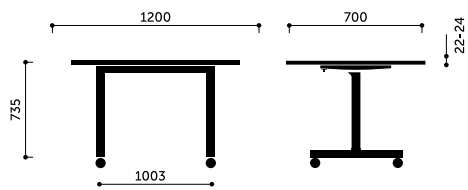

u-Connect 3490-39

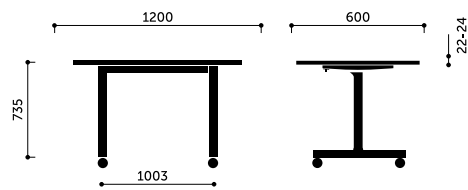

u-Connect 3490-54

Vancouver Lite

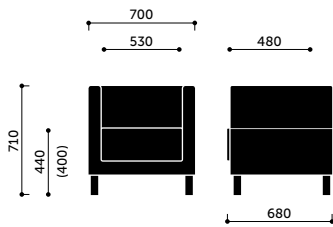

VL1 H / VL1 V

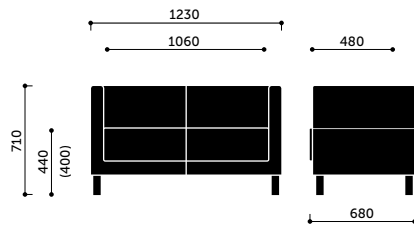

VL2 H / VL2 V

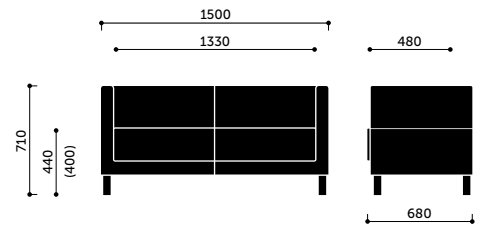

VL2,5 H / VL2,5 V

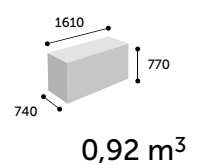
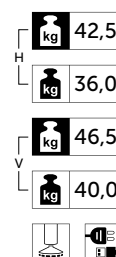
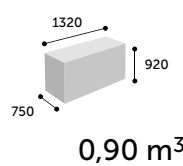
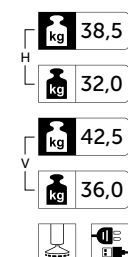
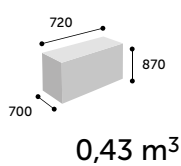
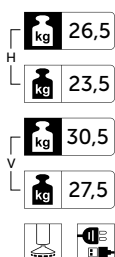

Technical details

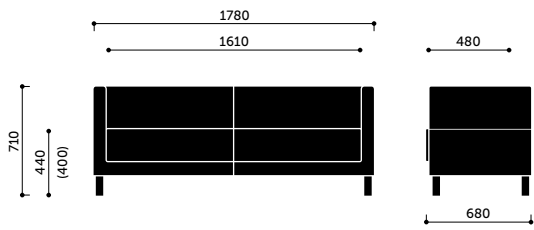

VL3 H / VL3 V

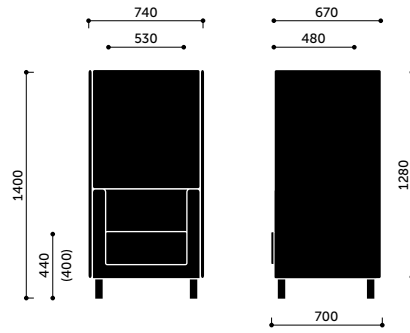

VL1 HW / VL1 VW + VL W1

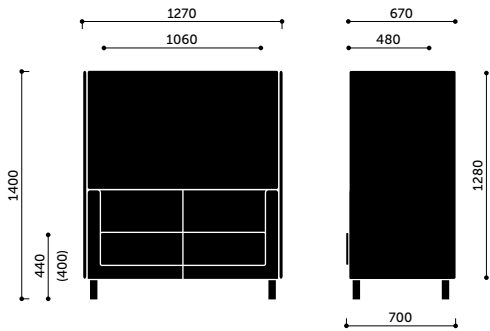
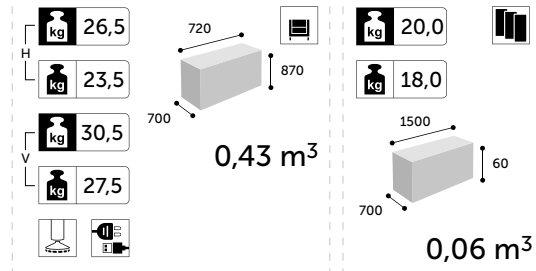
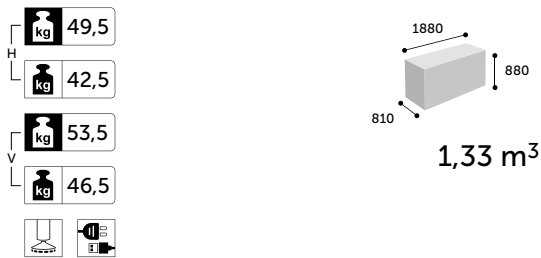

VL2 HW / VL2 VW + VL W2

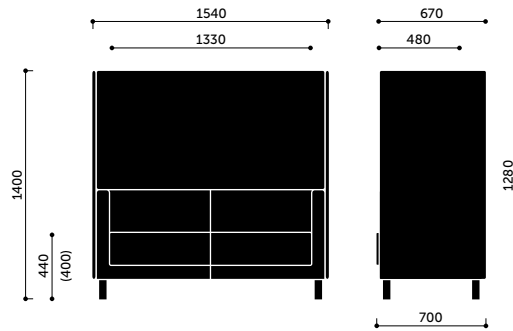

VL2,5 HW / VL2,5 VW + VL W2,5

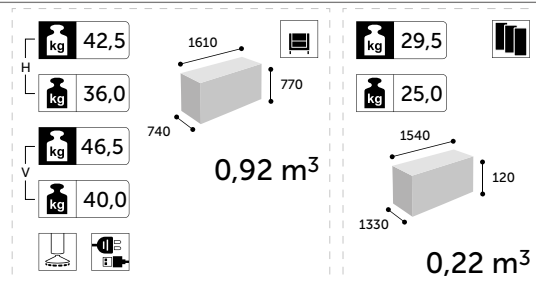
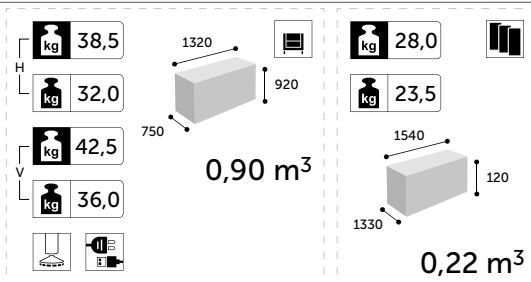

Technical details

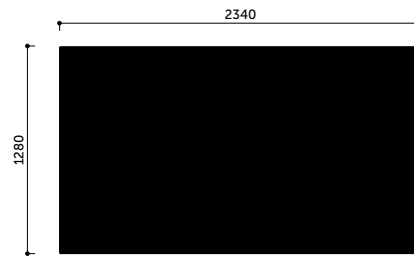
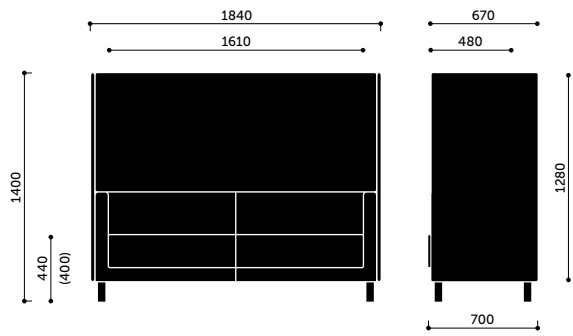

VL3 HW / VL3 VW + VL W3

VL SW / VL SW HA

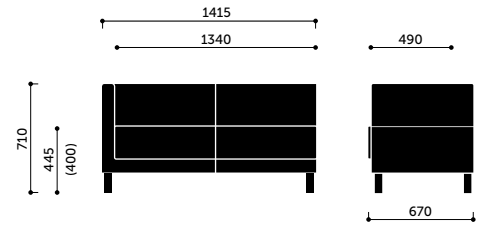
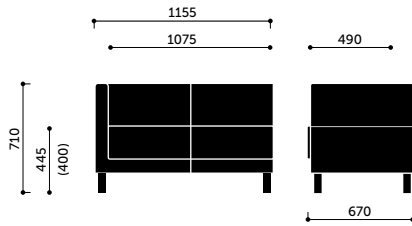
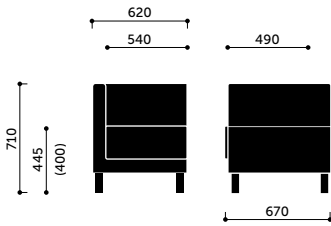
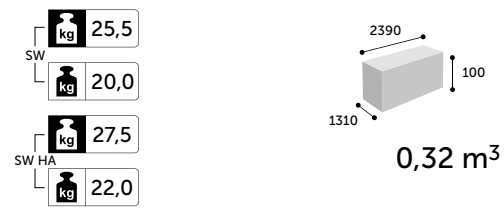
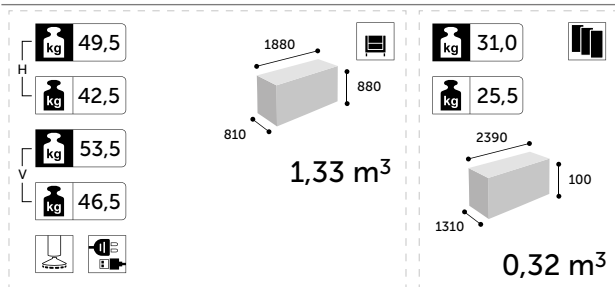

VL1L H / VL1R H

VL2L H / VL2L R

VL2,5L H / VL2,5R H

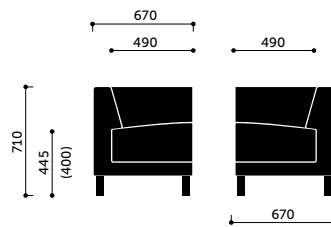
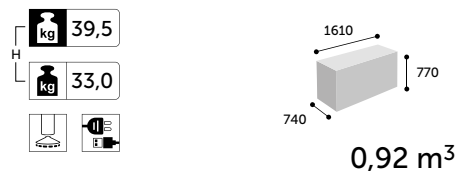
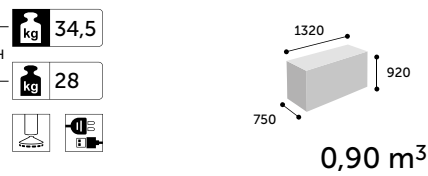
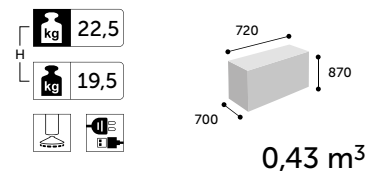

VL3L H / VL3R H

VL1C H

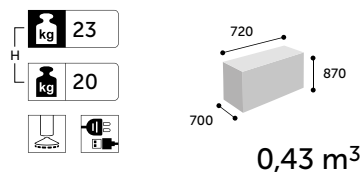

Technical details

Vancouver Oto

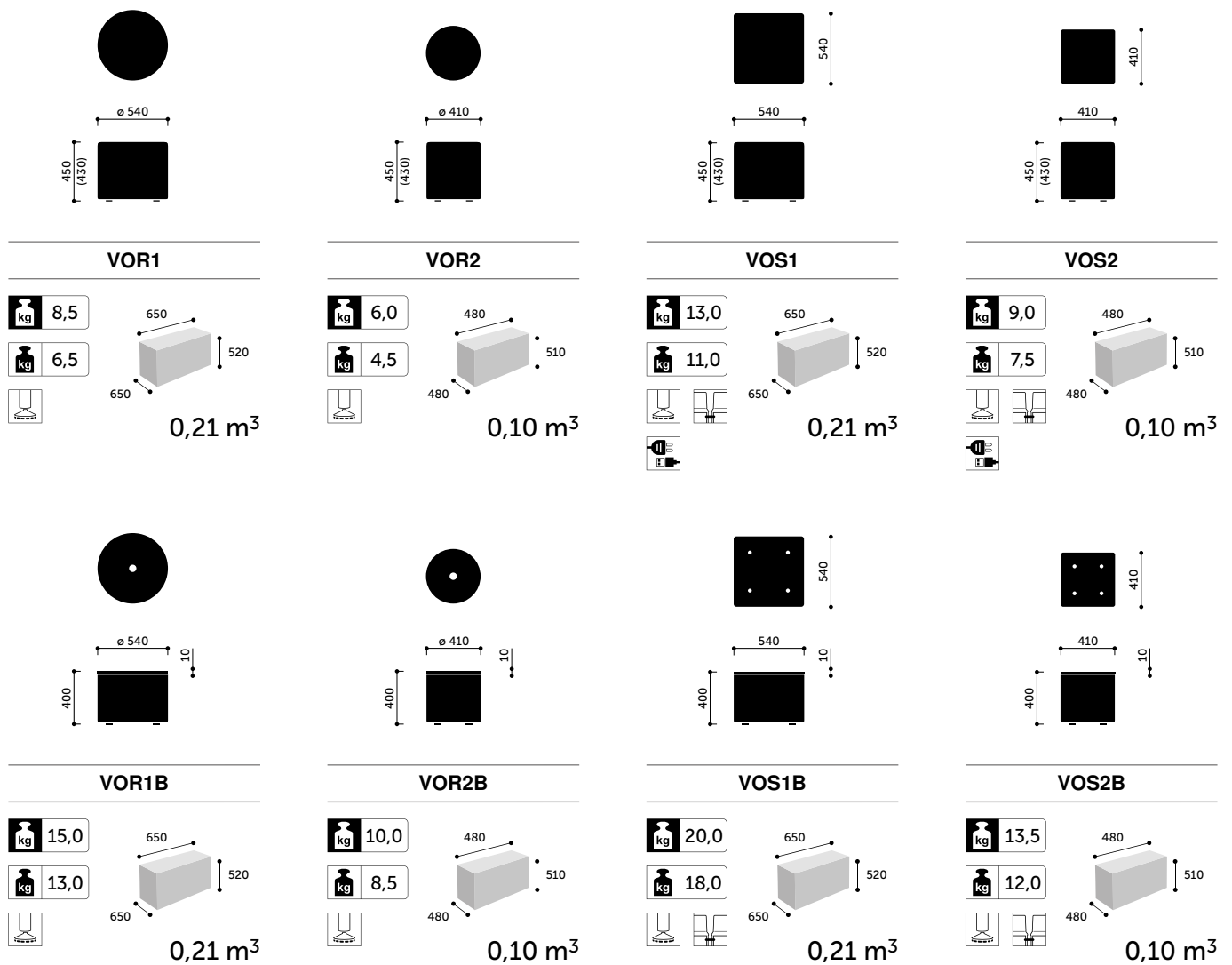

Wall In

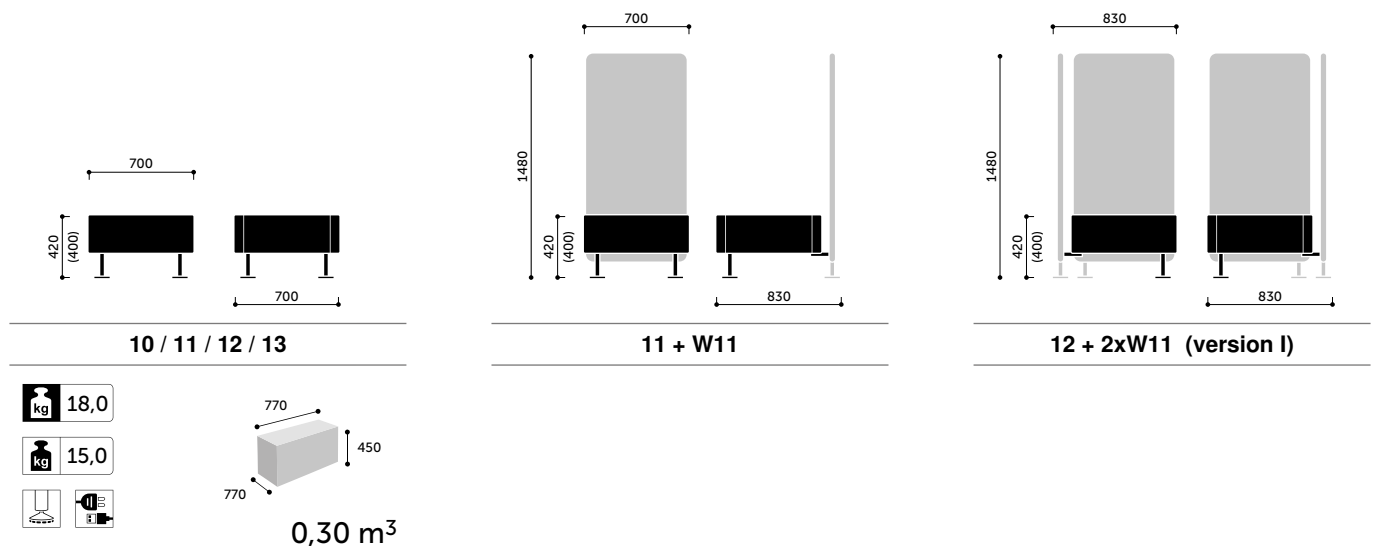

Technical details

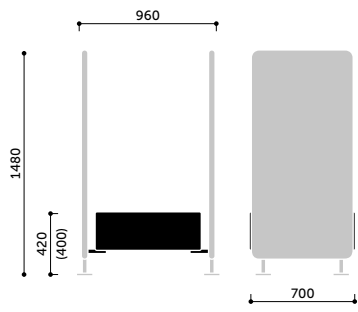

12 + 2xW11 (version II)

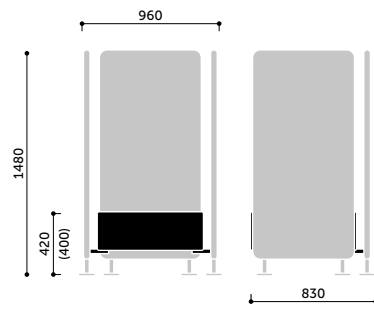

13 + 3xW11

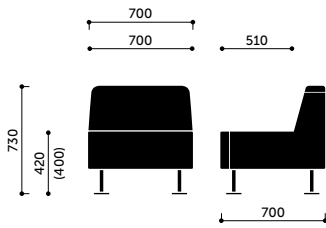

20 / 21 / 22 / 23

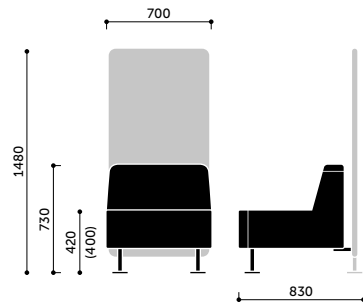

21 + W11

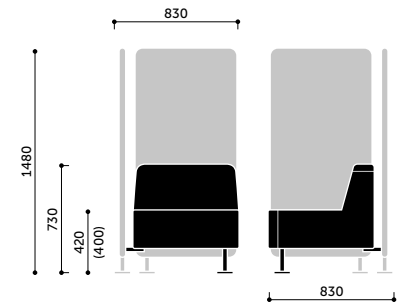

22 + 2xW11 (version I)

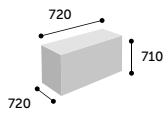
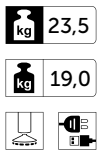

0,35 m³

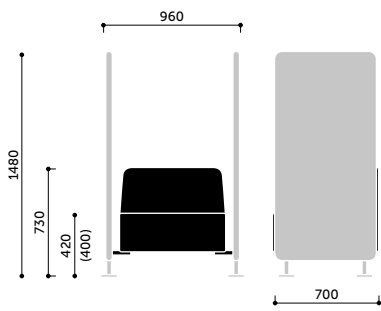

22 + 2xW11 (version II)

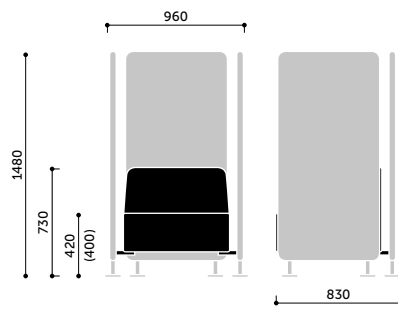

23 + 3xW11

Technical details

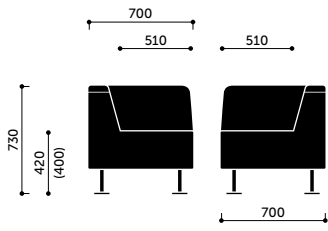

30 / 31 / 32

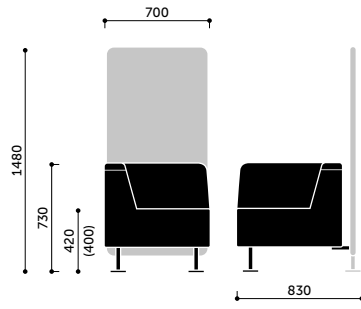

31

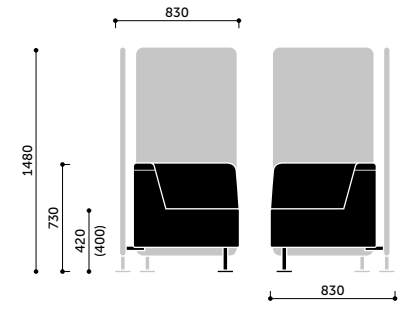

32

kg 24,5

kg 20,0

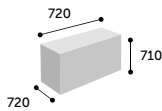

0,35 m³

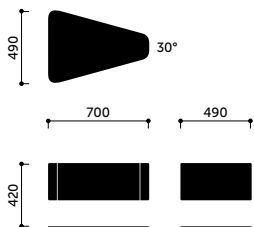

C1

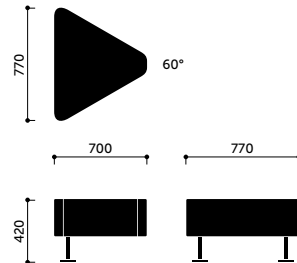

C2

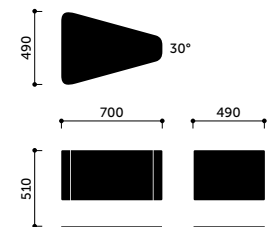

P1

kg 8,5

kg 7,0

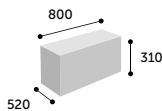

0,13 m³

kg 11,5

kg 9,0

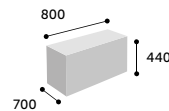

0,25 m³

kg 12,0

kg 9,5

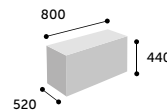

0,20 m³

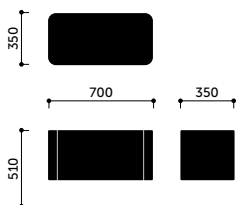

P3

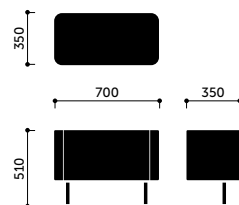

P4

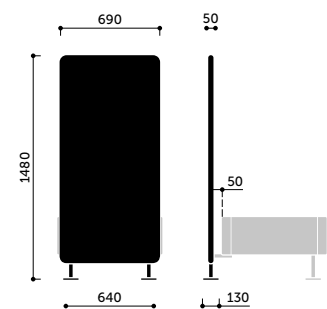

W11 / W12

kg 12,5

kg 10,0

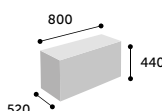

0,20 m³

kg 13,5

kg 11,0

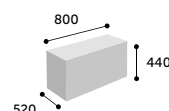

0,20 m³

kg 11,5

kg 9,5

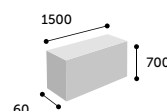

0,06 m³

Technical details

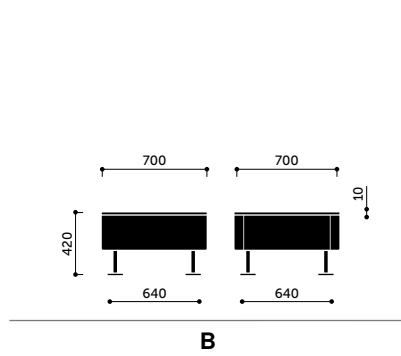

kg 28,5

kg 25,5

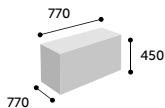

0,30 m³

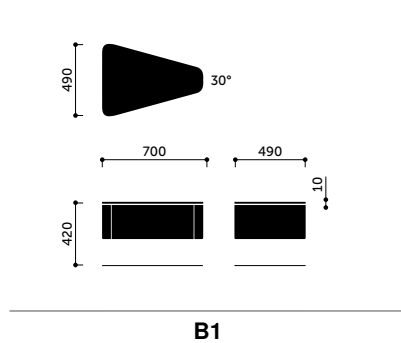
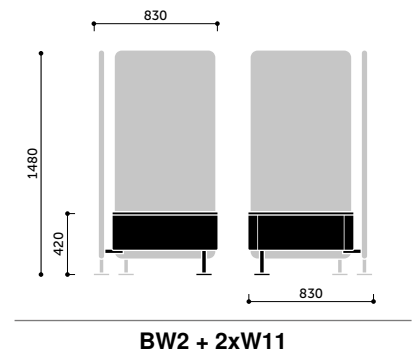
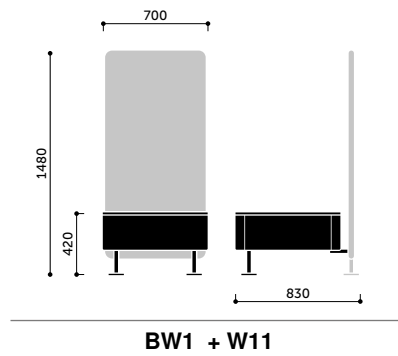

kg 14,5

kg 13,0

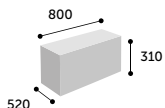

0,13 m³

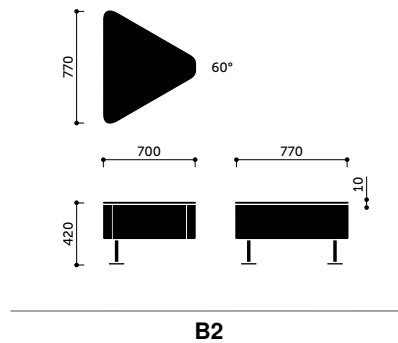

kg 20,5

kg 18,0

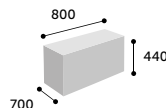

0,25 m³

Zoo

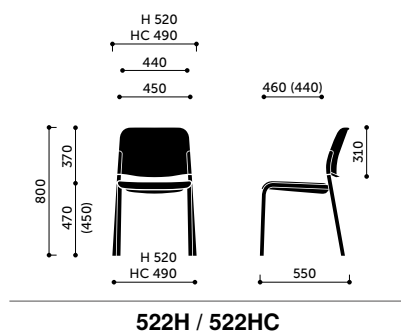

H kg 7,0

HC kg 7,5

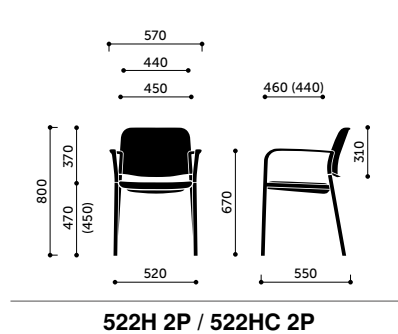
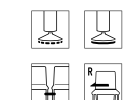

H 2P kg 8,0

HC 2P kg 8,5

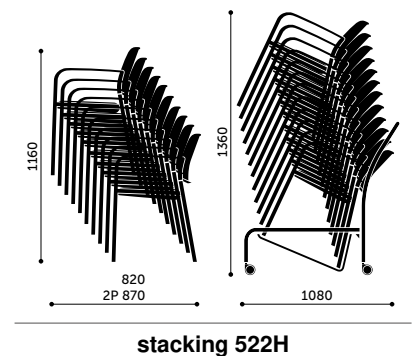
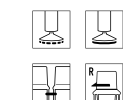

H 10 H 2P 10 H 2PB 5
H 12 H 2P 10 H 2PB 5

Technical details

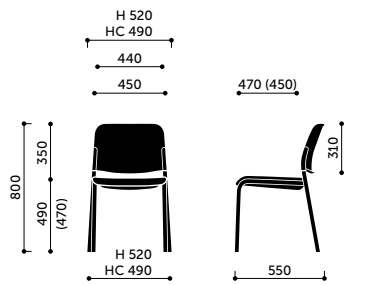

502H / 502HC

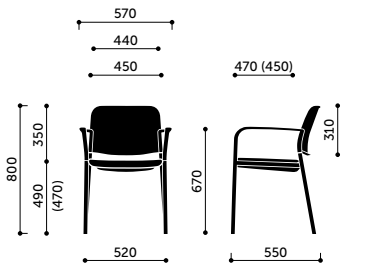
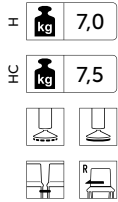

502H 2P / 502HC 2P

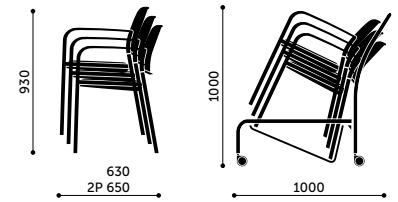
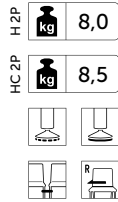

stacking 502H



* chairs upholstered in Valencia: 3 pcs.

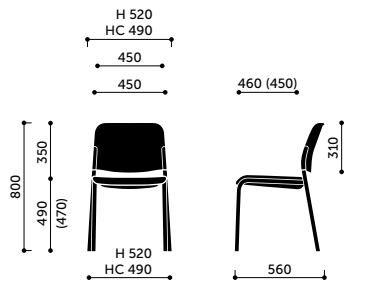

500H / 500HC

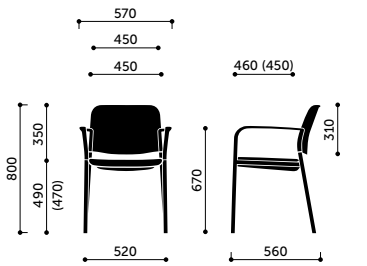
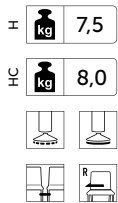

500H 2P / 500HC 2P

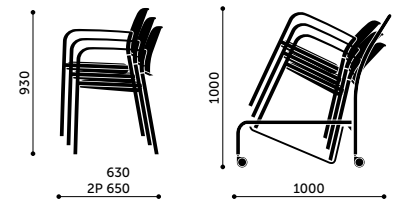
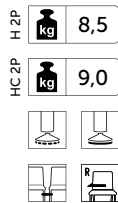

stacking 500H

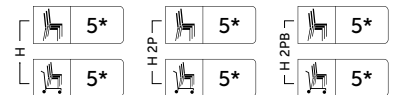

* chairs upholstered in Valencia: 3 pcs.

Castors / glides









Castors / glides	Models	Type	Castors / glides	Models	Type
	Ellie ^{Pro} , Noor, Trillo ^{Pro}	soft / hard (ø 65 mm)		Com V	felt / teflon
	Trillo ^{Pro} 30ST/31ST	soft / hard (ø 65 mm)		Chic H	felt / teflon
	Acos ^{Pro} 30VN	felt / teflon		Chic 20F, Fan 10F, Nu 20F	felt / teflon
	Acos ^{Pro} 30H	felt / teflon		Chic 20HW, Nu 20HW	felt / teflon
	Ariz - without armrests	felt / teflon		Ellie ^{Pro} 10HW, Ellie ^{Pro} 20HW	felt / teflon
	Ariz - with armrests	felt / teflon		Chic Lounge V3, Nu 20V3	felt / teflon
	Bit H	felt / teflon		Ellie ^{Pro} 10V3, Ellie ^{Pro} 20V3	felt / teflon
	Bit V, Zoo H	felt / teflon		Ellie ^{Pro} 10ST, Ellie ^{Pro} 20ST, Ellie ^{Pro} 10HST, Ellie ^{Pro} 20HST, Trillo ^{Pro} 20, Trillo ^{Pro} 21, Nu HC	teflon (ø 50 mm)
	Com H	felt / teflon		Fan 10H, Fan 10HS, Nu 20HS	felt / teflon
	Com V1	felt / teflon		Fan 10HW	felt / teflon
	Com V2	felt / teflon		Fan 10V, Fan 20V	felt / teflon
	Ana	felt / hard			

Castors / glides





Castors / glides	Models	Type
	Fan 10HC, Fan 10Z, Fan 10E, Nu 20HC	Universal (ø 65 mm)
	Com HC, Normo HC	Universal (ø 55 mm)
	Fan 10Z, Fan 10E	teflon
	Sorriso 10V	felt / teflon
	Noor 6090/6095	felt / hard
	Noor 6060/6065	felt / hard
	Noor 6050/6055	felt / hard
	Noor 6080/6085	felt / hard

Castors are equipped with a brake that prevents the chair from "moving away" without a load.
In models LightUp 330ST/350ST and Trillo^{Pro} 30ST/31ST castors are equipped with a reverse brake that prevents the chair from "moving away" with a load.

Bases

Base	Applied to the models	Colour	Type of material	Diameter (mm)
	Ellie ^{Pro} 10HST, Ellie ^{Pro} 20HST, Trillo ^{Pro} 20HST, Trillo ^{Pro} 21HST, Nu HC	black	aluminium powder coated aluminum	770
	Ellie ^{Pro} 10HST, Ellie ^{Pro} 20HST, Trillo ^{Pro} 20HST, Trillo ^{Pro} 21HST, Nu HC	white	powder coated aluminum	770
	Ellie ^{Pro} 10HST, Ellie ^{Pro} 20HST, Trillo ^{Pro} 20HST, Trillo ^{Pro} 21HST, Nu HC	graphite	powder coated aluminum	770
	Ellie ^{Pro} 10HST, Ellie ^{Pro} 20HST, Trillo ^{Pro} 20HST, Trillo ^{Pro} 21HST, Nu HC	polished aluminum	aluminium	770
	Ellie ^{Pro} 10ST, Ellie ^{Pro} 20ST	black	plastic - polyamide	710
	Ellie ^{Pro} 10ST, Ellie ^{Pro} 20ST	light grey	plastic - polyamide	710
	Noor 6070, Noor 6075	polished aluminum	aluminium	665
	Noor 6070, Noor 6075	black	aluminium	665
	Noor 6070, Noor 6075	white	aluminum	665

Bases

Base	Applied to the models	Colour	Type of material	Diameter (mm)
	Fan	black	plastic - polyamide	720
	Fan	MetallicPro	powder coated aluminum	720
	Fan	polished aluminum	aluminum	720
	Fan 10F, Nu 20F	polished aluminum	aluminium	700

Mechanisms



Rocker

Fan 10Z

A - Seat height
B - Tilt angle of the backrest and the seat

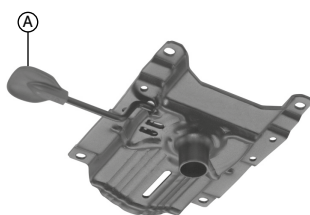

Economic

Fan 10E

A - Seat height

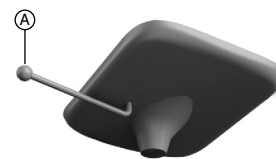

Economic

Noor 6070/6075

A - Seat height



Synchro Self*

Trillo^{Pro}, Ellie^{Pro}

A - Seat height
B - Tilt angle of the backrest and the seat



Synchro Self*

Trillo^{Pro}, Ellie^{Pro}

A - Tilt angle of the backrest and the seat

The Synchro mechanisms used in Profim products are equipped with Anti-Shock system after releasing the mechanism, the back does not hit the sitting person, but remains in the previous position. The Synchro mechanism is activated only when the person leans on the backrest again.

Linking parts

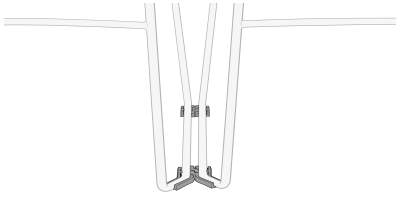

Linking part Ariz

Price - no extra charge.

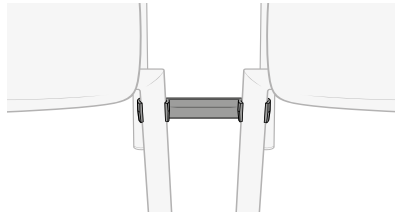

Universal FIXED 1 Linking part

Available in models without armrests: Bit.

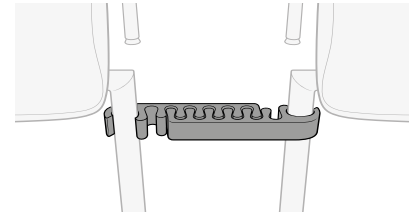

Universal ADJUSTABLE Linking part

Available in Bit without armrests.
Available in Com.

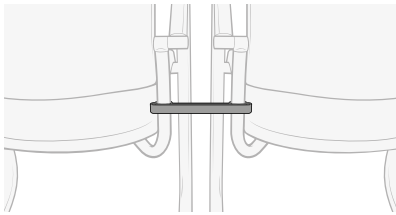

Universal FIXED 2 Linking part

Available in models: Acos^{PRO}.

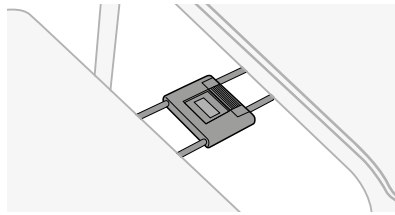

Linking part Com, Zoo

Available in 4-legged Com and Zoo.

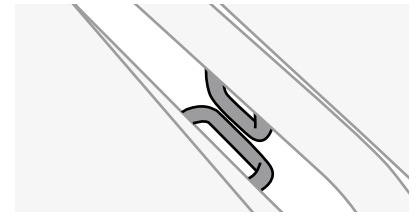

Linking part Ana

Available in Ana.

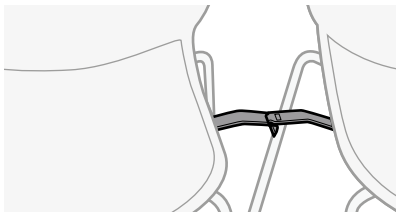

Linking part Noor

Available in Noor.

Stacking

	Maximum quantity in stack (pc.)	Maximum quantity in stack on trolley (pc.)
Acos^{Pro}		
30V	2	-
Ana		
4340	12	-
4340S	10	-
4340SR	7	-
Ariz		
550V, 555V	15	45
550V 2P, 555V 2P	10	45
560V, 560V 2P	5	20
570V, 570V 2P	5	20
575V, 575V 2P	5	20
550CV	2	-
555CV	2	-
560CV	2	-
570CV	2	-
575CV	2	-
Bit		
550H, 550H 2P	5	-
555H, 555H 2P	5	-
560H, 560H 2P	3	-
570H, 570H 2P	3	-
575H, 575H 2P	3	-
550V, 550V 2P	3	-
555V, 555V 2P	3	-
560V, 560V 2P	3	-
570V, 570V 2P	3	-
575V, 575V 2P	3	-
Com		
12H (+2P)	15	15
12H 2PB	5	5
12V1 (+2P)	5	5
12V2	5	5
12V	15	15
22H (+2P)	12	12
22H 2PB	5	5
22V1 (+2P)	5	5
22V2	5	5
22V	12	12
32H (+2P)	12	12
32H 2PB	5	5

	Maximum quantity in stack (pc.)	Maximum quantity in stack on trolley (pc.)
32V1 (+2P)	5	5
32V2	5	5
32V	12	12
42H (+2P)	10	10
42H 2PB	5	5
42V1 (+2P)	5	5
42V2	5	5
42V	10	10
Noor		
4-leg 6050/6055	10	-
4-leg 6050/6055 with armrests	10	-
4-leg 6060/6065	5	-
4-leg 6060/6065 with armrests	5	-
Normo		
H, H LP, H SP	4	-
V, V SP	4	-
Zoo		
522H	10	12
522H 2P	10	10
522H 2PB	5	5
502H, 502H 2P, 502H 2PB	5*	5*
500H, 500H 2P, 500H 2PB	5*	5*

* Chairs upholstered in Valencia - 3 pcs.

Glides, table tops, joining in rows

	Joining in rows	Felt glides (for hard surfaces)	Teflon glides (universal)	Left-sided table top	Right-sided table top
Ana	•	•		•	•
Ariz	•	•	•	•	•
Bit	•	•	•		
Chic		•	•		
Chic Lounge		•	•		
Chic Tables		•	•		
Com	•	•	•	•	
Ellie ^{Pro}		•	•		
Fan		•	•		
Mickey			•		
MyTurn Sofa		•			
Noor	•	•			
Normo		•	•		
Nu		•	•		
October		•			
Revo			•		
Revo Tables		•			
Seven					
SoftBox	•	•			
Sorriso		•	•		
Tables SH/SR/SV/SW		•	•		
Trillo ^{Pro}			•		
Vancouver Lite		•			
Vancouver Oto	•	•			
Wall In	•	•			
Zoo	•	•	•	•	

Details in additional information on specific models.

Consumption of fabric and leather

The quantities below are only estimated. The real quantity of fabric- or leather-consumption may vary in accordance to the quantity of pieces on order. Please notice that before we accept any order in customer's own material we need to make sample trials. Please be aware that not every type of fabric/leather is suitable for upholstery. Volume of customer's own material must be agreed each time with Profim sales organization

Column A - Estimated consumption of fabric (roll width: 1,40 m)

Column B - Estimated consumption of leather (m²)

	A	B		A	B		A	B
Acos^{Pro}			Ellie^{Pro}			Revo		
30H, 30HC, 30V	1,2	1,8	10	2,5	-	P40	1,5	-
			20	2,4	-	P60	2,2	-
Ariz			Fan			SW120	2,4	-
560, 575	0,6	-	10	1,4	1,9	SW180	3,2	-
570	1,6	-	20	2,4	3,3	SW240	3,9	-
Bit			cushion	0,5	0,5	SN150	2,6	-
560, 575	0,6	-	Mickey			SN210	3,3	-
570	1,0	-	seating	0,7	-	B90	1,2	-
580	1,2	-	side of the base	0,25	-	B120	1,5	-
Chic			MyTurn Sofa			B180	2,1	-
10	2,2	3,5	10	3,8	7,4	W90	2,9	-
20	1,2	1,4	20	6,0	10,0	W120	3,8	-
21	1,0	1,1	30	8,7	13,0	W180	5,6	-
Chic Lounge			Normo			SoftBox		
A10	2,2	4,0	500	1,0	-	10, S2	2,2	2,4
A20	2,1	3,3	Nu			1C	2,5	4,0
PV3	1,2	1,6	20	1,6	-	11	3,2	5,5
CU	0,4	0,3	October			20	3,0	4,0
Cushion			10	2,0	2,1	2B	4,4	6,0
CU30	0,4	-	20	3,5	4,0	2R, 2L	4,8	6,5
CU40	0,5	-	11	3,6	5,7	21	4,5	7,2
Com			21	5,5	9,2	3B	6,6	8,7
22	0,5	0,3	31	7,7	12,2	3R, 3L	5,8	8,9
32	1,0	0,7	12	6,5	8,5	31	5,9	9,6
42	1,1	1,1	22	8,0	12,5	1CW*	1,6	-
22CV	0,5	0,3	32	10,5	18,5	11W*	1,8	-
42CV	0,7	0,8				2BW*	1,7	-
						2RW*, 2LW*	2,1	-
						21W*	2,6	-
						3BW*	2,4	-
						3RW*, 3LW*	2,9	-
						31W *	3,3	-

*refers only to screens

Consumption of fabric and leather

	A	B		A	B
Sorriso			Wall In		
10	2,1	2,6	10, 11, 12, 13, B	1,5	2,0
Trillo^{Pro}			20, 21	1,8	2,7
20	0,6	-	22, 23	1,8	2,7
21	1,2	-	30, 31, 32	2,3	3,2
Vancouver Lite			C1, B1	1,6	1,4
1 H/V	2,6	4,1	C2, B2, P1	1,6	1,7
2 H/V	3,6	5,9	P3, P4	1,2	1,7
2,5 H/V	4,0	6,7	W	1,7	-
3 H/V	5,1	8,4	Zoo		
1 HW/VW	1,9	3,2	502	0,7	-
2 HW/VW	2,6	4,8	500	1,1	-
2,5 HV/VW	2,9	5,5			
3 HV/VW	3,5	6,5			
W1	6,7	-			
W2	6,7	-			
W2,5	8,9	-			
W3	8,9	-			
SW	5,5	-			
Vancouver Oto					
R1, R1B	1,2	1,6			
R2, R2B	1,0	1,1			
S1, S1B	1,8	2,6			
S2, S2B	1,1	1,3			

Quilting

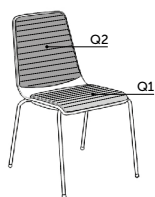

Bit / Com

Q1 - quilting on the seat pad
Q2 - quilting on the backrest pad

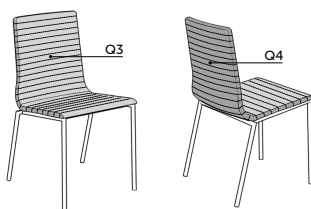

Acos^{Pro} / Com

Q3 - quilting on the whole front part
Q4 - quilting on the whole rear part



Nu / Sorriso

Q5 - quilting on the seat cushion

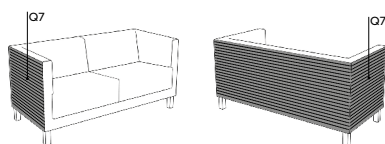

MyTurn Sofa / Vancouver Lite

Q7 - quilting on the outer part of the sides and the back

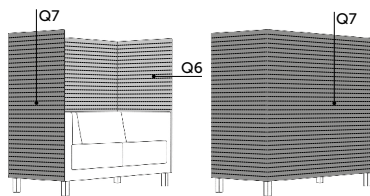

Vancouver Lite

Q6 - quilting on the inner part of the wall
Q7 - quilting on the outer part of the wall

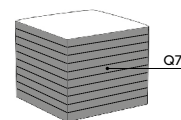

Vancouver Oto

Q7 - quilting on all of the sides

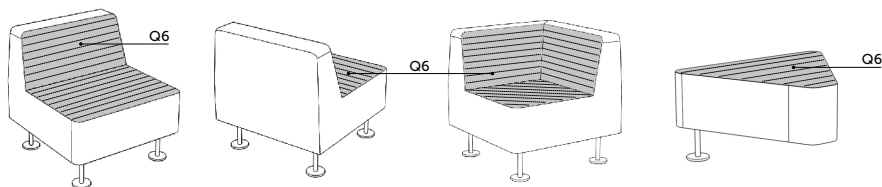

Wall In

Q6 - quilting on the seat and backrest

Measuring methodology

Swivel armchairs and chairs are measured with a mechanism adjusted in such a way that the seat is as much as it is possible positioned levelly, while the backrest vertically. Swivel armchairs and chairs are measured on their castors, whereas visitor and reception chairs on hard glides. The measurements are approximate and can differ depending on the product configuration.

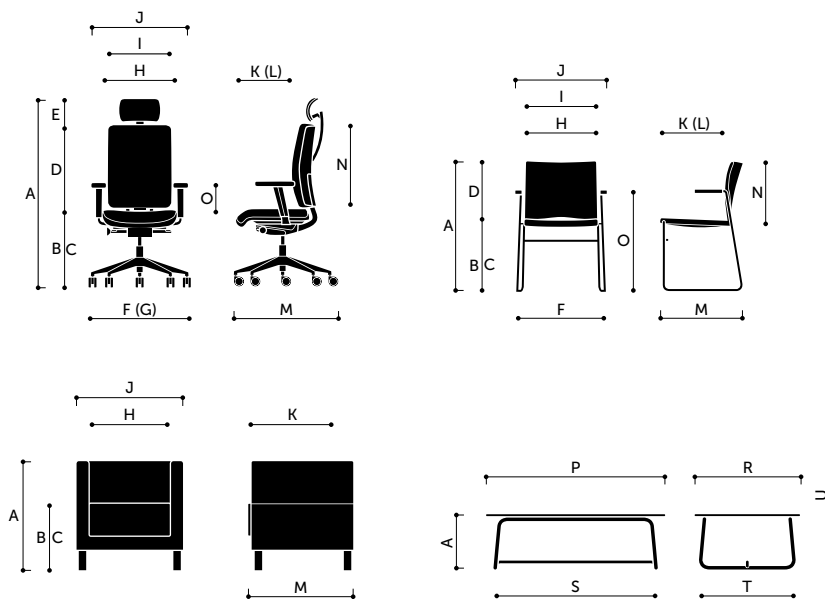

A - Total height

For products fitted with a gas lift - it is measured with gas lift's minimum and maximum extension. For products fitted with an additional backrest and headrest height adjustment - it is measured in both minimum and maximum positions of the backrest, headrest and gas lift.

B - Seat height

Measured at the highest point of the seat. For products fitted with a gas lift - it is measured with absorber's minimum and maximum extension.

C - Seat height with the burden

Seat measured according to EN standards (with seat burden). For products fitted with a gas lift - it is measured with gas lift's minimum and maximum extension.

D - Backrest height

Measured from the seat to the backrest upper edge. For products with adjustable backrest height - it is measured in the minimum and maximum position.

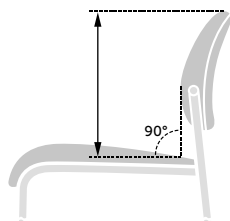

E - Headrest height

Measured from the backrest upper edge to the headrest upper edge. The headrest adjusted in maximum vertical position in relation to the upper and lower edge of the headrest. Measured in the headrest's minimum and maximum position.

F - Base, frame width

Measured at the uttermost points of the base according to the following figures.

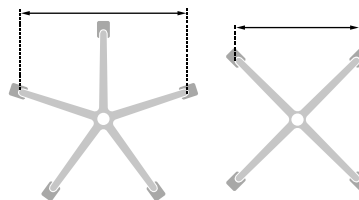

G - Base diameter

Measured according to the figure underneath.

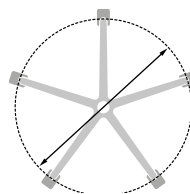

H - Seat width

Measured at the uttermost points of the seat.

I - Backrest width

Measured at the uttermost points of the backrest.

J - Total width

Measured at the uttermost points. For products fitted with adjustable armrests - it is measured with the armrests slid apart to maximum. For products fitted with armrests with adjustable pads - it is measured with the pads slid apart to maximum.

Measuring methodology

K - Seat depth

Measuring the distance between the uttermost point on the seat and the point it touches the backrest (the contact point is determined with a level positioned vertically to the backrest by projecting the S point from the backrest onto the seat) (1). For some shell chairs, where there is no distinct border-line between the seat and the backrest, the depth is measured on the bend halfway between the seat and the backrest (2). For products with additional adjustable seat depth - it is measured with minimum and maximum slide.

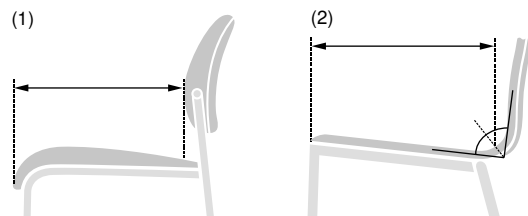

L - Seat (element) length

Measured at the uttermost points of the seat.

M - Total depth

Measured at the uttermost points. Swivel armchairs and chairs are measured according to the drawing underneath. For products with adjustable seat depth - it is measured with minimum and maximum slide.

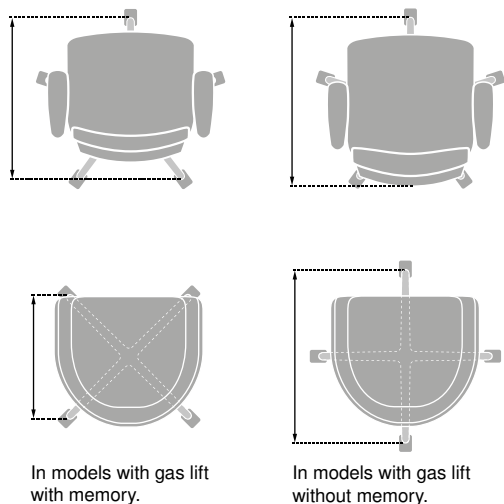

N - Backrest (element) length

Measured at the uttermost points of the backrest.

O - Armrest height

For swivel armchairs and chairs – it is measured from the seat surface to the armrest upper edge. For armrests with adjustable height – it is measured in the minimum and maximum position. For visitor chairs – it is measured from the floor to the armrest upper edge.

P - Table top length

Measured at the uttermost points of the table top.

R - Table top width

Measured at the uttermost points of the table top.

S - Table frame length

Measured at the uttermost points of the table frame.

T - Table frame width

Measured at the uttermost points of the table frame.

U - Table top thickness

Table top (element) thickness is measured.

Fabrics and finishings

Profim Standard fabrics

EVO - PRICE GROUP 0

Evo is a uni-coloured polyester crepe fabric. The irregular weave structure add shine and good stretch.

Composition: 100% polyester

Weight: 320 g/m²

Abrasion resistance: 180 000 Martindale (EN ISO 12947-2)

Flammability: BS EN 1021: 1-2 (Cigarette & match)

Light fastness: 4-5 (EN ISO 105-B02)

Rubbing fastness: 4-5 (Wet/Dry) (EN ISO 105-X12)

Pilling resistance: 5 (EN ISO 12945-2)

Environmental facts: EU Ecolabel, Oeko-Tex® Standard 100, ISO 14001 certified company

Design: Miranda Design Team

Produced in: Poland

Cleaning & disinfection: Dry cleaning with tetrachloroethylene and water solution of carbonate fluoride

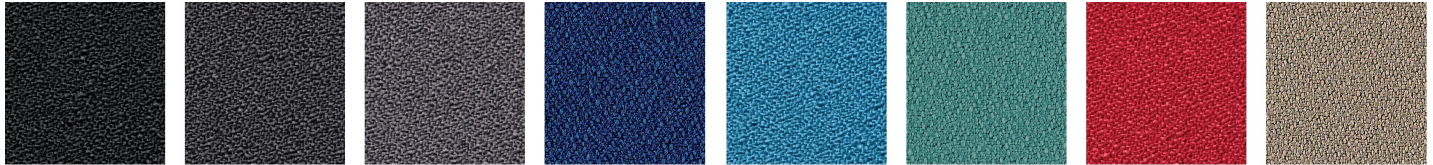

EVO011

EVO001

EVO014

EVO010

EVO025

EVO024

EVO005

EVO002

CURA (GABRIEL) - PRICE GROUP 1

Cura is a two-coloured fabric made from 100% post-consumer recycled polyester. It has a matt, slightly irregular and natural-looking texture where the dark, underlying grey fibers create a discreet yet vibrant melange effect. High durability and stretchability and its soft, voluminous touch make Cura suitable for both office and lounge furniture.

Composition: 100% post-consumer recycled polyester

Weight: 420 g/m²

Abrasion resistance: 100 000 Martindale (EN ISO 12947-2)

Flammability: BS EN 1021: 1-2, BS 5852 0&1, CA TB 117-2013, ASTM E 84 Class I

Light fastness: 5-8 (EN ISO 105 - B02)

Rubbing fastness: 4-5/4-5 (Wet/Dry) (EN ISO 105X12)

Pilling: 4-5 (EN ISO 12945-2)

Environmental facts: EU Ecolabel, Oeko-Tex® Standard 100, Contains no Flame Retardant chemicals, ISO 14001 certified company

Design: Cenk Kivrikoglu

Produced in: Lithuania

Cleaning: Wash or dry cleaning, Can be disinfected with ethanol and is bleach-cleanable (For further info follow Gabriel´s cleaning guidelines - www.gabriel.dk)



CU60999

CU60109

CU60110

CU61168

CU66165

CU66170

CU66167

CU68182

CU68186

CU62083

TONAL (GABRIEL) - PRICE GROUP 1

Tonal is a post-consumer recycled polyester fabric in a two-coloured melange. It has a discreet textured look with a fusion of light and dark tones adding depth to the colours.

Composition: 99% post-consumer recycled polyester, 1% polyester

Weight: 315 g/lm

Abrasion resistance: 100 000 Martindale (EN ISO 12947-2)

Flammability: BS EN 1021: 1-2, BS 476 Part 7 class 1, CA TB 117-2013, ASTM E 84 Class I

Light fastness: 6-8 (EN ISO 105 - B02)

Rubbing fastness: 4-5/4-5 (Wet/Dry) (EN ISO 105X12)

Pilling: 4-5 (EN ISO 12945-2)

Environmental facts: EU Ecolabel, Oeko-Tex® Standard 100, Contains no Flame Retardant chemicals, ISO 14001 certified company

Design: Cenk Kivrikoglu

Produced in: Lithuania

Cleaning: Wash or dry cleaning. Can be disinfected with ethanol and is bleach-cleanable (For further info follow Gabriel's cleaning guidelines - www.gabriel.dk)

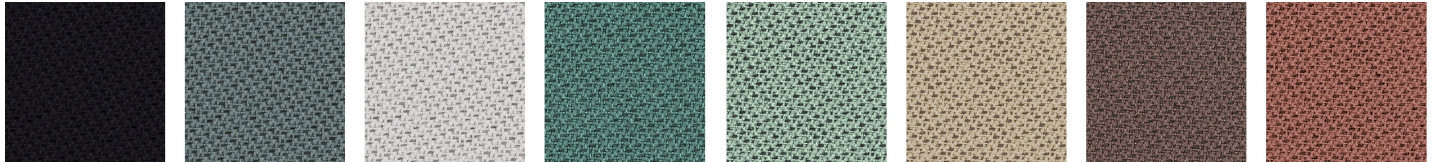

TL60999

TL60124

TL60122

TL67090

TL67089

TL61180

TL64211

TL64210

XTREME (CAMIRA) - PRICE GROUP 1

Xtreme is a crepe fabric made from 100% post-consumer recycled polyester that features exceptional Euro flammability performance. Extra stretch and structure gives an irregular, shiny finish.

Composition: 100% post-consumer recycled polyester

Weight: 310 g/m²

Abrasion resistance: >100 000 Martindale (EN ISO 12947-2)

Flammability: BS EN 1021: 1-2 (Cigarette & match), BS 7176 Low & Medium Hazard, BS 5852 Section 4 Crib 5, DIN 4102 B1, UNI 9175 Class 1 IM, NF D 60-013

Light fastness: 6 (EN ISO 105 - B02: 2013)

Rubbing fastness: 4/4 (Wet/Dry) (EN ISO 105X12)

Pilling: 5 (EN ISO 12945-2)

Environmental facts: EU Ecolabel, Oeko-Tex® Standard 100, Indoor Advantage™ "Gold", non metallic dyestuffs, ISO 14001 certified company.

Design: Camira Design Studio

Produced in: United Kingdom

Cleaning & disinfection: Washable to 60°C and bleach cleanable (For further info follow Camira's cleaning guidelines - www.camirafabrics.com)

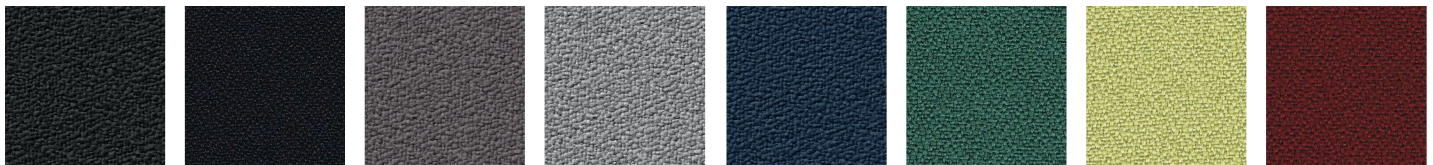

EXR009

EXR145

EXR081

EXR094

EXR026

EXR047

EXR096

EXR136

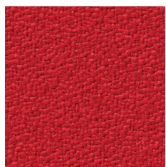

EXR079

SELECT (GABRIEL) - PRICE GROUP 2

Select is a classic woolen fabric with a tightly woven relief structure, combining excellent softness, stretch and durability. Its rich texture with the interplay of light and shadow add depth in all the colours in the palette.

Composition: 85% New Zealand wool, 15% polyamide

Abrasion resistance: 200 000 Martindale (EN ISO 12947-2)

Flammability: BS EN 1021: 1-2, BS 5852 0&1, BS5852 Crib 5, CA TB 117-2013, IMO MSC 307(88) Annex 1 part 8/MED registration IMO

Light fastness: 5-8 (EN ISO 105 - B02)

Rubbing fastness: 4-5/4-5 (Wet/Dry) (EN ISO 105X12)

Pilling: 4 (EN ISO 12945-2)

Environmental facts: EU Ecolabel, Oeko-Tex® Standard 100, 100% free of heavy metals, ISO 14001 certified company

Design: Cenk Kivrikoglu

Produced in: Lithuania

Cleaning: Professional dry cleaning (For further info follow Gabriel's cleaning guidelines - www.gabriel.dk)

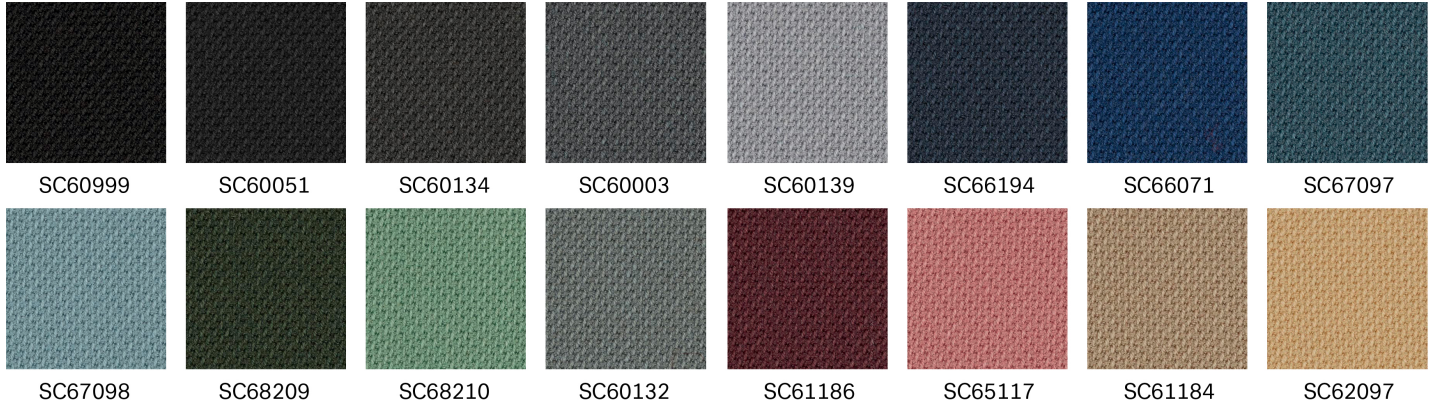

CAPTURE (GABRIEL) - PRICE GROUP 3

Capture is a lightly felted and multi-coloured wool fabric combining softness, stretch and strenght. It fuses light and dark colours to a refined melange pattern in subtle nuances, which add richness and depth to the design.

Composition: 85% New Zealand wool, 15% polyamide

Abrasion resistance: 200.000 Martindale (EN ISO 12947-2)

Flammability: BS EN 1021: 1-2 (Cigarette & match), BS 5852 Part 1 0,1 (Cigarette & match), CA TB 117-2013, Class Uno UNI 9175 Class 1 IM

Light fastness: 5-7 (EN ISO 105-B02)

Rubbing fastness: 4-5/4-5 (Wet/Dry) (EN ISO 105X12)

Pilling: 4-5 (EN-ISO 12945-2)

Environmental facts: EU Ecolabel, Oeko-Tex® Standard 100, 100% free of heavy metals, ISO 14001 certified company

Design: Cenk Kivrikoglu

Produced in: Lithuania

Cleaning: Professional dry cleaning (For further info follow Gabriel's cleaning guidelines - www.gabriel.dk)

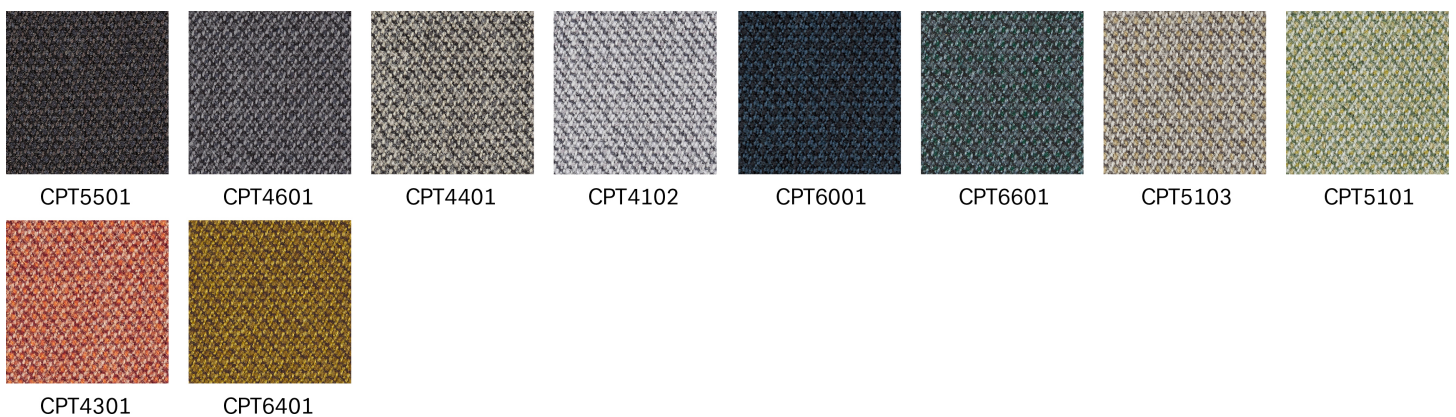

OCEANIC (CAMIRA) - PRICE GROUP 3

Oceanic is made from 100 % post-consumer recycled polyester yarn where 90% are created from post-consumer plastic bottles diverted from landfill and 10% is upcycled marine plastic(from marine litter). It is a fabric born out of the SEAQUAL Initiative designed to combat marine plastic pollution and achieve a waste free environment. Oceanic has a two coloured diagonal structure with a matte surface and soft touch.

Composition: 100 % post-consumer recycled polyester, including 50% SEAQUAL yarn

Weight: 497 g/m² ±5%

Abrasion resistance: >100 000 Martindale (EN ISO 12947-2)

Flammability: BS EN 1021: 1-2 (Cigarette & match), BS 7176 Low, BS 7176 Medium Hazard with EnviroFlam5, CA TB 117-2013

Light fastness: 5 (EN ISO 105 - B02: 2013)

Rubbing fastness: 4/4 (Wet/Dry) (EN ISO 105X12)

Pilling: 4 (EN ISO 12945-2)

Environmental facts: EU Ecolabel, Oeko-Tex® Standard 100, Indoor Advantage™ "Gold", non metallic dyestuffs, ISO 14001 certified company.

Design: Camira Design Studio

Produced in: United Kingdom

Cleaning & disinfection: Washable at 60 °C and bleach cleanable (For further info follow Camira´s cleaning guidelines – www.camirafabrics.com)

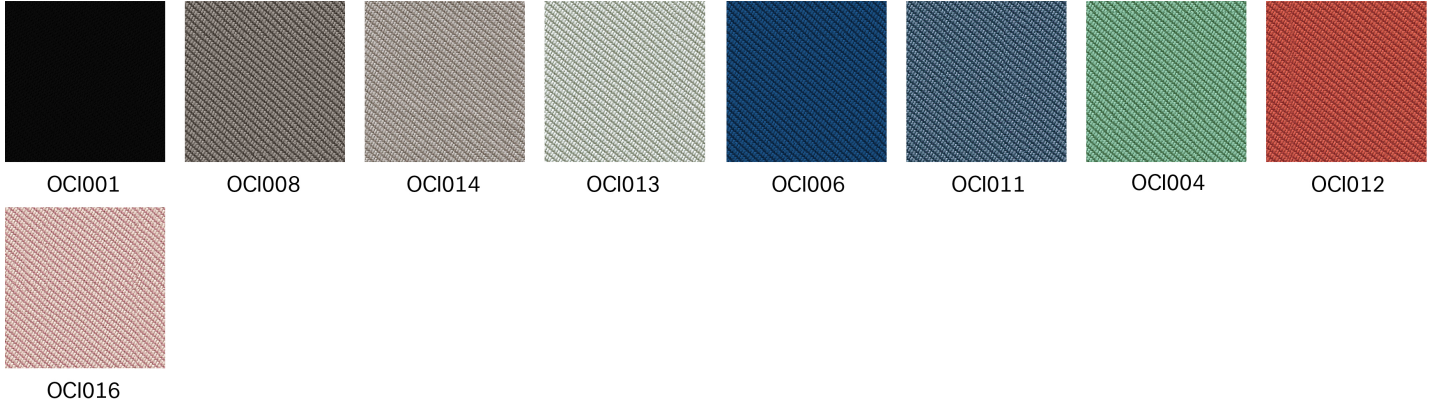

STEP (GABRIEL) - PRICE GROUP 3

Step is unique in both texture and performance. With its delicate surface, Step is perceived as vivid and interesting. The texture with the fire-resistant Trevira CS yarn ensures that the fabric is suited for use in environments with high fire safety and durability requirements.

Composition: 100% Trevira CS

Weight: 336 g/m²

Composition: 100% Trevira cs

Abrasion resistance: 100 000 Martindale (EN ISO 12947-2)

Flammability: BS EN 1021: 1&2 (Cigarette & match), BS 5852 0&1 (Cigarette & match), BS 5852 Crib 5, CA TB 117-2013, MED Certificate IMO, Class Uno UNI 9175 Class 1 EMME, ÖNORM

Light fastness: 5-7 (EN ISO 105 - B02)

Rubbing fastness: 4-5/4-5 (Wet/Dry) (EN ISO 105X12)

Pilling: 4-5 (EN ISO 12945-2)

Environmental facts: EU Ecolabel, Oeko-Tex® Standard 100, 100% free of heavy metals, ISO 14001 certified company

Design: Inger Mosholt Nielsen

Produced in: Lithuania

Cleaning: Professional dry cleaning (For further info follow Gabriel's cleaning guidelines www.gabriel.dk)

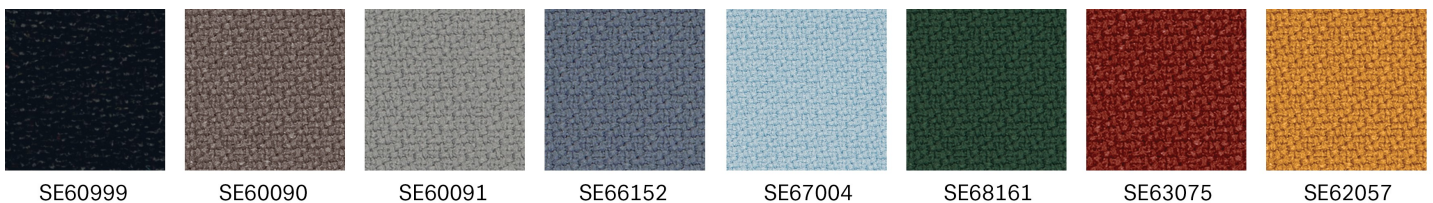

SYNERGY (CAMIRA) - PRICE GROUP 3

Epitomising natural simplicity, Synergy is a wool rich fabric which is at once both irresistibly soft and ultra-high performing. Delicately felted, with a beautifully relaxed drape, the understated aesthetics showcase the intriguing coloration of this considered textile.

Composition:

- 95% wool
- 5% polyamide
- **Weight:** 400 g/m²

Certificates:

- **Abrasion resistance:** 100000 Martindale cycles (BS-EN ISO 12947-2)
- **Pilling resistance:** 4 (BS-EN ISO 12945-2)
- **Flammability:** cigarette (BS-EN 1021-1)
- **Flammability:** match (BS-EN 1021-2)
- **Flammability:** (UNI 9175 Class 1IM)
- **Light fastness:** 5 (ISO 105-B02)
- **Maintenance:**
 - -vacuum regularly
 - -use dry-clean preparations
 - -do not bleach

Because of the fact that the fabric Synergy is composed of 95% natural fiber, each of the batches shows variations in shade, which may be visible in products of follow-up orders. Additionally, an inherent feature of all natural fibers is the tendency to delicate fabric pilling.

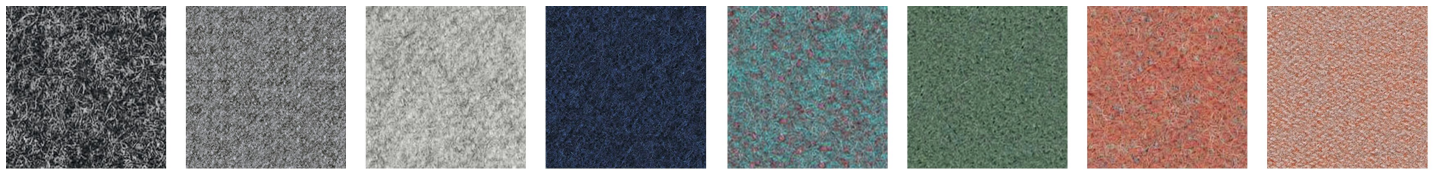

SGY017

SGY016

SGY008

SGY062

SGY056

SGY049

SGY073

SGY074

STEELCUT 3 (KVADRAT) - PRICE GROUP 4

Steelcut 3 is a unicoloured strong worsted wool and polyamide woven fabric, combining durability, soft touch and colour depth. The construction create a three-dimensional surface resembling small pyramids or steel points. Despite its complex weaving technique, it has a simple and precise expression.

Composition: 90% worsted new wool, 10% polyamide

Weight: 825 g/lm

Abrasion resistance: 100 000 Martindale (EN ISO 12947-2)

Flammability: BS EN 1021: 1-2 (Cigarette & match, CA TB 117-2013, BS 5852 Crib 5 (with treatment), BS 5852 part 1, IMO FTP Code 2010 Part 8, NF D 60 013, NFPA 260, UNI 9175 1IM, ÖNORM B1/Q1, AS/NZS 3837 Class 2, ASTM E84 Class A Unadhered, ASTM 84 Class B Adhered

Light fastness: 5 6 (EN ISO 105-B02)

Rubbing fastness: 3-5/4-5 (Wet/Dry) (EN ISO 105X12)

Pilling: 3-4 (EN ISO 12945-2)

Environmental facts: EU Ecolabel, 100% free of heavy metals, ISO 14001 certified company, GREENGUARD Gold

Design: Frans Dijkmeijer, Giulio Ridolfo (updated colourways)

Produced in: United Kingdom

Cleaning: Professional dry cleaning with tetrachloroethylene, normal process (For further info follow Kvadrat´s cleaning guidelines – www.kvadrat.dk)

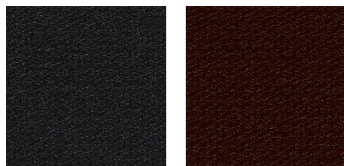

STT190

STT655

STEELCUT TRIO 3 (KVADRAT) - PRICE GROUP 4

Steelcut Trio 3 is a strong worsted wool and polyamide woven fabric, made with three different coloured yarns. The colours and the special weave create a three-dimensional surface where the colours seem to change depending on the angle of perspective. Like Steelcut 3, despite the complexity of the textile's innovative weave, it has a simple, precise expression.

Composition: 90% worsted new wool, 10% polyamide

Weight: 770 g/lm

Abrasion resistance: 100 000 Martindale (EN ISO 12947-2)

Flammability: BS EN 1021: 1-2 (Cigarette & match, CA TB 117-2013, , BS 5852 Crib 5 (with treatment), BS 5852 part 1, BS 5852 ignition source 3, IMO FTP Code 2010 Part 8, NF D 60 013, NFPA 260, UNI 9175 1IM, ÖNORM B1/Q1, AS/NZS 3837 Class 2, GB 50222 B1 with treatment (Chinese)

Light fastness: 6-7 (EN ISO 105-B02)

Rubbing fastness: 3-5/4-5 (Wet/Dry) (EN ISO 105X12)

Pilling: 4 (EN ISO 12945-2)

Environmental facts: EU Ecolabel, 100% free of heavy metals, ISO 14001 certified company, GREENGUARD Gold

Design: Frans Dijkmeijer, Giulio Ridolfo (updated colourways)

Produced in: United Kingdom

Cleaning: Professional dry cleaning with tetrachloroethylene, normal process (For further info follow Kvadrat's cleaning guidelines – www.kvadrat.dk)

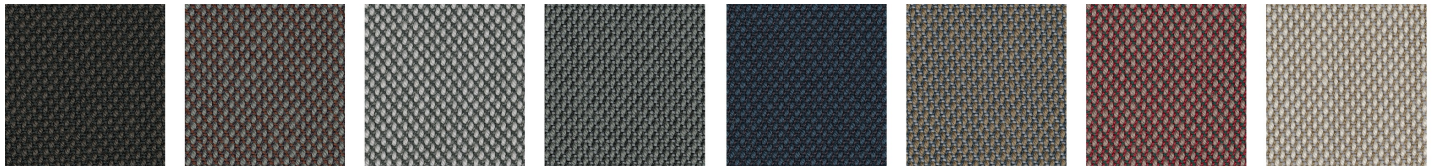

STT383

STT276

STT133

STT153

STT796

STT253

STT645

STT213

PALOMA SOFT (WOLLSDORF) - PRICE GROUP 6

High quality semi-aniline leather. All our standard colours from Paloma have a special finish adding a particular softness to the leather. Excellent friction and breathing properties. The surface may feature small scars and marks resulting from insect bites etc. These are proof of the natural origin of the product and are part of its character.

Flammability: BS EN 1021: 1-2 (Cigarette & match), BS 5852 Crib 5, IMO A.652 (16)

Light fastness: 6 (EN ISO 105-B02)

Rubbing: Wet 80/4 -Dry 2000/4 - Sweat 50/4 - ISO 11640

Finish-adhesion: 2,0 N/cm ISO 11644

Tear-strength: 20 N/mm DIN 53329- A

Environmental facts: Tanned without using chromium salts, BlueAngel, ECO2L-certificate, ISO 14001 certified company

Produced in: Austria

Animal Welfare: All hides are by-products from the meat and dairy industries, only use hides from healthy and uninjured animal. Following European standards as a minimum and the "Five Freedoms" of livestock as defined by FAWC (Farm Animal Welfare Council)

Cleaning: Follow the leather care guide from our supplier – www.wollsdorf.com



ATG56100

ATG55185

ATG55206

ATG55115

ATG55130

Fabrics and finishings

Mesh

Ariz

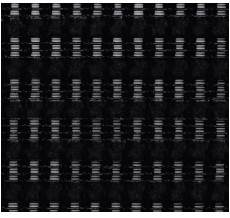

GZ-21

Mesh

Bit



Runner 60061

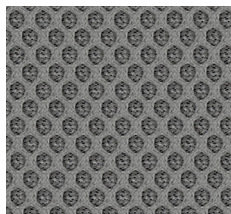

Runner 60011



Runner 60999

Plastics

Ariz



CODE 20



CODE 517

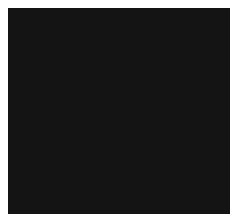

CODE 01



CODE 516



CODE 503



CODE 513



CODE 3020

Finishings colours in print may differ from real ones.

Fabrics and finishings

Plastics

Ellie^{Pro}/ Trillo^{Pro}

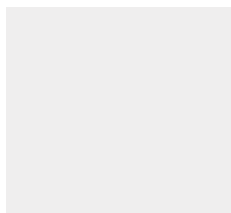

Light grey (RAL 7047)



Black

Plastics

Mickey

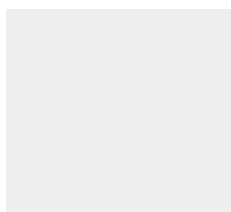

Telegrey 4 (RAL 7047)



Traffic grey B (RAL 7043)

Plastics / frames

Zoo

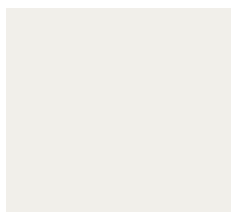

Light grey



Grey



Black (RAL 9005)

Fabrics and finishings

Tempered glass

Chic Tables



G1 (Milky)



G2 (Black)



G3 (RAL 7044)



G4 (RAL 7042)

Kolory stelaży / Frame colours / Gestellfarben

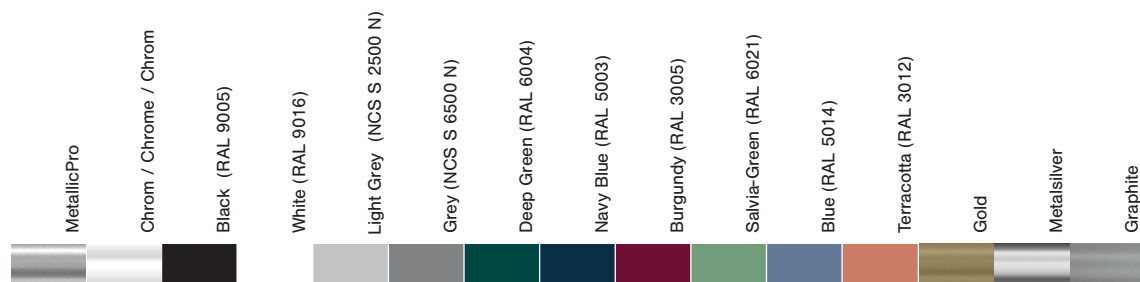

		MetallicPro	Chrom / Chrome / Chrom	Black (RAL 9005)	White (RAL 9016)	Light Grey (NCS S 2500 N)	Grey (NCS S 6500 N)	Deep Green (RAL 6004)	Navy Blue (RAL 5003)	Burgundy (RAL 3005)	Salvia-Green (RAL 6021)	Blue (RAL 5014)	Terracotta (RAL 3012)	Gold	Metalsilver	Graphite
Acos ^{Pro}	V, H, HC	o	o	o	o	o	o	o	o	o	o	o	o			
Arca	V, V PP	o	o	o	o											
Ariz	V, V 2P, CV	o	o	o	o	o	o	o	o	o	o	o	o			
Bit	H, V	o	o	o	o	o	o	o	o	o	o	o	o			
Chic	H	o	o	o	o	o	o	o	o	o	o	o	o	o		
Chic	CH, CR	o	o	o	o	o	o	o	o	o	o	o	o			
Chic Air	H	o	o	o												
Chic Lounge	V3, PV3, F	o	o	o	o	o	o	o	o	o	o	o	o	o		
Chic Tables	RR	o	o	o	o	o	o	o	o	o	o	o	o			
Chic Tables	RH, CS, CR	o	o	o	o	o	o	o	o	o	o	o	o	o		
Com	HC, HF, HS	o	o	o	o	o	o	o	o	o	o	o	o	o		
Com	H, H 2P, V, CV, V1, V1 2P, V2	o	o	o	o	o	o	o	o	o	o	o	o			
Com	L3, L4	o		o												
Ellie ^{Pro} (polished alu)	HST	o	o	o	o	o	o	o	o	o	o	o	o			o
Ellie ^{Pro}	V3	o		o	o	o	o	o	o	o	o	o	o	o	o	
Fan	H, HC, HS, V	o	o	o	o	o	o	o	o	o	o	o	o	o		
Fan	R	o	o	o	o	o	o	o	o	o	o	o	o			
Mickey	-	o		o	o	o	o	o	o	o	o	o	o			
MyTurn Sofa	H, V	o	o	o												
MyTurn Sofa Tables	H, V	o	o	o												
MyTurn	VN		o													
Normo	H, V, HS, HC	o		o	o	o	o	o	o	o	o	o	o			
Nu	H, V3	o	o	o	o	o	o	o	o	o	o	o	o	o		
Nu (polished alu)	HC	o	o	o	o	o	o	o	o	o	o	o	o			o
Nu	R	o	o	o	o	o	o	o	o	o	o	o	o			
October	-	o	o	o												
October Tables	-	o	o	o												
Revo Tables	-	o		o	o	o	o	o	o	o	o	o	o			
Seven	-	o		o	o	o	o	o	o	o	o	o	o			
Snap	-	o		o	o	o	o	o	o	o	o	o	o	o		
SoftBox (polished alu)	-	o	o	o	o	o	o	o	o	o	o	o	o			
SoftBox Tables	-		o	o												
Sorriso	V	o	o	o	o	o	o	o	o	o	o	o	o			
Sun	H, V, H 2P, H 2PB	o	o	o	o	o	o	o	o	o	o	o	o			
Tables	SV, SH, SR	o	o	o	o	o	o	o	o	o	o	o	o			
Trillo ^{Pro} (polished alu)	HST	o	o	o	o											o
Vancouver Lite	H, V	o	o	o	o	o	o	o	o	o	o	o	o			
Wall In	-	o	o	o												
Xenon	H, V, H 2P, V 2P	o	o	o	o	o	o	o	o	o	o	o	o			
Xenon Net	H, V, H 2P, V 2P	o	o	o	o	o	o	o	o	o	o	o	o			
Zoo	H, V, H 2P, V 2P, HC, HC 2P	o	o	o	o	o	o	o	o	o	o	o	o			

	Sklejka bukowa / Stained beech / Holz (Schichtholz Buche)			Okleiny naturalne / Natural veneers / Beiztöne Holz				Okleiny naturalne barwione / Coloured natural veneers / Farben von Edelfurnier				
	H6	H12	H5	Ash (NA)	Beech (NB)	Oak (NO)	Walnut (NW)	White Ash CNA01	Black Ash CNA02	Deep Green Ash CNA05 (RAL 6004)	Navy Blue Ash CNA06 (RAL 5003)	Burgundy Ash CNA07 (RAL 3005)
Chic	<input type="radio"/>	<input type="radio"/>	<input type="radio"/>									
Chic Tables				<input type="radio"/>	<input type="radio"/>	<input type="radio"/>	<input type="radio"/>	<input type="radio"/>	<input type="radio"/>	<input type="radio"/>	<input type="radio"/>	<input type="radio"/>
Com	<input type="radio"/>	<input type="radio"/>	<input type="radio"/>	<input type="radio"/>		<input type="radio"/>	<input type="radio"/>	<input type="radio"/>	<input type="radio"/>	<input type="radio"/>	<input type="radio"/>	<input type="radio"/>
Ellie ^{Pro}	<input type="radio"/>	<input type="radio"/>	<input type="radio"/>									
Fan	<input type="radio"/>	<input type="radio"/>	<input type="radio"/>									
MyTurn Sofa Tables												
Nu	<input type="radio"/>	<input type="radio"/>	<input type="radio"/>									
October	<input type="radio"/>	<input type="radio"/>	<input type="radio"/>									
October Tables	<input type="radio"/>	<input type="radio"/>	<input type="radio"/>									
Revo Tables				<input type="radio"/>	<input type="radio"/>	<input type="radio"/>	<input type="radio"/>	<input type="radio"/>	<input type="radio"/>	<input type="radio"/>	<input type="radio"/>	<input type="radio"/>
SoftBox	<input type="radio"/>	<input type="radio"/>	<input type="radio"/>									
SoftBox Tables												
Tables SH/SR												
Tables SW	<input type="radio"/>	<input type="radio"/>	<input type="radio"/>									
Wall In												

Kolory drewna i sklejkki / Wood colours / Holzfarben

	Okleiny naturalne modyfikowane / Natural modified veneers / Beiztöne Holz								Drewno (dąb) / Wood (Oak) / Holz (Buche)					
	HM10	HM11	HM12	HM20	HPL	White LW01 (RAL 9016)	Light Grey LW03 (NCS S 2500-N)	Grey LW04 (RAL 7037)	Black LW02 (RAL 9011)	Navy Blue LW06 (RAL 5003)	Light Burgundy LW07 (RAL 3004)	HO6	HO12	HO11
Chic														
Chic Tables														
Com						o	o	o	o	o	o			
Ellie ^{Pro}														
Fan												o	o	o
MyTurn Sofa Tables	o	o	o	o		o		o	o					
Nu														
October														
October Tables														
Revo Tables						o	o	o	o	o	o			
SoftBox														
SoftBox Tables	o	o	o	o		o		o	o					
Tables SH/SR						o	o	o	o	o	o			
Tables SW												o	o	o
Wall In						o	o	o	o	o	o			

Kolory kubeków / Shell colours / Schalenfarbe

Legenda / Legend / Legende:

- Standardowy czas realizacji / Standard delivery time / Standardlieferzeit
- Wydłużony czas realizacji / Extended delivery time / Verlängerte Lieferzeit

Model	Plastics														Veneer shell		
	Poppy	Vanilla	Straw	Rose	Coral	Sky	Sea Green	Teal Blue	Forest	Misty Grey	Clay	Graphite	Graphite – recycled PP	Charcoal	Oak	Dark stained Oak	
Ana	●	●					○	●		●		●	●				
Noor 6050/6055	○	●	○	○	○	○	●	●	○	●	●	●			●	○	
Noor 6060/6065	○	●	○	○	○	○	●	●	○	●	●	●			●	○	
Noor 6070/6075	○	●	○	○	○	○	●	●	○	●	●	●			●	○	
Noor 6080/6085	○	●	○	○	○	○	●	●	○	●	●	●			●	○	
Noor Up 6090/6095	○	●	○	○	○	○	●	●	○	●	●	●			●	○	

Kolory stelaży / Frame colours / Gestellfarbe

Legenda / Legend / Legende:

- Standardowy czas realizacji / Standard delivery time / Standardlieferzeit
- Wydłużony czas realizacji / Extended delivery time / Verlängerte Lieferzeit

Model	Frames											Aluminium elements			Wood (Ash)			Aluminium elements for base 6080/6085	
	Lingon RAL 3000	Snow (White) RAL 9016	Canola	Rose	Aqua	Sea Green	Teal Blue	Forest	Misty Grey	Black RAL 9005	Metalsilver	Steelgrey	Polished Alu	White stained Ash	Stained Ash	Dark stained Ash	Black painted Aluminium frame	Polished Aluminium frame	
Ana	○	●				○	●		●	●	●						●		
Noor 6050/6055	○	○		○		●	●	○	○	●	●								
Noor 6060/6065	○	●	○	○	○	●	●	○	○	●	●								
Noor 6070/6075		○							●			○							
Noor 6080/6085														○	●	○	●	○	
Noor Up 6090/6095	○	●	○	○	○	●	●	○	○	●	●						●		

Kolory blatów / Table tops colours / Plattefarbe

Legenda / Legend / Legende:

- Standardowy czas realizacji / Standard delivery time / Standardlieferzeit
- Wydłużony czas realizacji / Extended delivery time / Verlängerte Lieferzeit

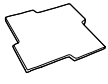

	HPL													Linoleum			
	Polar White Mat Formica F2255	Folkstone Formica F7927	Sarum Grey Formica F2770	Diamond Black Formica F2253	Oak natural Formica F1079	Birch Formica F7921	Pale Ash Nat Formica F1004	Elegant Oak Nat Formica F5374	Refined Walnut Nat Formica F5872	Dark Ash Nat Formica F8575	Kashmir Mat Formica F0187	Oyster Grey Mat Formica F7929	Pumice Mat Formica F7858	Olive Forbo Desktop 4184	Smokey Blue Forbo Desktop 4179	Burgundy Forbo Desktop 4154	Iron Forbo Desktop 4178
Allround	●	●	○	○	○	○	○	○	○	○	○	○	○	○	○	○	○
u-Connect	●	●	○	○	○	○	○	○	○	○	○	○	○	○	○	○	○
Eminent	●	●	○	○	○	○	○	○	○	○	○	○	○	○	○	○	○
Standard Folding table	●	●	○	○	○	○	○	○	○	○	○	○	○				

Kolory stelaży / Frame colours / Gestellfarbe

Legenda / Legend / Legende:

- Standardowy czas realizacji / Standard delivery time / Standardlieferzeit
- Wydłużony czas realizacji / Extended delivery time / Verlängerte Lieferzeit



	Snow RAL 9016	Misty Grey	Metal silver	Steel grey	Black RAL 9005/RAL9011	Polished aluminium
Allround	●		●	●	●	
u-Connect	●	●		●	●	○
Eminent	●		●	●	●	
Standard Folding table		●	●	●		

Rozmiary blatów / Table top sizes / Plattenmaßen

Legenda / Legend / Legende:

- Standardowy czas realizacji / Standard delivery time / Standardlieferzeit
- Wydłużony czas realizacji / Extended delivery time / Verlängerte Lieferzeit
- Standard / Extended

cm	ø60	ø70	ø80	ø100	ø120	ø160	1/2 circle ø160	Ellipse 180 x 100	Trapezium 140x70x70x70, depth 60	80 x 80	90 x 60	120 x 45	120 x 60	120 x 70	120 x 80	120 x 90	140 x 60	140 x 70	140 x 80	160 x 70	160 x 80	180 x 70	180 x 80	180 x 90	
Allround	○	●	○	○	○			○		○				●	●			●	●			○	○	●	○
u-Connect													●	●	●		●	●	●	●	●	●	●	●	●
Eminent					○	○			○	○			●		●		○	●	●		●		●		
Standard Folding table							○				●	●	●	●	●	●	●	●	●	●	●	○	●	○	○

Fabrics - Extended

Lead time 30-40 working days

- Legend: ● Possibility of making the product in the given upholstery
 ○ Possibility of making only the seat in the given upholstery
 □ No possibility of making the walls in the given upholstery
- ◇ Handle always in fabric Next
 - Impossibility of making a product in a given upholstery

	Camira												Gabriel									
	Blazer (PG 3)	Craggan Flax (PG 4)	Era (PG 3)	Gravity (PG 3)	Main Line Flax (PG 3)	Rivet (PG 3)	Quest (PG 3)	Penta (PG 3)	RePlay (PG 3)	Urban (PG 3)	X2 (PG 3)	Breeze Fusion (PG 4)	Chill (PG 3)	Comfort+ (PG 5)	Crisp (PG 3)	Cyber (PG 3)	Fame (PG 3)	Focus (PG 3)	Focus Melange (PG 3)	Focus Royal (PG 3)		
Ana	●	●	●	●	●	●	●	●	●	●	●	●	●	●	●	-	●	●	●	●	●	
Ariz	●	●	●	●	●	●	●	-	●	●	●	●	●	●	●	-	●	●	●	●	-	
Bit	●	-	●	-	●	●	●	-	●	●	●	-	●	●	-	-	●	●	●	●	-	
Chic	●	-	●	-	●	●	●	-	●	●	●	●	●	●	●	-	●	●	●	●	-	
Chic Lounge	●	-	●	-	●	●	●	-	●	●	●	●	●	●	-	-	●	●	●	●	-	
Com	●	-	●	-	●	●	●	-	●	●	●	●	●	●	●	-	●	●	●	●	-	
Ellie ^{Pro}	●	-	●	-	●	●	●	-	●	●	●	●	●	-	●	-	●	●	●	●	-	
Fan	●	-	●	●	●	●	●	-	●	●	●	●	●	●	●	-	●	●	●	●	-	
Mickey	●	-	●	-	●	●	●	-	●	●	●	●	●	●	●	-	●	●	●	●	-	
MyTurn Sofa	●	-	●	-	●	●	●	-	●	●	●	●	●	●	●	-	●	●	●	●	-	
Noor	●	●	●	●	●	●	●	●	●	●	●	●	●	●	●	●	●	●	●	●	●	
Noor F	●	●	-	-	●	-	-	-	-	-	●	-	●	-	-	●	●	●	●	●	●	
Normo	●	-	●	-	●	●	●	-	●	●	●	●	●	●	●	-	●	●	●	●	-	
Nu	●	-	●	-	●	●	●	-	●	●	●	●	●	●	●	-	●	●	●	●	-	
October	●	●	●	-	●	●	●	-	●	●	●	-	●	●	-	-	●	●	●	●	-	
Revo	●	-	●	-	●	●	●	-	●	●	●	●	●	●	-	-	●	●	●	●	-	
Snap 20H	-	-	●	-	●	-	●	-	●	●	●	●	●	-	-	-	●	●	●	●	-	
Snap 21H	-	-	●	-	●	-	●	-	●	●	●	●	●	-	-	-	●	●	●	●	-	
SoftBox	●	-	●	-	●	●	●	-	●	●	●	●	●	●	●	-	●	●	●	●	-	
Sorriso	●	-	●	-	●	●	●	-	●	●	●	-	●	●	●	-	●	●	●	●	-	
Trillo ^{Pro}	●	-	●	-	●	●	●	-	●	●	●	-	●	●	-	-	●	●	●	●	-	
Vancouver Lite	●	-	●	-	●	●	●	-	●	●	●	●	●	●	●	-	●	●	●	●	-	
Vancouver Oto	●	-	●	●	●	●	●	-	●	●	●	●	●	●	●	-	●	●	●	●	-	
Wall In	●	-	●	-	●	●	●	-	●	●	●	●	●	●	●	-	●	●	●	●	-	
Zoo	●	-	●	-	●	●	●	-	●	●	●	-	●	●	-	-	●	●	●	●	-	
Cushions	●	-	●	-	●	●	●	-	●	●	●	-	●	●	-	-	●	●	●	●	-	

Fabrics - Extended

Lead time 30-40 working days

Future Loop (PG 3)	Gaja Classic (PG 3)	Go_Check (PG 3)	Go_Couture (PG 3)	Go_Uni (PG 3)	Just (PG 3)	Mica (PG 3)	Nobel (PG 3)	Passion (PG 4)	Parcel Loop (PG 3)	Renewed Loop (PG 3)	Step Melange (PG 3)	Tailor (PG 3)	TwinWool (PG 3)	Umber (PG 3)	GU	Amdal (PG 4)	Bardal (PG 4)	Heidal (PG 4)	Sirdal (PG 4)	Suldal (PG 4)	
●	●	●	-	-	-	-	●	●	●	●	●	●	●	●	●	●	●	●	●	●	Ana
-	●	●	●	●	●	●	-	-	-	●	●	-	-	-	●	●	●	●	●	●	Ariz
-	-	●	●	●	●	●	-	-	-	●	●	-	-	-	-	-	-	-	-	-	Bit
-	-	●	●	●	●	●	-	-	-	●	●	-	-	-	●	●	●	●	●	●	Chic
-	-	●	●	●	●	●	-	-	-	●	●	-	-	-	●	●	●	●	●	●	Chic Lounge
-	-	●	●	●	●	●	-	-	-	●	●	-	-	-	●	●	●	●	●	●	Com
-	-	●	●	●	●	●	-	-	-	●	●	-	-	-	●	●	●	●	●	●	Ellie ^{P_{no}}
-	●	●	●	●	●	●	-	-	-	●	●	-	-	-	●	●	●	●	●	●	Fan
-	-	●	●	●	●	●	-	-	-	●	●	-	-	-	●	●	●	●	●	●	Mickey
-	-	●	●	●	●	●	-	-	-	●	●	-	-	-	●	●	●	●	●	●	MyTurn Sofa
●	●	●	-	-	-	-	●	●	●	●	●	●	●	●	●	●	●	●	●	●	Noor
●	●	●	-	-	-	-	●	-	●	●	●	●	●	●	●	●	-	●	●	●	Noor F
-	-	●	●	●	●	●	-	-	-	●	●	-	-	-	●	●	●	●	●	●	Normo
-	●	●	●	●	●	●	-	-	-	●	●	-	-	-	●	●	●	●	●	●	Nu
-	-	●	●	●	●	●	-	-	-	●	●	-	-	-	-	-	-	-	-	-	October
-	-	●	●	●	●	●	-	-	-	●	●	-	-	-	-	-	-	-	-	-	Revo
-	-	●	●	●	●	●	-	-	-	●	●	-	-	-	-	-	-	-	-	-	Snap 20H
-	-	●	●	●	●	●	-	-	-	●	●	-	-	-	-	-	-	-	-	-	Snap 21H
-	-	●	●	●	●	●	-	-	-	●	●	-	-	-	●	●	●	●	●	●	SoftBox
-	●	●	●	●	●	●	-	-	-	●	●	-	-	-	-	-	-	-	-	-	Sorriso
-	-	●	●	●	●	●	-	-	-	●	●	-	-	-	-	-	-	-	-	-	Trillo ^{P_{no}}
-	-	●	●	●	●	●	-	-	-	●	●	-	-	-	●	●	●	●	●	●	Vancouver Lite
-	●	●	●	●	●	●	-	-	-	●	●	-	-	-	●	●	●	●	●	●	Vancouver Oto
-	-	●	●	●	●	●	-	-	-	●	●	-	-	-	●	●	●	●	●	●	Wall In
-	-	●	●	●	●	●	-	-	-	●	●	-	-	-	-	-	-	-	-	-	Zoo
-	-	●	●	●	●	●	-	-	-	●	●	-	-	-	-	-	-	-	-	-	Cushions

Fabrics - Extended

Lead time 30-40 working days

- Legend: ● Possibility of making the product in the given upholstery
 ○ Possibility of making only the seat in the given upholstery
 □ No possibility of making the walls in the given upholstery
- ◇ Handle always in fabric Next
 - Impossibility of making a product in a given upholstery



























	Kvadrat	Atlas (PG 3)	Canvas (PG 4)	Coda (PG 6)	Divina Melange (PG 5)	Divina (PG 5)	Divina MD(PG 5)	Fjord 2 (PG 4)	Hallingdal 65 (PG 5)	Melange Nap (PG 4)	Navell (PG 4)	Remix (PG 3)	Re-wool (PG 3)	Serpentine(PG 6)	Steelcut Quartet (PG 4)	Twill Weave (PG 5)	Tonus 4 (PG 5)	Vidal 4 (PG 4)	Neotex	Illusion (PG 4)	Illusion Full Grain(PG 4)
Ana	●	●	●	●	●	●	●	●	●	●	-	●	●	●	-	●	●	-	●	●	
Ariz	●	●	-	●	●	●	-	●	●	●	●	●	●	-	●	●	●	●	○	-	
Bit	●	●	-	●	●	-	-	-	●	●	●	●	●	-	●	●	-	●	-	-	
Chic	●	●	●	●	●	●	-	●	●	●	●	●	●	-	●	●	●	●	-	-	
Chic Lounge	●	●	●	-	●	●	-	●	●	-	●	●	●	-	-	●	●	-	-	-	
Com	●	●	-	●	●	●	-	●	●	●	●	●	●	-	●	●	●	●	-	-	
Ellie ^{Pro}	●	●	-	●	●	●	-	●	●	-	●	●	●	-	-	●	●	-	-	-	
Fan	●	●	●	●	●	●	-	●	●	●	●	●	●	-	●	●	●	●	-	-	
Mickey	●	●	◇	◇	◇	●	-	●	●	●	●	●	●	-	●	●	●	●	-	-	
MyTurn Sofa	●	●	●	●	●	●	-	●	●	●	●	●	●	-	●	●	●	●	-	-	
Noor	●	●	●	●	●	●	●	●	●	●	●	●	●	●	●	●	●	●	●	●	
Noor F	-	-	●	●	●	●	●	●	●	-	●	●	●	●	-	●	-	-	-	-	
Normo	●	●	●	●	●	●	-	●	●	-	●	●	●	-	-	●	●	-	-	-	
Nu	●	●	●	●	●	●	-	●	●	●	●	●	●	-	●	●	●	●	-	-	
October	●	●	●	●	●	-	-	-	●	●	●	●	●	-	●	●	-	●	-	-	
Revo	●	●	●	●	●	-	-	-	●	●	●	●	●	-	●	●	-	●	-	-	
Snap 20H	●	●	●	●	●	●	-	●	●	●	●	●	●	-	●	-	-	●	-	-	
Snap 21H	-	●	●	●	●	●	-	●	●	●	●	●	●	-	●	-	-	●	-	-	
SoftBox	●	●	●	●	●	●	-	●	●	-	●	●	●	-	-	●	●	-	-	-	
Sorriso	●	●	●	●	●	-	-	-	●	●	●	●	●	-	●	●	●	●	-	-	
Trillo ^{Pro}	●	●	-	●	●	-	-	-	●	●	●	●	●	-	●	●	-	●	-	-	
Vancouver Lite	●	●	●	●	●	●	-	●	●	●	●	●	●	-	●	●	●	●	-	-	
Vancouver Oto	●	●	●	●	●	●	-	●	●	●	●	●	●	-	●	●	●	●	-	-	
Wall In	●	●	●	●	●	●	-	●	●	●	●	●	●	-	●	●	●	●	-	-	
Zoo	●	●	-	●	●	-	-	-	●	●	●	●	●	-	●	●	-	●	-	-	
Cushions	●	●	●	●	●	-	-	-	●	-	●	●	●	-	-	●	-	-	-	-	

Fabrics - Extended

Lead time 30-40 working days

	Oniro		Sanwil	Sofline (PG 3)	Spradling			Svensson	Khaki (PG 3)	Marco(PG 6)	Node (PG 3)	Poppy (PG 4)	Semi (PG 3)	Step (PG 3)	Textafoam		
	PJxx 1 (PG 3)	PJxx 2 (PG 3)			Silvertex (PG 3)	Valencia (PG 1)	Valencia Biosense (PG 6)								Velvet (PG 3)		
	●	●	●	●	●	●	●	●	●	●	●	●	●	●	-	-	Ana
	○	○	●	●	●	●	-	●	-	-	-	●	●	●	-	-	Ariz
	-	-	●	●	●	●	-	-	-	-	-	●	●	-	-	-	Bit
	-	-	●	●	●	●	-	-	-	-	-	●	●	-	-	●	Chic
	-	-	-	-	-	-	-	-	-	-	-	●	●	-	-	●	Chic Lounge
	○	○	●	●	●	●	-	-	-	-	-	●	●	-	-	-	Com
	-	-	-	-	-	-	-	-	-	-	-	●	●	-	-	●	Ellie ^{Pro}
	-	-	●	●	●	●	-	-	-	-	-	●	●	-	-	●	Fan
	-	-	-	-	◇	●	-	-	-	-	-	●	●	-	-	●	Mickey
	-	-	●	●	●	●	-	-	-	-	-	●	-	-	-	-	MyTurn Sofa
	●	●	●	●	●	●	-	●	●	●	-	-	●	●	-	-	Noor
	-	-	-	-	-	-	●	-	●	●	-	-	●	●	-	-	Noor F
	-	-	-	-	-	-	-	-	-	-	-	●	●	-	-	●	Normo
	-	-	-	-	●	●	-	-	-	-	-	●	●	-	-	●	Nu
	-	-	●	●	●	●	-	-	-	-	-	●	●	-	-	●	October
	-	-	●	●	●	●	-	-	-	-	-	●	●	-	-	-	Revo
	-	-	●	●	●	-	-	-	-	-	-	●	●	-	-	-	Snap 20H
	-	-	-	-	-	-	-	-	-	-	-	●	●	-	-	-	Snap 21H
	-	-	●	●	▣	▣	-	-	-	-	-	●	●	-	-	-	SoftBox
	-	-	●	●	●	●	-	-	-	-	-	●	●	-	-	-	Sorriso
	-	-	●	●	●	●	-	-	-	-	-	●	●	-	-	-	Trillo ^{Pro}
	-	-	●	●	●	●	-	-	-	-	-	●	●	-	-	●	Vancouver Lite
	-	-	●	●	●	●	-	-	-	-	-	●	●	-	-	●	Vancouver Oto
	-	-	●	●	▣	▣	-	-	-	-	-	●	●	-	-	-	Wall In
	-	-	-	-	●	●	-	-	-	-	-	●	●	-	-	-	Zoo
	-	-	-	-	●	●	-	-	-	-	-	●	●	-	-	●	Cushions

Legend

 20,0	net weight		Ergonomie geprüft
 22,5	gross weight		GS (geprüfte Sicherheit)
 10	stacking (max. quantity)		Quality Office
 15	stacking on trolley for transportation (max. quantity)		MöBELFAKTA
	right-sided table top		The Blue Angel
	left-sided table top	www.blauer-engel.de/uz117	
	joining in rows		Forest Stewardship Council®
	two-colour upholstery		Environmental Product Declarations (EPD)
	teflon glides		GS (Intertek)
	felt glides		EU Ecolabel: PL/049/001
	special threads		
	clothes hanger		
	Mediaport		
	guarantee period		
	ISO 9001		
	ISO 14001		
	Chrom (III)		
	The mark of responsible forestry. Concerns only products indicated as FSC® certified.		

Social Media

Facebook

YouTube

Instagram

Pinterest

LinkedIn

Office

Flokk A/S

Sorgenfrivej 18

2800 Kongens Lyngby