

# Price List

Valid from the 10th of September 2024  
edition 1

All prices: DKK

# Contents

Order entry specifications	4
Armchairs, swivel chairs and pouffes	5
Profim MICKEY	7
Profim TRILLO PRO	8
Visitor chairs	9
Profim ANA	11
Profim ARIZ	13
Profim BIT	16
Profim COM	19
Profim NOOR 4-LEG	26
Profim NOOR SLEDGEBASE	28
Profim NOOR FOOTBASE	30
Profim NOOR WOODEN LEGS	32
Profim NOOR UP	34
Profim NORMO	36
Profim ZOO	38
Sofas, armchairs, modular systems	41
Profim CHIC	43
Profim CHIC LOUNGE	45
Profim ELLIE PRO	47
Profim FAN	49
Profim MYTURN SOFA	52
Profim MYTURN TABLE	54
Profim NU	55
Profim OCTOBER	58
Profim OCTOBER TABLE	60
Profim REVO	61
Profim SNAP	64
Profim SOFTBOX	67
Profim SORRISO	73
Profim VANCOUVER LITE	74
Profim VANCOUVER OTO	78
Profim WALL IN	80
Tables, coat stands and accessories	85
Profim ALLROUND	87
Profim CHIC COFFEE TABLE	91
Profim CHIC RESTAURANT TABLE	93



Profim EMINENT	96
Profim Eminent - suspension bracket system	99
Profim REVO TABLES	100
Profim STANDARD FOLDING TABLE	104
Profim TABLES	108
Profim U-CONNECT	110
Profim SEVEN	113
Profim CUSHION	114
Technical details	115
Technical details	120
Fabrics and finishings	179
Profim Standard fabrics	180
Fabrics and finishings - Extended	195
Legend	199

# ORDER ENTRY SPECIFICATIONS

When placing your order please remember to specify the following information:

- Product model code/name
- Number of products
- Fabric/leather and Colour Code
- Wooden, stain surface, plastic and table top colour/type
- Colour/paint on foot base/frame for chairs and tables
- Type of castors or glides
- Options. Eg. armrests, linking device
- Desired delivery date
- Delivery address

Binding sales agreement for the ordered products is concluded by formal order confirmation sent by Flokk.

Flokk sales conditions override any individual customer's general terms & conditions or regulations.

## PRICES

All prices in DKK exclusive of VAT. Valid from 01/01/2024 Any typographical errors shall not be binding for Flokk and will be subject to correction without liability to the vendor.

## CONDITIONS OF DELIVERY

Ex Works (Incoterms 2020), including packaging. A 3% transportation & energy cost surcharge on the net order value will be applied to all orders with delivery terms agreed different from Ex works.

Shipping fee of 5% of the net order value (min. DKK 250) is added on all orders, which is not delivered to addresses used or owned by the distributor.

Visible transport damage and discrepancies in the number of items received must always be noted on the bill of carriage at the time of receipt and reported to the carrier and Customer Service, Flokk A/S within 7 calendar days after receipt of the goods. Invisible damage (means no damaged packaging) must be reported in writing to Customer Service, Flokk A/S within 7 calendar days after receipt. If there are any problems with registration of the claim, please write to Customer Service Flokk immediate when the problems occur. Documentation must follow the e-mail.

For transport damage you need to take photos and document the damage, before reporting in writing to Customer Service, Flokk. Please document:

- Picture of Flokk product label (including order no.)
- Pictures of damaged goods
- Pictures of damaged packaging
- Copy of transport document (if provided)
- Short description of claim

We encourage you to ensure recycling of all packaging material. Please sort and return the packaging material, using your local recycling partners/stations and follow your local regulations.

## CHANGE/CANCELLATION OF ORDERS

Change/cancellation of orders on chairs or upholstery are possible up until production has begun.

Changes made 2 days after receiving the order confirmation, each amended or cancelled order will incur a charge per order (see below). Once production has started orders cannot be changed.

Each amended or cancelled order will incur a charge:

- Amended order (all changes & cancellations) before production start will incur a charge of 500 DKK per order
- Amended order & cancellations after purchasing has started will incur a charge of 750 DKK per order + cost of materials

For further information regarding change/cancellation of orders, please feel free to contact Customer Service, Flokk A/S.

## NON-STANDARD PRODUCTS

Non-standard products not available in this pricelist could be proceed with quantities starting from 5 pcs and will be priced individually.

Fabrics and leathers that are not tested on our products, need to have an upholstery test before we can approve it and the order can be registered. Cost (DKK 1.545) for testing will be charged. Please contact Customer Service, Flokk A/S.

	Standard production time*	Non standard production time*
<b>Product</b>	standard: 10-20 working days	extended: 30 working days
<b>Task chairs</b>	10-20 working days	-
<b>Visitor chairs</b>	10-20 working days	exceptions: Com (plywood shells), Acos <sup>Pro</sup> ; MyTurn, Normo - 20-30 working days. Extended colours for Noor and Ana: 20-30 working days.
<b>Soft seating</b>	10-20 working days	-
<b>Tables &amp; Coat hangers</b>	20-30 working days	-
<b>special colors of frames</b>	40 working days	-

\* Transport days to be added.

Longer delivery times may occur periodically, during holidays and for especially large orders.

Armchairs

Swivel chairs

Pouffes



# Profim MICKEY

## ITO Design

- It is a unique combination of a pouffe and a swivel stool with height adjustment
- Totally intuitive and easy to use
- Provides support by tilting from side to side (range of 10 degrees in each direction)
- Three colours of plastic parts
- Möbelfakta certificate - a guarantee of durability, safety, environmental care and social responsibility during the production process

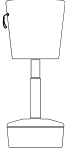
Item no	Base model +	Price Group (PG)	Price Group						Price
			0	①	②	③	④	⑤	
MMC0000000	Profim MICKEY <ul style="list-style-type: none"> <li>• stool, swivel with height adjustment and sideways tilt 10°</li> <li>• base: lightgrey (RAL 7047) / grey (RAL 7043) / beige (RAL 7036)</li> </ul>		2 708	2 821	3 105	3 246	3 387	3 950	4 312

**0 price group: Evo**

**1 price group: Cura, Tonal, Xtreme**

**2 price group: Select**

**3 price group: Capture, Oceanic, Step, Synergy**

**4 price group: Steelcut 3, Steelcut Trio 3**

Base: lightgrey (RAL 7047) / grey (RAL 7043) / beige (RAL 7036) - when ordering please clearly indicate the chosen option.

Glides:

- teflon glides - universal (set).

When ordering please clearly indicate the chosen option.

The sides of the base can be made of:

- the same fabric as the seat,

- plastic in the same colour as the rest of plastic elements.

Please clearly indicate on your order the chosen option.

Handle for height adjustment is always made of the same fabric as the rest of the seat.



Plastic elements and the cover of the gas lift are made of different materials therefore their colour might vary slightly.



# Profim TRILLO PRO

## ITO Design

- Easily adjustable basic functions.
- Synchro self mechanism ensures adjustment to user's weight
- Several versions to choose from: backrest in plastic or with upholstered pad, plastics in two colours,
- Blue Angel certificate - confirms that our chair is environmentally friendly

Item no	Base model +	Price Group (PG)	0	①	②	③	④	⑤	Price
MSX200HS00	Profim TRILLO PRO 20HST <ul style="list-style-type: none"> <li>• plastic backrest</li> <li>• self mechanism</li> <li>• 4-star base, high</li> <li>• base: black / white / graphite / polished aluminum / MetallicPro</li> </ul>		2 491	2 660	2 754	2 754	3 024	3 195	
MSX210HS00	Profim TRILLO PRO 21HST <ul style="list-style-type: none"> <li>• plastic backrest with upholstered pad</li> <li>• self mechanism</li> <li>• 4-star base, high</li> <li>• base: black / white / graphite / polished aluminum / MetallicPro</li> </ul>		2 823	3 079	3 241	3 241	3 767	3 761	

**0 price group: Evo**

**1 price group: Cura, Tonal, Xtreme**

**2 price group: Select**

**3 price group: Capture, Oceanic, Step, Synergy**

**4 price group: Steelcut 3, Steelcut Trio 3**

Castors/glides:

- hard castors - for soft floors (set),
- soft castors - for hard floors (set),

Plastic colours:- black, grey (RAL 7043), light grey (RAL 7047).

Plastic elements: backrest and armrests.

In models 20HST / 21HST:

- base colour black / MetallicPro - plastic elements black, castors black,
- base colour white - plastic elements lightgrey (RAL 7047), castors lightgrey,
- base colour graphite - plastic elements black or grey (RAL 7043), castors black,
- base colour polished aluminium - plastic elements black, grey (RAL 7043) and castors black or plastic elements light grey (RAL 7047) and castors lightgrey.

Please clearly indicate on your order the chosen option.



[www.blauer-engel.de/uz117](http://www.blauer-engel.de/uz117)

Visitor chairs







# Profim ANA

Tias Eckhoff

- Polypropylene (PP) shell in various colours.

Item no	Base model +	Price Group (PG)	Price Group						Price	
			0	①	②	③	④	⑤		⑥
4340	Profim ANA 4340 • Without upholstery									675
4340s	Profim ANA 4340s • Upholstered seat		1067	1096	1124	1223	1289	1402	1795	
4340sr	Profim ANA 4340sr • Upholstered seat and back		1388	1434	1462	1594	1681	1829	2342	

## Accessories/Options/Surcharges:

3YES	Linking device, welded. Must be specified at time of order. Can not be retrofitted.	102
PD303	Felt glides - 4 units.	61
149285	Chair trolley	2909
M400-1/2/3/4	Writing tablet in 12 mm beech or birch veneer, frame - only Metalsilver. Right/left	980
RS091016	Plastic link, black, detachable	37

**0 price group: Evo**

**1 price group: Cura, Tonal, Xtreme**

**2 price group: Select**

**3 price group: Capture, Oceanic, Step, Synergy**

**4 price group: Steelcut 3, Steelcut Trio 3**

Frame of 19 x 1.5 mm tubular steel available in various colours.

Weight 3.7 kg model 4340.

Height: Seat 430 mm, Back 400 mm, Chair width 490 mm, Chair height 825 mm, Chair depth 515 mm.

Stackable up to 12 chairs without upholstery (height: 1.83 m), 10 chairs with seat upholstery (height: 1.65 m) and 7 chairs with seat and back upholstery.

Can be linked together using linking device - see options.

Table suspension Profim Ana. See Profim Eminent table.

Graphite shell colour in recycled PP.

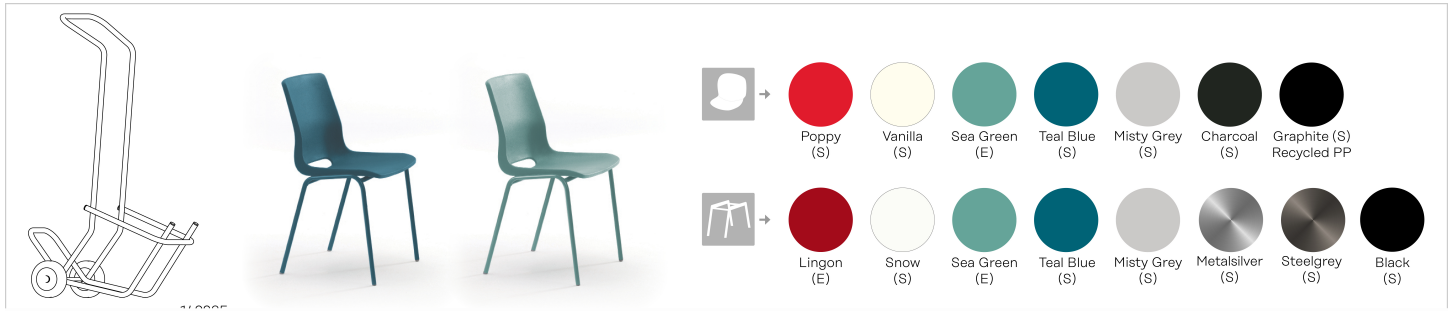

S=Standard Collection – normal delivery time from factory 10-15 working days. Applicable when all component options (fabric, shell, frame/legs) are standard(S).







E=Extended Collection – normal delivery time from factory 20-30 working days. Applicable when any or all component options selected are extended (E).





For larger orders, please contact Customer Service for delivery details.



# Profim ARIZ

- Wide configuration possibilities with several plastic colours and a wide range of upholstery fabrics
- Plastic, upholstered, and mesh versions.
- Version with comfortable armrest available
- Possibility of high stacking (up to 45 pieces on a special trolley for chair transport)
- Option to join in rows, mount writing top and newspaper basket
- Möbelfakta certificate - a guarantee of durability, safety, environmental care and social responsibility during the production process

Item no	Base model +	Price Group (PG)	0	①	②	③	④	⑤	Price
MWE500V000	Profim ARIZ 550V • plastic seat and backrest • frame: black								1168
MWE550V000	Profim ARIZ 555V • plastic seat • mesh backrest • frame: black								1400
MWE600V000	Profim ARIZ 560V • upholstered seat • plastic backrest • frame: black		1323	1408	1485	1485	1679	1723	
MWE700V000	Profim ARIZ 570V • upholstered seat and backrest • frame: black		1571	1732	1981	1981	2576	2298	
MWE750V000	Profim ARIZ 575V • upholstered seat • mesh backrest • frame: black		1578	1679	1741	1741	1950	2019	
MWE500CV00	Profim ARIZ 550CV • bar stool • plastic seat and backrest • frame: black								1624

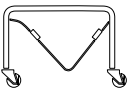
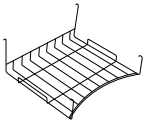
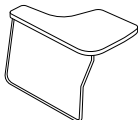
Item no	Base model +	Price Group (PG)	0	①	②	③	④	⑤	Price
MWE550CV00	Profim ARIZ 555CV • bar stool • plastic seat • mesh backrest • frame: black								1794
MWE600CV00	Profim ARIZ 560CV • bar stool • upholstered seat • plastic backrest • frame: black		1756	1864	1950	1950	2142	2262	
MWE700CV00	Profim ARIZ 570CV • bar stool • upholstered seat and backrest • frame: black		2003	2189	2437	2437	3032	2827	
MWE750CV00	Profim ARIZ 575CV • bar stool • upholstered seat • mesh backrest • frame: black		2012	2135	2197	2197	2406	2548	
MWE000W000	Profim ARIZ Chairs' trolley (W)								2413
MPDWEKO000	Profim ARIZ Newspapers bin (K)								294
MPDWEBL000	Profim ARIZ Table top (B)								913

### Accessories/Options/Surcharges:

7COPR002	Frames colours: MetallicPro, White RAL 9016, Deep Green RAL 6004, Navy Blue RAL 5003, Burgundy RAL 3005, Salvia/Green RAL 6021, Blue RAL 5014, Terracota RAL 3012 (Only for: 550CV, 550V, 555CV, 555V, 560CV, 560V, 570CV, 570V, 575CV, 575V)	24
7COPR003	Frames colours: Lightgrey NCS S 2500-N; Grey NCS S 6500-N (Only for: 550CV, 550V, 555CV, 555V, 560CV, 560V, 570CV, 570V, 575CV, 575V)	85
7ARMR001	Armrests - metal, polypropylene pad (set) (Only for: 550V, 555V, 560V, 570V, 575V)	518

**0 price group: Evo**

**1 price group: Cura, Tonal, Xtreme**

**2 price group: Select**

**3 price group: Capture, Oceanic, Step, Synergy**

**4 price group: Steelcut 3, Steelcut Trio 3**

Glides:

- standard - teflon glides (universal).
- option - felt glides (for hard floors).

When ordering please clearly indicate the chosen option.

Colours of plastics:

black (CODE 01), white (CODE 20), gray blue (CODE 503), olive green (CODE 513), red (CODE 3020), navy (CODE 516), ashen (CODE 517).

In models Ariz 555/575 backrest frame only in colours: black, white and ashen.

Available versions with mesh backrest (in Ariz 555 model):

- black plastic seat (CODE 01) + black backrest frame (CODE 01) + black mesh,
- white plastic seat (CODE 20) + white backrest frame (CODE 20) + black mesh,
- ashen plastic seat (CODE 517) + ashen backrest frame (CODE 517) + black mesh.

In standard there is no option of different colours of backrest and seat.

Type of mesh: GZ.

Accessories only for 550V / 555V / 560V / 570V / 575V models:



- Chairs' trolley - frame colour is always black.
- Table top (B) - assembled on the left or right hand, available in chairs without armrests only, table top's frame colour is always chrome.
- Newspapers bin (K) - mounted under the seat, colour is always chrome.



# Profim BIT

- Cantilever- or leg-mounted version
- Stackable
- Option to join in rows
- Choice of plastic or upholstered seat and plastic, mesh or upholstered backrest

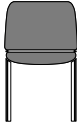
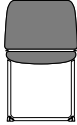
Item no	Base model +	Price Group (PG)	0	①	②	③	④	⑤	Price
MBT500H000	Profim BIT 550H • 4-legged • plastic seat and backrest • frame: black								1168
MBT500V000	Profim BIT 550V • cantilever • plastic seat and backrest • frame: black								1485
MBT550H000	Profim BIT 555H • 4-legged • plastic seat • mesh backrest • frame: black								1439
MBT550V000	Profim BIT 555V • cantilever • plastic seat • mesh backrest • frame: black								1710
MBT600H000	Profim BIT 560H • 4-legged • seat upholstered pad • plastic backrest • frame: black		1415	1617	1787	1787	1996	2073	
MBT600V000	Profim BIT 560V • cantilever • seat upholstered pad • plastic backrest • frame: black		1725	1895	2104	2104	2297	2441	

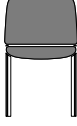
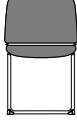
Item no	Base model +	Price Group (PG)	0	①	②	③	④	⑤	Price
MBT700H000	Profim BIT 570H • 4-legged • seat and backrest • upholstered pads • frame: black		1 602	1 849	2 243	2 243	2 645	2 602	
MBT700V000	Profim BIT 570V • cantilever • seat and backrest • upholstered pads • frame: black		1 887	2 166	2 537	2 537	2 947	2 943	
MBT750H000	Profim BIT 575H • 4-legged • seat upholstered pad • mesh backrest • frame: black		1 671	1 849	2 034	2 116	2 251	2 360	
MBT750V000	Profim BIT 575V • cantilever • seat upholstered pad • mesh backrest • frame: black		1 972	2 158	2 336	2 430	2 537	2 710	
MBT800H000	Profim BIT 580H • 4-legged • seat and backrest fully upholstered • frame: black		1 602	2 220	3 055	3 178	3 597	3 544	
MBT800V000	Profim BIT 580V • cantilever • seat and backrest fully upholstered • frame: black		1 887	2 521	3 357	3 491	3 899	3 893	
<b>Accessories/Options/Surcharges:</b>									
7ARMR001	Armrests - plastic, always black (set)								240
7SEQU001	Quilting - pad or front side of the seat (Q1) (Only for: MBT600H000, 560V, 570H, 570V, 575H, 575V)								317
7BAQU001	Quilting - pad or front of the backrest (Q2) (Only for: 570H, 570V)								263

0 price group: Evo

1 price group: Cura, Tonal, Xtreme

2 price group: Select

**3 price group: Capture, Oceanic, Step, Synergy**

**4 price group: Steelcut 3, Steelcut Trio 3**

Glides:

- standard - teflon glides (universal),
- option - felt glides (for hard floors).

When ordering please clearly indicate the chosen option.

Plastic of backrest and seat - always black.

Backrest mesh - always black.

Types of mesh: Runner.

Quilting - extra charge to all price groups, lead time 30-40 working days.













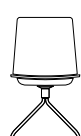





# Profim COM

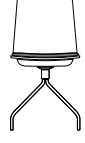
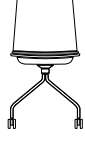
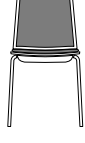



## Paul Brooks

- Five types of bases allow any configuration
- The collection is completed with a barstool on a metal wire frame
- The square shape of the shell has four finishing options: plywood, with upholstered seat pad, with seat and backrest pad or fully upholstered
- The shell can come in different finishes: lacquered plywood, lined with natural veneer or HPL laminate which is scratch resistant

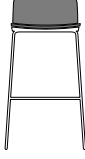
Item no	Base model +	Price Group (PG)	Price Group						Price
			0	①	②	③	④	⑤	
MCM120H000	Profim COM K12H <ul style="list-style-type: none"> <li>• 4-legged</li> <li>• frame: black</li> <li>• plywood shell</li> </ul>								1050
MCM120V000	Profim COM K12V <ul style="list-style-type: none"> <li>• cantilever</li> <li>• wire frame</li> <li>• frame: black</li> <li>• stackable</li> <li>• plywood shell</li> </ul>								1132
MCM120CV00	Profim COM K12CV <ul style="list-style-type: none"> <li>• barstool</li> <li>• frame: black</li> <li>• plywood shell</li> </ul>								1581
MCM120HF00	Profim COM K12HF <ul style="list-style-type: none"> <li>• "spider" frame</li> <li>• frame: black</li> <li>• plywood shell</li> </ul>								2135
MCM120HS00	Profim COM K12HS <ul style="list-style-type: none"> <li>• "spider" frame</li> <li>• frame: black</li> <li>• swivel</li> <li>• plywood shell</li> </ul>								2377
MCM120HC00	Profim COM K12HC <ul style="list-style-type: none"> <li>• "spider" frame</li> <li>• frame: black</li> <li>• on castors</li> <li>• plywood shell</li> </ul>								2415

Item no	Base model +	Price Group (PG)	Price Group						Price
			0	①	②	③	④	⑤	
MCM220H000	Profim COM K22H <ul style="list-style-type: none"> <li>• 4-legged</li> <li>• frame: black</li> <li>• plywood shell</li> <li>• seat upholstered pad</li> </ul>		1323	1377	1515	1583	1652	1928	2064
MCM220V000	Profim COM K22V <ul style="list-style-type: none"> <li>• cantilever</li> <li>• wire fame</li> <li>• frame: black</li> <li>• stackable</li> <li>• plywood shell</li> <li>• seat upholstered pad</li> </ul>		1400	1458	1606	1678	1750	2044	2188
MCM220CV00	Profim COM K22CV <ul style="list-style-type: none"> <li>• barstool</li> <li>• frame: black</li> <li>• plywood shell</li> <li>• seat upholstered pad</li> </ul>		1833	1910	2099	2196	2291	2673	2863
MCM220HF00	Profim COM K22HF <ul style="list-style-type: none"> <li>• "spider" frame</li> <li>• frame: black</li> <li>• plywood shell</li> <li>• seat upholstered pad</li> </ul>		2379	2478	2726	2850	2976	3470	3717
MCM220HS00	Profim COM K22HS <ul style="list-style-type: none"> <li>• "spider" frame</li> <li>• frame: black</li> <li>• swivel</li> <li>• seat upholstered pad</li> </ul>		2612	2721	2967	3092	3216	3712	3960
MCM220HC00	Profim COM K22HC <ul style="list-style-type: none"> <li>• "spider" frame</li> <li>• frame: black</li> <li>• on castors</li> <li>• seat upholstered pad</li> </ul>		2648	2758	3006	3130	3255	3749	3997
MCM320H000	Profim COM K32H <ul style="list-style-type: none"> <li>• 4-legged</li> <li>• frame: black</li> <li>• plywood shell</li> <li>• seat and backrest upholstered pads</li> </ul>		1661	1730	1906	1991	2079	2426	2598

Item no	Base model +	Price Group (PG)	Price Group						Price
			0	①	②	③	④	⑤	
MCM320V000	Profim COM K32V <ul style="list-style-type: none"> <li>• cantilever</li> <li>• wire frame</li> <li>• frame: black</li> <li>• stackable</li> <li>• plywood shell</li> <li>• seat and backrest upholstered pads</li> </ul>		1742	1814	1994	2085	2176	2539	2718
MCM320HF00	Profim COM K32HF <ul style="list-style-type: none"> <li>• "spider" frame</li> <li>• frame: black</li> <li>• plywood shell</li> <li>• seat and backrest upholstered pads</li> </ul>		2721	2835	3118	3260	3402	3969	4252
MCM320HS00	Profim COM K32HS <ul style="list-style-type: none"> <li>• "spider" frame</li> <li>• frame: black</li> <li>• swivel</li> <li>• seat and backrest upholstered pads</li> </ul>		2954	3077	3360	3501	3643	4210	4494
MCM320HC00	Profim COM K32HC <ul style="list-style-type: none"> <li>• "spider" frame</li> <li>• frame: black</li> <li>• on castors</li> <li>• seat and backrest upholstered pads</li> </ul>		2989	3114	3397	3540	3681	4248	4531
MCM420H000	Profim COM K42H <ul style="list-style-type: none"> <li>• 4-legged</li> <li>• frame: black</li> <li>• fully upholstered</li> </ul>		1491	1553	1710	1787	1866	2176	2331
MCM420V000	Profim COM K42V <ul style="list-style-type: none"> <li>• cantilever</li> <li>• wire frame</li> <li>• frame: black</li> <li>• stackable</li> <li>• fully upholstered</li> </ul>		1571	1637	1800	1882	1963	2291	2456
MCM420CV00	Profim COM K42CV <ul style="list-style-type: none"> <li>• barstool</li> <li>• frame: black</li> <li>• fully upholstered</li> </ul>		1951	2032	2236	2335	2438	2844	3047

Item no	Base model +	Price Group (PG)	Price Group						Price
			0	①	②	③	④	⑤	
MCM420HF00	Profim COM K42HF • "spider" frame • frame: black • fully upholstered		2 550	2 656	2 922	3 055	3 188	3 718	3 985
MCM420HS00	Profim COM K42HS • "spider" frame • frame: black • swivel • fully upholstered		2 782	2 898	3 164	3 297	3 429	3 961	4 226
MCM420HC00	Profim COM K42HC • "spider" frame • frame: black • on castors • fully upholstered		2 818	2 936	3 201	3 334	3 468	3 998	4 264
MCM000CTH0	Profim COM CTH • Trolley for transportation								1 543
<b>Accessories/Options/Surcharges:</b>									
7TFRA018	Frame: V1 - cantilever with metal frame (Only for: K12V, K22V, K32V, K42V)								387
7TFRA019	Frame: V2 - reversed cantilever (Only for: K12V, K22V, K32V, K42V)								85
7COPR002	Frames colours: MetallicPro, White RAL 9016, Deep Green RAL 6004, Navy Blue RAL 5003, Burgundy RAL 3005, Salvia/Green RAL 6021, Blue RAL 5014, Terracota RAL 3012 (Only for: K12CV, K12H, K12HC, K12HF, K12HS, K12V, K22CV, K22H, K22HC, K22HF, K22HS, K22V, K32H, K32HC, K32HF, K32HS, K32V, K42CV, K42H, K42HC, K42HF, K42HS, K42V)								31
7COPR003	Frames colours: Lightgrey NCS S 2500-N; Grey NCS S 6500-N, Metalsilver, Steelgray (Only for: K12CV, K12H, K12HC, K12HF, K12HS, K12V, K22CV, K22H, K22HC, K22HF, K22HS, K22V, K32H, K32HC, K32HF, K32HS, K32V, K42CV, K42H, K42HC, K42HF, K42HS, K42V)								141
7COPR006	Frame colour: Gold (Only for: K12HC, K12HF, K12HS, K22HC, K22HF, K22HS, K32HC, K32HF, K32HS, K42HC, K42HF, K42HS)								346
7ARMR001	Armrests (Only for: K12H, K12V, K22CV, K22H, K22V, K32H, K32V, K42H, K42V)								382
7TARM003	Plywood pad for armrest (Only for: K12H, K12V, K22H, K22V, K32H, K32V, K42H, K42V)								185
	HPL LW01 (white), LW02 (black), LW03 (light gray )LW04 (grey), LW06 (dark blue), LW07 (light burgundy )(grey) (Only for: K12CV, K12H, K12HC, K12HF, K12HS, K12V, K22CV, K22H, K22HC, K22HF, K22HS, K22V, K32H, K32HC, K32HF, K32HS, K32V)								534
	Natural veneers Ash (NA), Beech (NB), Oak (NO), Walnut (NW) (Only for: K12CV, K12H, K12HC, K12HF, K12HS, K12V, K22CV, K22H, K22HC, K22HF, K22HS, K22V, K32H, K32HC, K32HF, K32HS, K32V)								348
	Natural colored veneers (ash): White (CNA01), Black (CNA02), Dark green (CNA05), Navy blue (CNA06), Burgundy (CNA07) (Only for: K12CV, K12H, K12HC, K12HF, K12HS, K12V, K22CV, K22H, K22HC, K22HF, K22HS, K22V, K32H, K32HC, K32HF, K32HS, K32V)								348

### Accessories/Options/Surcharges:

7SEQU001	Quilting - pad or front side of the seat (Q1) (Only for: K22CV, K22H, K22HC, K22HF, K22HS, K22V, K32H, K32HC, K32HF, K32HS, K32V)	249
7BAQU001	Quilting - pad or front of the backrest (Q2) (Only for: K32H, K32HC, K32HF, K32HS, K32V)	249
7SHQU004	Quilting - front side of the shell (Q3) (Only for: K42CV, K42H, K42HC, K42HF, K42HS, K42V)	552
7JIRO001	Possibility of joining in rows (Only for: K12H, K12V, K22H, K22V, K32H, K32V, K42H, K42V)	206
7TATO002	Table top 2PB - extra charge: version with armrests (Only for: K12H, K22H, K32H, K42H)	750
7HAND002	Shell with cut-out (C) in upper part of the backrest, enabling moving the chair (Only for: K12H, K12HC, K12HF, K12HS, K12V, K22H, K22HC, K22HF, K22HS, K22V, K32H, K32HC, K32HF, K32HS, K32V)	31

**0 price group: Evo**

**1 price group: Cura, Tonal, Xtreme**

**2 price group: Select**

**3 price group: Capture, Oceanic, Step, Synergy**

**4 price group: Steelcut 3, Steelcut Trio 3**

**6 price group: Paloma**

Colours of plywood - standard colours of lacquer: H6, H12, H5

Natural veneers -Ash (NA), Beech (NB), Oak (NO), Wallnut (NW)

Coloured natural veneers - White Ash CNA01, Black Ash CNA02, Deep Green Ash CNA05 (RAL 6004), Navy Blue Ash CNA06 RAL 5003, Burgundy Ash CNA07 RAL 3005

HPL - White LW01 (RAL 9016), Light Grey LW03 (NCS S 2500-N), Grey LW04 (RAL 7037), Black LW02 (RAL 9011), Navy Blue LW06 (RAL 5003), Light Burgundy LW07 (RAL 3004)

Glides:

- standard - teflon glides (universal),

- option - felt glides (for hard floors).

When ordering please clearly indicate the chosen option.

Armrest pad: Version V1 - plastic pad, always black.

Version Com K12 / K22 / K32 colour and type of plywood pad is always the same as shell.

Versions Com K4 (fully upholstered) armrest plywood pad finishing:

- Colours of plywood - standard colours of lacquer: H6, H12, H5

- Natural veneers -Ash (NA), Beech (NB), Oak (NO), Wallnut (NW)

- Coloured natural veneers - White Ash CNA01, Black Ash CNA02, Deep Green Ash CNA05 (RAL 6004), Navy Blue Ash CNA06 RAL 5003, Burgundy Ash CNA07 RAL 3005

- HPL - White LW01 (RAL 9016), Light Grey LW03 (NCS S 2500-N), Grey LW04 (RAL 7037), Black LW02 (RAL 9011), Navy Blue LW06 (RAL 5003), Light Burgundy LW07 (RAL 3004)

Please clearly indicate the chosen option.

Armrests:

- 2P - metal, polypropylene pad (set) - does not apply to versions V and V2,

- 2P - metal, plywood pad (set) - does not apply to versions V , V1 and V2.

Quilting - extra charge to all price groups, lead time 30-40 working days.



Frame version: V2



Frame version: V1



# Com

Paul Brooks

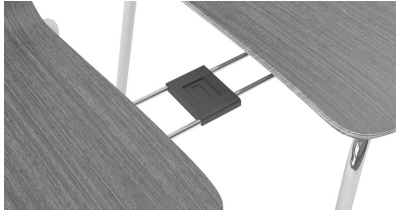

## Joining in rows (H/V)

The linking part is an integral part of the chair, therefore it cannot be purchased and assembled at a later stage. The linking part is suitable for versions: H / H 2P / H 2PB / V.

Linking part is made of stainless steel and black plastic.

The total width of two connected chairs is:

- version H - 1160 mm,
- version H 2P/ H2PB - 1240-1310 mm,
- version V - 1170 mm.



## Joining in rows (V1/V2)

The linking part is suitable for versions: V1 / V1 2P / V2. Always in black.

Total width of two connected chairs:

- version V1 - 985-1075 mm,
- version V1 2P - 1150-1220 mm,
- version V2 - 1165-1245 mm.



## Trolley for transportation (CTH)

Trolley with a handle.

Available colours: black, metallic.

Always with soft castors.

Dimension: 1000 x 1010 x 630 mm



## "Anti-panic" system (APA)\*

"Anti-panic" connectors for chairs without armrests (refers only to the H versions).

Always in black.

Total width of two connected chairs: 1030 mm.



## "Anti-panic" system (APB)\*

"Anti-panic" connectors for chairs with armrests/ armrests with table top (refers only to the H versions).

Always in black.

Total width of two connected chairs: 1220-1290 mm.



## "Anti-panic" system (APD)\*

"Anti-panic" system for connecting rows (refers only to the H versions).

The price is for 1 connector.

Always in black.



## Shell with cut-out (C)

Shell with cut-out in upper part of the backrest, enabling moving the chair. Do not concern versions with shell fully upholstered.



## Table top (2PB)

The table top is an integral part of 2PB models therefore it cannot be purchased separately.







It is assembled on the right side of the chair and is equipped with anti-panic system which prevents blocking the table top in case of sudden movement. It's always black composite.

Maximum table load: 15kg.

# Profim NOOR 4-LEG

StokkeAustad, Form Us With Love, Susanne Grønlund Design and Flokk design team

- Armrests available in matching colours to frame
- Stackable up to 10 chairs, 5 chairs with armrests (upholstered and unupholstered models)
- Table suspension for Profim Noor 6050/55 to Profim Eminent frame table available (See Eminent table)
- Red Dot Design award 2013
- Norwegian Design Council – Award for Design Excellence

Item no	Base model +	Price Group (PG)	Price Group						Price	
			0	①	②	③	④	⑤		⑥
6050	Profim NOOR 6050 • Polypropylene chair									1507
6055	Profim NOOR 6055 • 3D veneer chair • Oak									5277
6050s	Profim NOOR 6050S • Polypropylene chair • Seat upholstery		1687	1737	1776	1862	1916	2162	2445	
6050sb	Profim NOOR 6050sb • Polypropylene chair • Seat + back upholstery		1944	2004	2046	2149	2208	2496	2823	
6050f	Profim NOOR 6050f • Polypropylene chair • Fully upholstered in selected fabrics. See below Accessories/options for complete list		2339	2416	2463	2588	2659	3007		
6055s	Profim NOOR 6055s • 3D veneer chair • Oak • Seat upholstery		5268	5434	5546	5822	5987	6766	7649	



Item no	Base model +	Price Group (PG)	Price Group						Price
			0	①	②	③	④	⑤	
6055sb	Profim NOOR 6055sb • 3D veneer chair • Oak • Seat + back upholstery		5 526	5 701	5 816	6 109	6 281	7 096	8 025

**Accessories/Options/Surcharges:**

3YES	Linking device, welded. Must be specified at time of order. Can not be retrofitted.	79
PD303	Felt glides - 4 units.	65
AR809	Noor armrests pair	683
SH30006	Additional price* for dark stained oak 3D veneer shell (Only for: 6055, 6055s, 6055sb)	323
149285	Chair trolley	2909

**0 price group: Evo\***

**1 price group: Cura, Tonal, Xtreme**

**2 price group: Select**

**3 price group: Capture, Oceanic, Step, Synergy**

**4 price group: Steelcut 3, Steelcut Trio 3**

\*not available for Noor 6050F

6-8 mm polypropylene (PP) and 6.7 mm 3D veneer shells (oak or dark stained oak\*)

16x2 mm 4 leg tubular steel base

Weight: 5.7 kg model 6050, 4.7 kg model 6055

Seat height 439 mm, Back height 357 mm, Chair width 543 mm, Chair width w/armrests 550 mm, Chair height 835 mm, Chair depth 490 mm



S=Standard Collection – normal production time 10-15 working days. Applicable when all component options (fabric, shell, frame/legs) are standard (S).

E=Extended Collection – normal production time 20-30 working days. Applicable when any or all component options selected are extended (E).







For larger orders, please contact Customer Service for delivery details.



# Profim NOOR SLEDGEBASE

StokkeAustad, Form Us With Love, Susanne Grønlund Design and Flokk design team

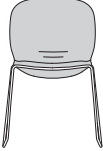
- Armrests available in matching colours to frame
- Stackable up to 10 chairs, 5 chairs with armrests (upholstered and unupholstered models)
- Table suspension for Profim Noor 6060/65 to Profim Eminent frame table available.
- Red Dot Design - 'Best of the best' award winner 2013
- Norwegian Design Council - Award for Design Excellence

Item no	Base model +	Price Group (PG)	Price Group						Price	
			0	①	②	③	④	⑤		⑥
6060	Profim NOOR 6060 • Polypropylene chair									1723
6065	Profim NOOR 6065 • 3D veneer chair • Oak									5493
6060s	Profim NOOR 6060s • Polypropylene chair • Seat upholstery		1889	1947	1988	2088	2148	2424	2743	
6060sb	Profim NOOR 6060sb • Polypropylene chair • Seat + back upholstery		2147	2216	2260	2375	2442	2758	3119	
6060f	Profim NOOR 6060f • Polypropylene chair • Fully upholstered in selected fabrics. See below Accessories/options for complete list		2551	2635	2685	2820	2900	3277		
6065s	Profim NOOR 6065s • 3D veneer chair • Oak • Seat upholstery		5471	5643	5760	6047	6220	7027	7947	

Item no	Base model +	Price Group (PG)	Price Group						Price	
			0	①	②	③	④	⑤		⑥
6065sb	Profim NOOR 6065sb • 3D veneer chair • Oak • Seat + back upholstery		5 731	5 911	6 033	6 332	6 514	7 357	8 323	

**Accessories/Options/Surcharges:**

3YES	Linking device, welded. Must be specified at time of order. Can not be retrofitted.	79
PD303	Felt glides - 4 units.	66
AR809	Noor armrests pair	683
SH30006	Additional price* for dark stained oak 3D veneer shell (Only for: 6065, 6065s, 6065sb)	323
149285	Chair trolley	2909

**0 price group: Evo\***

**1 price group: Cura, Tonal, Xtreme**

**2 price group: Select**

**3 price group: Capture, Oceanic, Step, Synergy**

**4 price group: Steelcut 3, Steelcut Trio 3**

\*not available for Noor 6060F

6-8 mm polypropylene (PP) and 6.7 mm 3D veneer shells (oak or dark stained oak\*) 12 mm steel sledgebase Weight: 6.5 kg model 6060, 6.2 kg model 6065  
Seat height 439 mm, Back height 357 mm, Chair width 557 mm, Chair height 835 mm, Chair depth 525 mm



S=Standard Collection – normal production time 10-15 working days. Applicable when all component options (fabric, shell, frame/legs) are standard (S).

E=Extended Collection – normal production time 20-30 working days. Applicable when any or all component options selected are extended (E).

For larger orders, please contact Customer Service for delivery details.



# Profim NOOR FOOTBASE

StokkeAustad, Form Us With Love, Susanne Grønlund Design and Flokk design team

- Standard gaslift B black
- Seat mechanism and footbase (Ø665 mm) in black painted aluminium as standard.
- Polished aluminium seat mechanism and footbase available as option. Seat mechanism, gaslift and footbase in white lacquered aluminium available as option
- Armrest available in black, white or metal silver
- Table suspension for Profim Noor 6070/75 to Profim Eminent frame table available.
- Red Dot Design Award 2013
- Norwegian Design Council – Award for Design Excellence

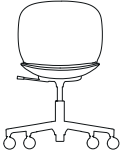
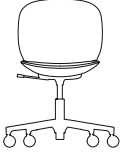
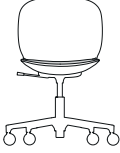
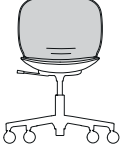
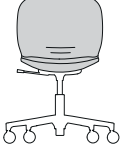
Item no	Base model +	Price Group (PG)	0	①	②	③	④	⑤	⑥	Price
6070	Profim NOOR 6070 • Polypropylene chair									2511
6075	Profim NOOR 6075 • 3D veneer chair • Oak									6281
6070s	Profim NOOR 6070s • Polypropylene chair • Seat upholstery		2642	2724	2781	2918	3003	3390	3835	
6070sb	Profim NOOR 6070sb • Polypropylene chair • Seat + back upholstery		2898	2988	3051	3202	3295	3723	4210	
6070f	Profim NOOR 6070f • Polypropylene chair • Fully upholstered in selected fabrics. See below Accessories/options for complete list		3331	3435	3506	3679	3785	4275		

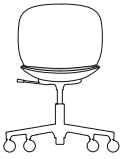
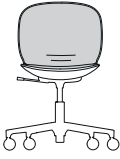
Item no	Base model +	Price Group (PG)	Price Group						Price
			0	①	②	③	④	⑤	
6075s	Profim NOOR 6075s • 3D veneer chair • Oak • Seat upholstery		6 221	6 417	6 549	6 875	7 074	7 992	9 039
6075sb	Profim NOOR 6075sb • 3D veneer chair • Oak • Seat + back upholstery		6 481	6 686	6 822	7 165	7 368	8 322	9 414

#### Accessories/Options/Surcharges:

125182	Glides, 58 mm	0
FB3004	Footbase in polished aluminium	505
FB3013	Footbase alu white 25"	419
AR809	Noor armrests pair	683
SH30006	Additional price* for dark stained oak 3D veneer shell (Only for: 6075, 6075s, 6075sb)	323

0 price group: Evo\*

1 price group: Cura, Tonal, Xtreme

2 price group: Select

3 price group: Capture, Oceanic, Step, Synergy

4 price group: Steelcut 3, Steelcut Trio 3

\*not available for Noor 6070F

6-8 mm polypropylene (PP) and 6.7 mm 3D veneer shells (oak or dark stained oak\*)

Weight: 8.0 kg model 6070, 7.6 kg model 6075

Seat height 355-490 mm, back height 357 mm, chair width and depth 665 mm, chair height 727-857 mm

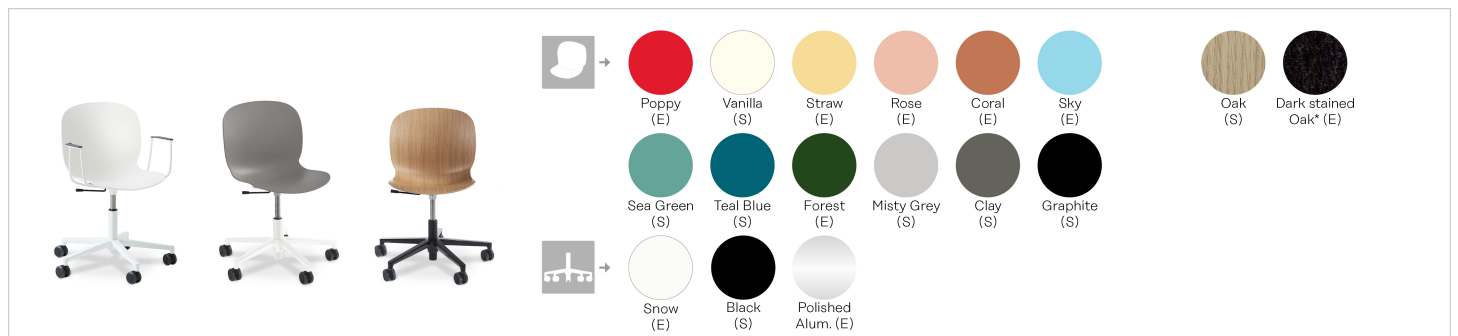

S=Standard Collection – normal production time 10-15 working days. Applicable when all component options (fabric, shell, frame/legs) are standard (S).

E=Extended Collection – normal production time 20-30 working days. Applicable when any or all component options selected are extended (E).







For larger orders, please contact Customer Service for delivery details.



# Profim NOOR WOODEN LEGS

StokkeAustad, Form Us With Love, Susanne Grønlund Design and Flokk design team

- Seat frame in black painted aluminium as standard.
- Wooden legs: natural stained ash as standard.
- Not stackable
- Red Dot Design Award 2013
- Norwegian Design Council – Award for Design Excellence

Item no	Base model +	Price Group (PG)	Price Group						Price	
			0	①	②	③	④	⑤		⑥
6080	Profim NOOR 6080 • Polypropylene chair									3934
6085	Profim NOOR 6085 • 3D veneer chair • Oak									7704
6080s	Profim NOOR 6080s • Polypropylene chair • Seat upholstery		3989	4115	4199	4409	4535	5124	5795	
6080sb	Profim NOOR 6080sb • Polypropylene chair • Seat + back upholstery		4248	4383	4471	4699	4833	5457	6173	
6080f	Profim NOOR 6080f • Polypropylene chair • Fully upholstered in selected fabrics. See below Accessories/options for complete list		4730	4878	4979	5226	5376	6072		
6085s	Profim NOOR 6085s • 3D veneer chair • Oak • Seat upholstery		7573	7812	7971	8372	8608	9725	10998	

Item no	Base model +	Price Group (PG)	Price Group						Price
			0	①	②	③	④	⑤	
6085sb	Profim NOOR 6085sb • 3D veneer chair • Oak • Seat + back upholstery		7 831	8 078	8 243	8 656	8 904	10 057	11 376

**Accessories/Options/Surcharges:**

PD303	Felt glides - 4 units.	65
SH30006	Additional price* for dark stained oak 3D veneer shell (Only for: 6085, 6085s, 6085sb)	323
FC3008	Additional price for seat frame in polished aluminium	143

0 price group: Evo\*

1 price group: Cura, Tonal, Xtreme

2 price group: Select

3 price group: Capture, Oceanic, Step, Synergy

4 price group: Steelcut 3, Steelcut Trio 3

\*not available for Noor 6080F

6-8 mm polypropylene (PP) and 6.7 mm 3D veneer shells (oak or dark stained oak\*)

Weight: 5.4 kg model 6080, 4.6 kg model 6085

Seat height 439 mm, Back height 357 mm, Chair width 490 mm, Chair height 832 mm, Chair depth 480 mm



S=Standard Collection – normal production time 10-15 working days. Applicable when all component options (fabric, shell, frame/legs) are standard (S).

E=Extended Collection – normal production time 20-30 working days. Applicable when any or all component options selected are extended (E).







For larger orders, please contact Customer Service for delivery details.



# Profim NOOR UP

StokkeAustad, based on the design of the RBM Noor of StokkeAustad, Form Us With Love, Susanne Grønlund Design and Flokk design team

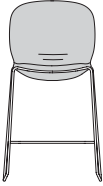
- Suitable for tables around 90 cm high
- Armrests available in matching colours to frame
- Stackable up to 5 chairs

Item no	Base model +	Price Group (PG)	Price Group						Price	
			0	①	②	③	④	⑤		⑥
6090	Profim NOOR UP 6090 • Polypropylene chair									2 349
6095	Profim NOOR UP 6095 • 3D veneer chair • Oak									6 121
6090s	Profim NOOR UP 6090s • Polypropylene chair • Seat upholstery		2 486	2 566	2 617	2 746	2 825	3 194	3 611	
6090sb	Profim NOOR UP 6090sb • Polypropylene chair • Seat + back upholstery		2 744	2 831	2 888	3 033	3 119	3 526	3 986	
6090f	Profim NOOR UP 6090f • Polypropylene chair • Fully upholstered in selected fabrics. See below Accessories/options for complete list		3 168	3 268	3 335	3 505	3 602	4 070		
6095s	Profim NOOR UP 6095s • 3D veneer chair • Oak • Seat upholstery		6 071	6 261	6 390	6 707	6 899	7 792	8 814	



Item no	Base model +	Price Group (PG)	Price Group						Price
			0	①	②	③	④	⑤	
6095sb	Profim NOOR UP 6095sb • 3D veneer chair • Oak • Seat + back upholstery		6 327	6 528	6 660	6 992	7 192	8 126	9 192

**Accessories/Options/Surcharges:**

PD303	Felt glides - 4 units.	66
SH30006	Additional price* for dark stained oak 3D veneer shell (Only for: 6095, 6095s, 6095sb)	323
4107	Noor armrests - pair	744

**0 price group: Evo\***

**1 price group: Cura, Tonal, Xtreme**

**2 price group: Select**

**3 price group: Capture, Oceanic, Step, Synergy**

**4 price group: Steelcut 3, Steelcut Trio 3**

\*not available for Noor 6090F

6-8 mm polypropylene (PP) and 6.7 mm 3D veneer shells (oak or dark stained oak\*)





Weight: 7.7 kg model 6090, 7.2 kg model 6095

12 mm medium-high steel sledgebase

Seat height 630 mm, Back height 357 mm, Chair width 565 mm, Chair height 1025 mm, Chair depth 548 mm



→

							
Poppy (E)	Vanilla (S)	Straw (E)	Rose (E)	Coral (E)	Sky (E)	Oak (S)	Dark stained Oak* (E)
							
Sea Green (S)	Teal Blue (S)	Forest (E)	Misty Grey (S)	Clay (S)	Graphite (S)		
→							
Lingon (E)	Snow (S)	Canola (E)	Rose (E)	Aqua (E)	Sea Green (S)		
							
Teal Blue (S)	Forest (E)	Misty Grey (E)	Black (S)	Metalsilver (S)	Steelgrey (S)		

S=Standard Collection - normal production time 10-15 working days. Applicable when all component options (fabric, shell, frame/legs) are standard (S).

E=Extended Collection - normal production time 20-30 working days. Applicable when any or all component options selected are extended (E).



For larger orders, please contact Customer Service for delivery details.



# Profim NORMO

## Studio Ganszyniec

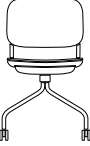
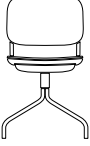
- Chair designed for work and meetings
  - Solid metal construction guarantees stability regardless of intensity of use
  - Our first circular product
  - Manufactured without the use of glue or staples for easy disassembly
  - The seat structure is created from 100% recycled plastic (PP)
  - Normo can be separated/disassembled and recycled up to 94%

Item no	Base model +	Price Group (PG)	Price Group						Price
			0	①	②	③	④	⑤	
MKN500H000	Profim NORMO 500H • 4 legged • seat and backrest upholstered		1679	1864	2135	2221	2483	2477	2861
MKN500HC00	Profim NORMO 500HC • spider' frame on castors • seat and backrest upholstered		2321	2499	2770	2881	3118	3213	3711
MKN500HS00	Profim NORMO 500HS • spider' frame on glides • swivel • seat and backrest upholstered		2491	2676	2947	3064	3280	3419	3949
MKN500V000	Profim NORMO 500V • cantilever • seat and backrest upholstered		1732	1918	2189	2276	2521	2539	2933

### Accessories/Options/Surcharges:

7ARMR020	SP - metal armrests, short	247
7ARMR021	LP - metal armrests, long	294

**0 price group: Evo**

**1 price group: Cura, Tonal, Xtreme**

**2 price group: Select**

**3 price group: Capture, Oceanic, Step, Synergy**

**4 price group: Steelcut 3, Steelcut Trio 3**

Frames colours:

- Black RAL 9005
- MetallicPro
- White RAL 9016

- Lightgrey NCS S 2500-N
- Grey NCS S 6500-N
- Deep green RAL 6004
- Navy blue RAL 5003
- Burgundy RAL 3005
- Salvia/Green RAL 6021
- Blue RAL 5014
- Terracota RAL 3012

Glides:

- teflon glides (universal),
- felt glides (for hard floors).

Castors in HC model:

- universal.

When ordering please clearly indicate the chosen option.



Armrest SP





Armrest LP



# Profim ZOO

## Paul Brooks

- Variety of configurations
- Available in different versions: on four legs, legs with castors or on cantilever, with plastic or upholstered seat, plastic or upholstered backrest, with or without armrests
- Available in three plastic colours (black, grey and light grey) and five frame colours

Item no	Base model +	Price Group (PG)	0	①	②	③	④	⑤	Price
MZO522H000	Profim ZOO 522H • 4-legged • frame: black • plastic seat and backrest								1 408
MZO502H000	Profim ZOO 502H • 4-legged • frame: black • upholstered seat • plastic backrest		1 593	1 732	1 841	1 914	2 266	2 135	
MZO500H000	Profim ZOO 500H • 4-legged • frame: black • upholstered seat and backrest		2 281	2 576	2 878	2 993	3 550	3 338	

### Accessories/Options/Surcharges:

7TFRA005	Frame HC - 4-legged version with castors	403
7CFRA051	Frame: MetallicPro	22
7CFRA010	Frame: grey / lightgrey	
7ARMR001	Armrests	302
7TATO002	Table top	552
7JIRO001	Possibility of joining in rows	216

**0 price group: Evo**

**1 price group: Cura, Tonal, Xtreme**

**2 price group: Select**

**3 price group: Capture, Oceanic, Step, Synergy**

**4 price group: Steelcut 3, Steelcut Trio 3**

Glides:

- standard - teflon glides (universal),
- option - felt glides (for hard floors).

Castors in HC models:

- universal castors

When ordering please clearly indicate the chosen option.

Plastic colours for seats, backrests and armrests:  
black (RAL 9005), grey (NCS S 6500-N), lightgrey (NCS S 2500-N).  
It is possible to freely join the colours of seat, backrest and armrests.

Although in one RAL/NCS, the colour of individual elements of the chair such as seat, backrest, armrests and frame, can vary due to different types of materials used.

Seat cover:

- black frame - cover always black (RAL 9005),
- MetallicPro, RAL/NCS - cover always grey (NCS S 6500-N), except of chairs with black plastic seat - in that case cover is always black (RAL 9005).

In model Zoo 500 without armrests the plastic elements

connecting the frame with backrest are:

- black frame - always black (RAL 9005),
- MetallicPro frame - always grey (NCS S 6500-N),
- grey / lightgrey frame - always in frame colour.



Frame version: HC



# Zoo

Paul Brooks

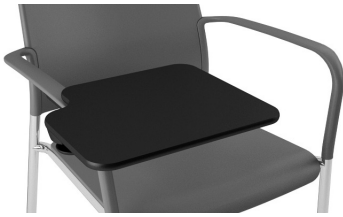

## Table top (2PB)

The table top is an integral part of 2PB models therefore it cannot be purchased separately. It is assembled on the right side of the chair and is equipped with anti-panic system which prevents blocking the table top in case of sudden movement. It's always black composite. Maximum table load: 15 kg.

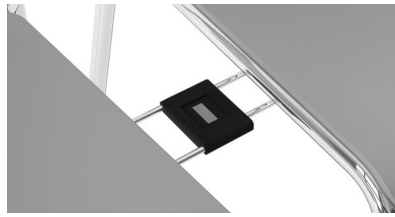

## Joining in rows - 4-legged version

The linking part is an integral part of the chair, therefore it cannot be purchased and assembled at a later stage. The linking part is suitable for versions on 4 legs (H/H 2P/H 2PB). Linking part is made of stainless steel and black plastic. The total width of two connected chairs is:  
- no armrests - 1070 mm,  
- with armrests - 1260 mm.



## „Anti-panic” system (APA)\*

"Anti-panic" connectors for chairs without armrests. Available colours: black, metallic. Total width of two connected chairs: 1120 mm. The anti-panic system meets EN 14703 norm.



## „Anti-panic” system (APB)\*

"Anti-panic" connectors for chairs with armrests. Always in black. Total width of two connected chairs: 1170 mm. The anti-panic system meets EN 14703 norm.



## „Anti-panic” system (APC)\*

"Anti-panic" connectors for chairs with armrests and a table top. Always in black. Total width of two connected chairs: 1350 mm. The anti-panic system meets EN 14703 norm.



## „Anti-panic” system (APD)\*

"Anti-panic" system for connecting rows. The price is for 1 connector. Always in black. The anti-panic system meets EN 14703 norm.



## Trolley for transportation (CTH)

Trolley with a handle. Available colours: black, metallic. Always with soft castors. Dimensions: 1000 x 1000 x 600 mm

Sofas

Armchairs

Modular systems









# Profim CHIC

Christophe Pillet

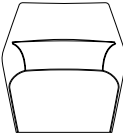
- The seat is equipped with the return memory (it returns to the starting position by itself)
- Restaurant and bar chairs with a range of bases and armchairs with a swivel base or with glides
- Möbelfakta certificate - a guarantee of durability, safety, environmental care and social responsibility during the production process

Item no	Base model +	Price Group (PG)	Price Group						Price
			0	①	②	③	④	⑤	
MCC210H000	Profim CHIC 21H <ul style="list-style-type: none"> <li>• chair</li> <li>• metal legs</li> <li>• frame: MetallicPro; Black RAL 9005; White RAL 9016; Deep Green RAL 6004; Navy Blue RAL 5003; Burgundy RAL 3005; Salvia/Green RAL 6021, Blue RAL 5014; Terracota RAL 3012</li> <li>• without armrests</li> </ul>		3 090	3 219	3 538	3 700	3 861	4 506	4 826
MCC200H000	Profim CHIC 20H <ul style="list-style-type: none"> <li>• chair</li> <li>• metal legs</li> <li>• frame: MetallicPro; Black RAL 9005; White RAL 9016; Deep Green RAL 6004; Navy Blue RAL 5003; Burgundy RAL 3005; Salvia/Green RAL 6021, Blue RAL 5014; Terracota RAL 3012</li> <li>• with armrests</li> </ul>		3 376	3 517	3 871	4 047	4 221	4 925	5 277
MCC200F000	Profim CHIC 20F <ul style="list-style-type: none"> <li>• chair</li> <li>• base: polished aluminium</li> <li>• 4-star base</li> </ul>		3 888	4 050	4 455	4 658	4 860	5 671	6 074
MCC100FU00	Profim CHIC 10FU <ul style="list-style-type: none"> <li>• armchair</li> </ul>		4 936	5 142	5 656	5 912	6 170	7 196	7 712
MCC210CH00	Profim CHIC 21CH <ul style="list-style-type: none"> <li>• bar stool without armrests</li> <li>• metal legs</li> <li>• frame: MetallicPro; Black RAL 9005; White RAL 9016; Deep Green RAL 6004; Navy Blue RAL 5003; Burgundy RAL 3005; Salvia/Green RAL 6021, Blue RAL 5014; Terracota RAL 3012</li> </ul>		3 612	3 763	4 141	4 328	4 517	5 266	5 644
MCC200CH00	Profim CHIC 20CH <ul style="list-style-type: none"> <li>• bar stool</li> <li>• metal legs</li> <li>• frame: MetallicPro; Black RAL 9005; White RAL 9016; Deep Green RAL 6004; Navy Blue RAL 5003; Burgundy RAL 3005; Salvia/Green RAL 6021, Blue RAL 5014; Terracota RAL 3012</li> </ul>		3 901	4 063	4 470	4 673	4 876	5 689	6 096

**Accessories/Options/Surcharges:**

7TFRA011	Frame: HW - wooden legs beech wood - H5, H6, H7, H8, H11, H12 (HW) (Only for: 20H, 21H)	1 946
7TGAS003	Gas lift with memory (Only for: 20F)	534
7TFRA022	Gas lift with memory without height adjustment (Only for: 10FU)	1 289
7COPR003	Frames colours: Lightgrey NCS S 2500-N; Grey NCS S 6500-N , Metalsilver, Steelgray (Only for: 20CH, 20H, 21CH, 21H)	141
7COPR006	Frame colour: Gold (Only for: 20H, 21H)	281

**0 price group: Evo**

**1 price group: Cura, Tonal, Xtreme**

**2 price group: Select**

**3 price group: Capture, Oceanic, Step, Synergy**

**4 price group: Steelcut 3, Steelcut Trio 3**

**6 price group: Paloma**

Glides:

- standard - teflon glides (universal),

- option - felt glides (for hard floors).

When ordering please clearly indicate the chosen option.







Frame version: HW

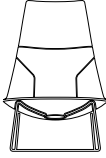
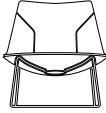
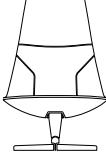

# Profim CHIC LOUNGE

Christophe Pillet

- Characteristic detail in the form of vertical stitching
- Two backrest levels – for different needs and different users
- Possibility to combine leather and fabric in one cover
- Possibility to choose different upholstery colours
- Cushion and footrest increase the comfort of rest
- Attractive price/quality ratio
- Möbelfakta certificate - a guarantee of durability, safety, environmental care and social responsibility during the production process

Item no	Base model +	Price Group (PG)	①	②	③	④	⑤	⑥	Price
MCLA10V300	Profim CHIC LOUNGE A10V3 • armchair • high backrest • wire frame • frame: MetallicPro; Black RAL 9005; White RAL 9016; Deep Green RAL 6004; Navy Blue RAL 5003; Burgundy RAL 3005; Salvia/Green RAL 6021, Blue RAL 5014; Terracota RAL 3012		6 205	6 824	7 135	7 445	8 685	10 589	
MCLA20V300	Profim CHIC LOUNGE A20V3 • armchair • low backrest • wire frame • frame: MetallicPro; Black RAL 9005; White RAL 9016; Deep Green RAL 6004; Navy Blue RAL 5003; Burgundy RAL 3005; Salvia/Green RAL 6021, Blue RAL 5014; Terracota RAL 3012		5 576	6 134	6 413	6 692	7 807	9 205	
MCLA10F000	Profim CHIC LOUNGE A10F • armchair • high backrest • 4-star base • frame: MetallicPro; Black RAL 9005; White RAL 9016; Deep Green RAL 6004; Navy Blue RAL 5003; Burgundy RAL 3005; Salvia/Green RAL 6021, Blue RAL 5014; Terracota RAL 3012		8 004	8 804	9 204	9 606	11 205	12 531	
MCLA20F000	Profim CHIC LOUNGE A20F • armchair • low backrest • 4-star base • frame: MetallicPro; Black RAL 9005; White RAL 9016; Deep Green RAL 6004; Navy Blue RAL 5003; Burgundy RAL 3005; Salvia/Green RAL 6021, Blue RAL 5014; Terracota RAL 3012		7 376	8 113	8 483	8 850	10 328	11 108	
MCLPV30000	Profim CHIC LOUNGE PV3 • footrest • wire frame • frame: MetallicPro; Black RAL 9005; White RAL 9016; Deep Green RAL 6004; Navy Blue RAL 5003; Burgundy RAL 3005; Salvia/Green RAL 6021, Blue RAL 5014; Terracota RAL 3012		3 395	3 734	3 906	4 075	4 752	5 516	
MCLCU00000	Profim CHIC LOUNGE CU • high backrest cushion		574	631	658	688	801	1 161	

---

**Accessories/Options/Surcharges:**

---

7COPR003	Frames colours: Lightgrey NCS S 2500-N; Grey NCS S 6500-N , Metalsilver, Steelgray (Only for: A10F, A10V3, A20F, A20V3, PV3)	141
7COPR006	Frame colour: Gold (Only for: A10F, A20F)	487
7COPR006	Frame colour: Gold (Only for: A10V3, A20V3, PV3)	346

---

**1 price group: Cura, Tonal, Xtreme**

**2 price group: Select**

**3 price group: Capture, Oceanic, Step, Synergy**

**4 price group: Steelcut 3, Steelcut Trio 3**

**6 price group: Paloma**

Glides:

- standard - teflon glides (universal),
- option - felt glides (for hard floors).

When ordering please clearly indicate the chosen option.

Option of mixing colours of the same fabric according to below scheme:

A - inner part of shell colour, B - outer part of shell colour.

In case of order of such option, following example should be specified: SC-67097/SC-60132 (where SC-67097 - A, SC-60132 - B).

Option is available at no extra charge.





In models A10V3/A10F it is possible to order extra cushion for the backrest.

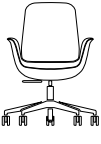

# Profim ELLIE PRO

## ITO Design

- Quick and easy adjustment with the synchro self mechanism (height and tilt adjustment).
- Mechanism fully integrated into the seat
- Possibility of choosing two-colour upholstery
- Several types and colours of bases (four- and five-star bases and metal wire frame or version with wooden legs)
- Blue Angel certificate - confirms that our chair is environmentally friendly

Item no	Base model +	Price Group (PG)	0	①	②	③	④	⑤	Price
MHB100ST00	Profim ELLIE PRO 10ST <ul style="list-style-type: none"> <li>• swivel armchair</li> <li>• Self mechanism</li> <li>• high backrest</li> <li>• 5-star base</li> <li>• base: black</li> </ul>		5 266	5 815	6 739	7 009	9 143	10 176	
MHB200ST00	Profim ELLIE PRO 20ST swivel armchair Self mechanism low backrest 5-star base base: black		5 188	5 404	5 945	6 215	6 486	7 567	
MHB100HS00	Profim ELLIE PRO 10HST <ul style="list-style-type: none"> <li>• swivel armchair</li> <li>• Self mechanism</li> <li>• high backrest</li> <li>• high 4-star base</li> <li>• base: black / MetallicPro / white / polished aluminum</li> </ul>		5 799	6 041	6 646	6 946	7 249	8 457	
MHB200HS00	Profim ELLIE PRO 20 HST <ul style="list-style-type: none"> <li>• swivel armchair</li> <li>• Self mechanism</li> <li>• low backrest</li> <li>• high 4-star base</li> <li>• base: black / MetallicPro / white / polished aluminum</li> </ul>		5 590	5 823	6 406	6 696	6 985	8 151	
MHB100V000	Profim ELLIE PRO 10V3 <ul style="list-style-type: none"> <li>• swivel armchair</li> <li>• Self mechanism</li> <li>• high backrest</li> <li>• wire frame</li> <li>• frame: black / MetallicPro / white</li> </ul>		6 074	6 327	6 959	7 277	7 591	8 857	
MHB200V000	Profim ELLIE PRO 20V3 <ul style="list-style-type: none"> <li>• swivel armchair</li> <li>• Self mechanism</li> <li>• low backrest</li> <li>• wire frame</li> <li>• frame: black / MetallicPro / white</li> </ul>		5 865	6 109	6 719	7 026	7 331	8 552	

Item no	Base model +	Price Group (PG)	0	①	②	③	④	⑤	Price
MHB100HW00	Profim ELLIE PRO 10HW • swivel armchair • Self mechanism • high backrest • wooden legs • frame: beech wood - H5, H6, H12		7 712	8 033	8 839	9 239	9 642	11 249	

MHB200HW00	Profim ELLIE PRO 20HW • swivel armchair • Self mechanism • low backrest • wooden legs • frame: beech wood - H5, H6, H12		7 503	7 815	8 598	8 989	9 379	10 943	
------------	--	---	-------	-------	-------	-------	-------	--------	--

#### Accessories/Options/Surcharges:

7BASC008	Light Gray (Only for: 10ST, 20ST)	76
7TARM006	Upholstered armpad - leather pad on the armrests	137
7COPR003	Frames colours: Lightgrey NCS S 2500-N; Grey NCS S 6500-N (Only for: 10V3, 20V3)	141
7CFRA025	Frame : metalsilver (Only for: 10V3, 20V3)	163
7COPR006	Frame colour: Gold (Only for: 10V3, 20V3)	477

**0 price group: Evo**

**1 price group: Cura, Tonal, Xtreme**

**2 price group: Select**

**3 price group: Capture, Oceanic, Step, Synergy**

**4 price group: Steelcut 3, Steelcut Trio 3**

Castors / glides:

Standard:

- hard castors - for soft floors.

Option:

- soft castors - for hard floors,

- teflon glides - universal,

- felt glides - for hard floors.

When ordering please clearly indicate the chosen option.

In case of armrests with a leather pad, the threads will always be the same as the upholstery inside the shell.

In models HST, V3, HW Self mechanism is not height adjustable.

Option of mixing colours of the same fabric according to below scheme:

A - inner part of shell colour, B - outer part of shell colour.

In case of order of such option, following example should be specified: SC-67097/SC-60132 (where SC-67097 - A, SC-60132 - B). Option is available at no extra charge.









[www.blauer-engel.de/uz117](http://www.blauer-engel.de/uz117)

# Profim FAN

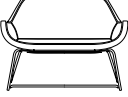
Piotr Kuchciński

- Several types of bases - glides and castors as well as wooden legs which perfectly match the SW40 and Revo tables
- Additional cushion improves comfort of use
- The collection also includes a cantilever sofa
- Two types of thread to choose from (upholstery colour or decorative thread)
- Möbelfakta certificate - a guarantee of durability, safety, environmental care and social responsibility during the production process

Item no	Base model +	Price Group (PG)	Price Group						Price
			0	①	②	③	④	⑤	
MFN100H000	Profim FAN 10H • armchair • 4-legged • frame: black		2 788	2 905	3 341	3 631	3 920	4 356	4 646
MFN100V000	Profim FAN 10V • armchair • cantilever • frame: black		2 972	3 095	3 561	3 869	4 180	4 643	4 952
MFN200V000	Profim FAN 20V • 2-seat sofa • cantilever • frame: black		4 061	4 703	5 585	5 808	7 464	6 490	8 802
MFN100R000	Profim FAN 10R • swivel armchair • round base • Gas lift with memory • base: MetallicPro, Black RAL 9005, White RAL 9016, Deep Green RAL 6004, Navy Blue RAL 5003, Burgundy RAL 3005, Salvia/Green RAL 6021, Blue RAL 5014, Terracota RAL 3012		3 689	4 139	4 548	4 731	5 655	5 314	6 653
MFN100F000	Profim FAN 10F • swivel armchair • 4-star base • base: polished aluminum		4 030	4 440	4 850	5 044	5 956	5 655	6 954
MFN100Z000	Profim FAN 10Z • swivel armchair • Rocker mechanism • base: black		2 978	3 388	3 798	3 949	4 850	4 548	5 825

Item no	Base model +	Price Group (PG)	Price Group						Price
			0	①	②	③	④	⑤	
MFN100E000	Profim FAN 10E swivel armchair Economic mechanism base: black		2 684	3 110	3 520	3 661	4 579	4 270	5 554

MFN1000000	Profim FAN CU • seat cushion for FAN 10 version		406	422	490	695	847	899	954
------------	--	---	-----	-----	-----	-----	-----	-----	-----

#### Accessories/Options/Surcharges:

7TFRA010	Frame: HS - swivel version on glides (Only for: 10H)	273
7TFRA009	Frame: HC - version with castors (Only for: 10H)	328
7TFRA011	Frame: HW - wooden legs - beech wood: H5, H6, H12 (Only for: 10H)	1 211
7COPR002	Frames colours: MetallicPro, White RAL 9016, Deep Green RAL 6004, Navy Blue RAL 5003, Burgundy RAL 3005, Salvia/Green RAL 6021, Blue RAL 5014, Terracota RAL 3012 (Only for: 10H, 10V)	24
7COPR002	Frames colours: MetallicPro, White RAL 9016, Deep Green RAL 6004, Navy Blue RAL 5003, Burgundy RAL 3005, Salvia/Green RAL 6021, Blue RAL 5014, Terracota RAL 3012 (Only for: 20V)	46
7COPR006	Frame colour: Gold (Only for: 10H, 10V)	346
7COPR006	Frame colour: Gold (Only for: 20V)	681
7COPR003	Frames colours: Lightgrey NCS S 2500-N; Grey NCS S 6500-N, Metalsilver, Steelgray (Only for: 10H, 10R, 10V, 20V)	141
7BASC027	Base: MetallicPro (Only for: 10E, 10Z)	247
7BASC003	Base: polished aluminum (Only for: 10Z, 10E)	534
7CPLY010	Oak wood - HO6, HO12, HO11 (Only for: 10H)	216
7TGAS003	Gas lift with memory (Only for: 10F)	570

**0 price group: Evo**

**1 price group: Cura, Tonal, Xtreme**

**2 price group: Select**

**3 price group: Capture, Oceanic, Step, Synergy**

**4 price group: Steelcut 3, Steelcut Trio 3**

**6 price group: Paloma**

Castors / glides

Standard:

- universal castors (model 10HC),
- hard castors (models 10Z/10E),
- teflon glides - universal (models 10F/10H/10HS/10HW),
- hard glides - for soft floors (models 10V/20V).

Option:

- soft castors (models 10Z/10E),
- teflon glides - universal (10Z/10E),
- felt glides - for hard floors (10H/10HS/10HW/10V/20V/10F),
- felt pads under the base - for hard floors (model 10R).

When ordering please clearly indicate the chosen option.

Model 10HW: wooden legs: beech wood - H5, H6, H12,



















Two options of threads:

- upholstery matching threads

- decorative threads:

**DECORATIVE THREADS**

Color name		Approximate color from Pantone®
White		PANTONE 11-0608 TCX
Grey		PANTONE 18-0601 TCX
Dark grey		PANTONE 19-3901 TCX
Black		PANTONE 19-4004 TCX
Dark blue		PANTONE 19-3933 TCX
Blue		PANTONE 17-4139 TCX
Dark green		PANTONE 19-6050 TCX
Green		PANTONE 17-0324 TCX
Neon green		PANTONE 14-0340 TCX
Yellow		PANTONE 17-0949 TCX
Orange		PANTONE 17-1145 TCX
Neon orange		PANTONE 16-1364 TCX
Red		PANTONE 19-1758 TCX
Brown		PANTONE 14-1208 TCX
Beige		PANTONE 19-1218 TCX
Silver		PANTONE 14-4201 TCX

Option is available at no extra charge.



Frame version: 10HC







Frame version: 10HW



# Profim MYTURN SOFA

## Paul Brooks

- The collection includes an armchair and 2- and 3-seater sofas (on cantilever or legs)
- The collection is complemented by tables in two sizes

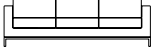
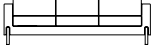
Item no	Base model +	Price Group (PG)	①	②	③	④	⑤	⑥	Price
MEX100H000	Profim MYTURN SOFA 10H • armchair • legs • frame: black		9 259	10 185	10 647	11 111	12 960	13 886	
MEX100V000	Profim MYTURN SOFA 10V • armchair • cantilever • frame: black		9 846	10 828	11 321	11 814	13 781	14 767	
MEX200H000	Profim MYTURN SOFA 20H • 2-seat sofa • legs • frame: black		12 941	14 234	14 881	15 526	18 117	19 410	
MEX200V000	Profim MYTURN SOFA 20V • 2-seat sofa • cantilever • frame: black		13 266	14 593	15 256	15 920	18 573	19 902	
MEX300H000	Profim MYTURN SOFA 30H • 3-seat sofa • legs • frame: black		16 484	18 132	18 957	19 781	23 079	24 728	
MEX300V000	Profim MYTURN SOFA 30V • 3-seat sofa • cantilever • frame: black		16 757	18 434	19 270	20 109	23 460	25 136	

### Accessories/Options/Surcharges:

7QUEL006	Quilting - outer surface (Q7) (Only for: 10H, 10V)								844
----------	--	--	--	--	--	--	--	--	-----

**Accessories/Options/Surcharges:**

7QUEL006	Quilting - outer surface (Q7) (Only for: 20H, 20V)	1 238
7QUEL006	Quilting - outer surface (Q7) (Only for: 30H, 30V)	1 439
7CFRA051	Frame: MetallicPro	31

**1 price group: Cura, Tonal, Xtreme**

**2 price group: Select**

**3 price group: Capture, Oceanic, Step, Synergy**

**4 price group: Steelcut 3, Steelcut Trio 3**

**6 price group: Paloma**

Glides

Standard:

- hard glides - for soft floors (models 10H/20H/30H),

- felt pads - for hard floors (models 10V/20V/30V).

Option:

- felt glides - for hard floors (models 10H/20H/30H).





When ordering please clearly indicate the chosen option.

Quilting - extra charge to all price groups, lead time 30-40 working days.

# Profim MYTURN TABLE

## Paul Brooks

- Tables in two sizes
- On cantilever or legs

Item no	Base model +	Price Group (PG)	①	②	Price
MEXS20H000	Profim MYTURN TABLE S2H • small table • 850 x 300 x 850 mm • legs • frame: black		7 145	7 859	
MEXS20V000	Profim MYTURN TABLE S2V • small table • 850 x 300 x 850 mm • cantilever • frame: black		8 181	8 999	
MEXS10H000	Profim MYTURN TABLE S1H • large table • 1200 x 300 x 850 mm • legs • frame: black		8 018	8 819	
MEXS10V000	Profim MYTURN TABLE S1V • large table • 1200 x 300 x 850 mm • cantilever • frame: black		9 054	9 959	

### Accessories/Options/Surcharges:

7CFRA051	Frame: MetallicPro				31
----------	--------------------	--	--	--	----

### 1. Natural modified veneers (HM)

#### 2.HPL

Colours of natural modified veneers (HM): HM10 (bleached oak), HM11 (classic oak), HM12 (cardinal oak), HM20 (venge classic) - lead time 20-30 working days.

Colours of HPL (LW): LW01 (white), LW02 (black), LW04 (grey) - lead time 20-30 working days.

#### Glides

##### Standard:

- hard glides - for soft floors (models S2H/S1H)
- felt pads - for hard floors (models S2V/S1V)

##### Option:





- felt glides - for hard floors (models S2H/S1H)

When ordering please clearly indicate the chosen option.

# Profim NU

## Paul Brooks

- The inner and outer sections of the shell may have different coloured fabrics
- The shell is mounted on several types of bases
- The cushion will increase the comfort of rest
- Möbelfakta certificate - a guarantee of durability, safety, environmental care and social responsibility during the production process

Item no	Base model +	Price Group (PG)	Price Group						Price
			0	①	②	③	④	⑤	
MNU200H000	Profim NU 20H • armchair • swivel • 4-legged • frame: black		3 612	3 763	4 141	4 328	4 517	5 266	7 828
MNU200V000	Profim NU 20V3 • armchair • wire frame • frame: black		3 534	3 681	4 050	4 234	4 418	5 154	7 667
MNU200R000	Profim NU 20R • swivel armchair • round base • base: MetallicPro, White RAL 9016, Deep Green RAL 6004, Navy Blue RAL 5003, Burgundy RAL 3005, Salvia/Green RAL 6021, Blue RAL 5014, Terracota RAL 3012		4 626	5 036	5 516	5 736	7 178	8 329	9 542
MNU200F000	Profim NU 20F • swivel armchair • 4-star base • base: polished aluminum		4 738	4 936	5 428	5 675	5 924	6 910	10 023

### Accessories/Options/Surcharges:

7TFRA009	Frame: HC - version with castors - white / graphite / polished aluminum (Only for: 20H)	454
7TFRA011	Frame: HW - wooden legs - beech wood: H5, H6, H12 (Only for: 20H)	831
7COPR006	Frame colour: Gold (Only for: 20H, 20V3)	346
7SHQU006	Quilting - front side of the seat (Q5)	324
7TGAS003	Gas lift with memory (Only for: 20F, 20R)	549
7CFRA048	Frame: Blue RAL 5014 (Only for: 20H)	31
7CFRA033	Frame: Burgundy RAL 3005 (Only for: 20H)	31
7CFRA034	Frame: Deep green RAL 6004 (Only for: 20H)	31
7CFRA039	Frame: Grey NCS S 6500-N (Only for: 20H)	141
7CFRA040	Frame: Lightgrey NCS S 2500-N (Only for: 20H)	141

### Accessories/Options/Surcharges:

7CFRA051	Frame: MetallicPro (Only for: 20H)	31
7CFRA046	Frame: Navy blue RAL 5003 (Only for: 20H)	31
7CFRA047	Frame: Salvia/Green RAL 6021 (Only for: 20H)	31
7CFRA049	Frame: Terracota RAL 3012 (Only for: 20H)	31
7CFRA056	Frame: White RAL 9016 (Only for: 20H)	31
7COPR003	Frames colours: Lightgrey NCS S 2500-N; Grey NCS S 6500-N (Only for: 20R, 20V3)	141
7COPR002	Frames colours: MetallicPro, White RAL 9016, Deep Green RAL 6004, Navy Blue RAL 5003, Burgundy RAL 3005, Salvia/Green RAL 6021, Blue RAL 5014, Terracota RAL 3012 (Only for: 20V3)	31

**0 price group: Evo**

**1 price group: Cura, Tonal, Xtreme**

**2 price group: Select**

**3 price group: Capture, Oceanic, Step, Synergy**

**4 price group: Steelcut 3, Steelcut Trio 3**

Glides

Standard:

- teflon glides – universal (models 20HS/20HW/20V3/20F).

Option:

- hard castors - for soft floors (model 20H/20HC),

- soft castors - for hard floors (model 20H/20HC),

- teflon glides – universal (models 20H/20HS, 20HW),

- felt glides - for hard floors

When ordering please clearly indicate the chosen option.

Model 20HW: wooden legs: beech wood - H5, H6, H12.

Option of mixing colours of the same fabric according to below scheme:

A - cushion, B - inner part of the shell, C - outer part of the shell.

In case of order of such option, following example should be specified: SC-67097/SC-60132/SC-60999 (where SC-67097 - A, SC-60132 - B, SC-60999 - C).

Option is available at no extra charge.

Quilting - extra charge to all price groups, lead time 30-40 working days.



Frame version: 20HC



Frame version: 20HW



# Profim OCTOBER

Hilary Birkbeck

- Rich colours of finishes
- Possibility to use wooden legs
- Quilted cushions on the seat and backrest, finished with buttons
- Coffee tables come in two sizes, with a choice of two types of tops (wooden or wooden with glass insert)

Item no	Base model +	Price Group (PG)	①	②	③	④	⑤	⑥	Price
MOC1000000	Profim OCTOBER 10 • 1-seat pouffe • metal legs • frame: black		5 910	6 327	6 581	7 929	7 248	8 718	
MOC1100000	Profim OCTOBER 11 • armchair • metal legs • frame: black		8 385	9 051	9 412	11 889	12 237	16 290	
MOC1200000	Profim OCTOBER 12 • armchair • high backrest • metal legs • frame: black		10 040	10 946	11 384	15 455	15 401	21 443	
MOC2000000	Profim OCTOBER 20 • metal legs • frame: black		7 573	8 253	8 584	11 023	10 319	13 150	
MOC2100000	Profim OCTOBER 21 • 2-seat sofa • metal legs • frame: black		11 371	12 447	12 944	16 809	18 472	24 969	
MOC2200000	Profim OCTOBER 22 • 2-seat sofa • high backrest • metal legs • frame: black		13 723	15 061	15 663	21 388	22 580	31 452	

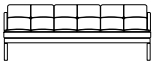

Item no	Base model +	Price Group (PG)	①	②	③	④	⑤	⑥	Price
MOC3100000	Profim OCTOBER 31 • 3-seat sofa • metal legs • frame: black		14 109	15 649	16 275	21 736	22 580	31 188	

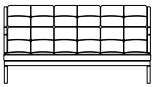
MOC3200000	Profim OCTOBER 32 • 3-seat sofa • high backrest • metal legs • frame: black		17 815	19 547	20 329	27 940	30 639	43 759	
------------	---	---	--------	--------	--------	--------	--------	--------	--

#### Accessories/Options/Surcharges:

7CFRA006	Frame: wood - beech wood: H5, H6, H12	1 238
7CFRA051	Frame: MetallicPro	8

**1 price group: Cura, Tonal, Xtreme**

**2 price group: Select**

**3 price group: Capture, Oceanic, Step, Synergy**

**4 price group: Steelcut 3, Steelcut Trio 3**

**6 price group: Paloma**

Glides

Standard:

- without glides - metal legs,

- hard glides - for soft floors - wooden legs.

Option:

-felt glides - for hard floors.

When ordering please clearly indicate the chosen option.

Wooden legs - standard colours of lacquer (H5, H6, H12) - lead time 20-30 working days.

Option of mixing colours of the same fabric on cushions and shell according to below scheme:

A - cushions on the seat and back, B - shell.



In case of order of such option, following example should be specified: SC-67097/SC-60132 (where SC-67097 - A, SC-60132 - B). Option is available at no extra charge.

Colour of buttons is always the same as the colour of cushions upholstery.

# Profim OCTOBER TABLE

Hilary Birkbeck

- Two sizes and two types of tops (wooden or wooden with glass insert)

Item no	Base model +	Price Group (PG)	①	②	Price
MOCS200000	Profim OCTOBER TABLE S2 <ul style="list-style-type: none"> <li>• small table</li> <li>• 600 x 350 x 600 mm</li> <li>• metal legs</li> <li>• frame: black</li> </ul>		6 907	7 286	
MOCS100000	Profim OCTOBER TABLE S1 <ul style="list-style-type: none"> <li>• large table</li> <li>• 600 x 350 x 1200 mm</li> <li>• metal legs</li> <li>• frame: black</li> </ul>		8 470	8 888	
<b>Accessories/Options/Surcharges:</b>					
7CFRA003	Frame: metallic				
7CFRA006	Frame: wood - beech wood: H5, H6, H12				1 238

## 1. Wood

## 2. Wood/tempered glass (G1)

Wooden legs - standard colours of lacquer (H5, H6, H12) - lead time 20-30 working days.

Glides

Standard:

- without glides - metal legs,
- hard glides - for soft floors - wooden legs.

Option:

- felt glides - for hard floors.







When ordering please clearly indicate the chosen option.

# Profim REVO

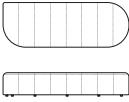
Pearson Lloyd

- Represents a radical rethinking of the way office furniture is made.
- Created from recycled and infinitely recyclable REPP, instead of plywood
- Includes sofas, benches, screens, stools and tables in softly contoured, organic shapes
- With 96 configurations can be customised to suit every workspace, whatever its function or size
- The weight of the product is reduced by 40% lowering the carbon footprint during production and transportation by 13% and 40% respectively.
- Manufactured without the use of glue or staples for easy disassembly

Item no	Base model +	Price Group (PG)	0	①	②	③	④	⑤	⑥	Price
MRVP400000	Profim REVO P40 • Pouffe, • Ø 40 cm	 	3 687	3 841	4 225	4 418	4 609	5 378	7 880	
MRVP600000	Profim REVO P60 • Pouffe, • Ø 60 cm	 	4 462	4 648	5 114	5 347	5 580	6 509	9 744	
MRVSN15000	Profim REVO SN150 • Seat narrow, • lenght 150 cm	 	8 671	9 032	9 935	10 388	10 840	12 645	18 077	
MRVSN21000	Profim REVO SN210 • Seat narrow, • lenght 210 cm	 	11 105	11 568	12 724	13 302	13 881	16 195	23 216	
MRVSW12000	Profim REVO SW120 • Seat wide, • lenght 120 cm	 	9 182	9 565	10 520	10 998	11 477	13 390	19 024	
MRVSW18000	Profim REVO SW180 • Seat wide, • lenght 180 cm	 	12 221	12 730	14 003	14 638	15 275	17 821	25 328	

Item no	Base model +	Price Group (PG)	Price Group						Price
			0	①	②	③	④	⑤	
MRVSW24000	Profim REVO SW240 • Seat wide, • lenght 240 cm		15 175	15 807	17 388	18 177	18 967	22 130	31 436
MRVB900000	Profim REVO B90 • Backrest, • lenght 90 cm		3 295	3 432	3 774	3 946	4 118	4 804	7 014
MRVB120000	Profim REVO B120 • Backrest, • lenght 120 cm		3 943	4 107	4 518	4 724	4 929	5 749	8 374
MRVB180000	Profim REVO B180 • Backrest, • lenght 180 cm		5 610	5 844	6 428	6 721	7 013	8 182	11 938
MRVW900000	Profim REVO W90 • Screen, • wide 90 cm		4 761	4 959	5 455	5 702	5 950	6 943	10 588
MRVW120000	Profim REVO W120 • Screen, • wide 120 cm		6 046	6 298	6 929	7 243	7 558	8 818	13 503
MRVW180000	Profim REVO W180 • Screen, • wide 180 cm		8 075	8 412	9 255	9 675	10 095	11 777	18 437

### Accessories/Options/Surcharges:

7ELEC004	Mediaport - electrical outlet 230V and USB-C (Only for: P60, SN150, SN210, SW120, SW180, SW240)	1 813
7TFOA003	Flame retardant foam BS 5852 (Only for: B120, B180, B90, P40, P60, SN150, SN210, SW120, SW180, SW240)	538

**0 price group: Evo**

**1 price group: Cura, Tonal, Xtreme**

**2 price group: Select**

**3 price group: Capture, Oceanic, Step, Synergy**

**4 price group: Steelcut 3, Steelcut Trio 3**

For Valencia and Silvertex (extended) fabrics - no quilting on the seat modules

Individual modules allow to create various types of systems / sets depending on your needs. A full list of possible configurations is available through the configurator on the website [www.proffim.eu](http://www.proffim.eu) or directly at the link: [CONFIGURATOR pCon](#).

The price for a configured set is the amount of the value of each module of a given set.

Possibility to freely choose the type of upholstery for individual elements within a given set (e.g. seat: Select, backrest: Synergy, screen: Sprint).

The screens can only be combined with wide seats: SW120, SW160 or SW240.

It is not possible to purchase the screen as a free-standing module.







[www.blauer-engel.de/uz117](http://www.blauer-engel.de/uz117)

# Profim SNAP

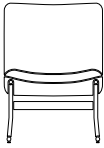
## Note Design Studio

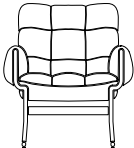
- Snap armchair epitomizes comfort and style, designed to maximize user comfort.
- Snap collection offers two distinct aesthetics: the softer and more expressive Fluffy (21H) and the slim and delicate Slim (20H).
- Designed to support the body and promote well-being in the workplace, Snap enhances employee productivity.
- Created with sustainability in mind, Snap employs innovative technologies and environmentally friendly materials, minimizing the negative impact on the planet while maintaining high quality and durability.
- Snap is certified by the EU Ecolabel, Möbelfakta, Greenguard, and EPD.
- The seat is composed of up to 75% recycled polypropylene, while the back is made of up to 70% recycled polyamide. The carbon footprint of the Slim 20H version is 49.38 kg, and the Fluffy 21H version is 53.31 kg.

Item no	Base model +	Price Group (PG)	Price Group						Price	
			0	①	②	③	④	⑤		⑥
MNL200H000	Profim SNAP 20H <ul style="list-style-type: none"> <li>• lounge chair</li> <li>• slim version</li> <li>• without armrests</li> <li>• upholstered seat and backrest</li> <li>• metal legs</li> <li>• frame: MetallicPro; Black RAL 9005; White RAL 9016; Deep Green RAL 6004; Navy Blue RAL 5003; Burgundy RAL 3005; Salvia/Green RAL 6021; Blue RAL 5014; Terracota RAL 3012</li> </ul>		5 866	6 192	6 518	7 756	8 669	9 842	11 276	
MNL210H000	Profim SNAP 21H <ul style="list-style-type: none"> <li>• lounge chair</li> <li>• fluffy version</li> <li>• without armrests</li> <li>• upholstered seat and backrest, with additional cushions</li> <li>• metal legs</li> <li>• frame: MetallicPro; Black RAL 9005; White RAL 9016; Deep Green RAL 6004; Navy Blue RAL 5003; Burgundy RAL 3005; Salvia/Green RAL 6021, Blue RAL 5014; Terracota RAL 3012</li> </ul>		7 821	8 256	8 690	10 341	11 558	13 122	15 034	
MNL210HP00	Profim Snap 21H 2PF <ul style="list-style-type: none"> <li>• lounge chair</li> <li>• fluffy version</li> <li>• metal armrests</li> <li>• upholstered armrest covers</li> <li>• upholstered seat and backrest, with additional cushions</li> <li>• metal legs</li> <li>• frame: MetallicPro; Black RAL 9005; White RAL 9016; Deep Green RAL 6004; Navy Blue RAL 5003; Burgundy RAL 3005; Salvia/Green RAL 6021, Blue RAL 5014; Terracota RAL 3012</li> </ul>		9 796	10 490	11 292	13 178	15 764	17 780	21 152	
MNL0000000	Profim SNAP F <ul style="list-style-type: none"> <li>• upholstered armrest covers</li> <li>• separate element</li> <li>• applied only in 21H 2P version (with armrests)</li> </ul>		997	1 256	1 624	1 859	3 228	3 680	5 140	
<b>Accessories/Options/Surcharges:</b>										
7ARMR023	2P - Metal armrests (Only for: 20H, 21H)									978
7CFRA025	Frame : metalsilver (Only for: 20H, 21H, 21H 2PF)									163
7CFRA039	Frame: Grey NCS S 6500-N (Only for: 20H, 21H, 21H 2PF)									141

**Accessories/Options/Surcharges:**

---

7CFRA040

Frame: Lightgrey NCS S 2500-N (Only for: 20H, 21H, 21H 2PF)

141

---

**0 price group: Evo**

**1 price group: Cura, Tonal, Xtreme**

**2 price group: Select**

**3 price group: Capture, Oceanic, Step, Synergy**

**4 price group: Steelcut 3, Steelcut Trio 3**

**6 price group: Paloma**

Glides:

- standard - teflon glides (universal),

- option - felt glides (for hard floors).

When ordering please clearly indicate the chosen option.

Glides colour matched to frame colour:

**White:** Metalsilver; MetallicPro; White / RAL 9016; Light Grey / NCS S 2500 N; Salvia/Green / RAL 6021; Blue / RAL 5014; Terracota / RAL 3012

**Black:** Black / RAL 9005; Grey / NCS S 6500 N; Deep Green / RAL 6004; Navy Blue / RAL 5003; Burgundy / RAL 3005

2P - metal armrest always in the same color as the armchair frame

Upholstered armrest covers always in the same fabric as chair.

Snap F - It is possible to purchase an armrest covers later for self-assembly.







# Profim SOFTBOX

## Paul Brooks

- Modular system
- Aluminium legs with original shape
- Screens enabling space separation and improving acoustic conditions in rooms
- Possibility to choose different upholstery colours
- Stabilizing connectors for neighbouring elements included

Item no	Base model +	Price Group (PG)	①	②	③	④	⑤	⑥	Price
MSF1000000	Profim SOFTBOX 10 • pouffe • frame: black		8 140	8 955	9 361	9 770	11 395	12 210	
MSF1C00000	Profim SOFTBOX 1C • corner armchair • frame: black		10 689	11 758	12 294	12 827	14 965	16 036	
MSF1C00W00	Profim SOFTBOX 1CW • to assemble with screen • prices the same as the model 1C (MSF1C00000) • add the price of the screen from the accessory list								
MSF1100000	Profim SOFTBOX 11 • armchair • frame: black		11 957	13 153	13 752	14 350	16 741	17 937	
MSF1100W00	Profim SOFTBOX 11W • to assemble with screen • prices the same as the model 11 (MSF1100000) • add the price of the screen from the accessory list								
MSF2000000	Profim SOFTBOX 20 • 2-seat pouffe • frame: black		10 608	11 669	12 199	12 731	14 852	15 914	

Item no	Base model +	Price Group (PG)	①	②	③	④	⑤	⑥	Price
MSF2B00000	Profim SOFTBOX 2B <ul style="list-style-type: none"> <li>• 2-seat sofa</li> <li>• frame: black</li> <li>• without armrests</li> </ul>		13 884	14 805	15 397	18 410	18 897	36 572	
MSF2B00W00	Profim SOFTBOX 2BW <ul style="list-style-type: none"> <li>• to assemble with screen</li> <li>• prices the same as the model 2B (MSF2B00000)</li> <li>• add the price of the screen from the accessory list</li> </ul>								
MSF2R00000	Profim SOFTBOX 2R <ul style="list-style-type: none"> <li>• 2-seat sofa</li> <li>• frame: black</li> <li>• armrest on right side</li> </ul>		15 202	16 724	17 484	18 244	21 285	22 804	
MSF2R00W00	Profim SOFTBOX 2RW <ul style="list-style-type: none"> <li>• to assemble with screen</li> <li>• prices the same as the model 2R (MSF2R00000)</li> <li>• add the price of the screen from the accessory list</li> </ul>								
MSF2L00000	Profim SOFTBOX 2L <ul style="list-style-type: none"> <li>• 2-seat sofa</li> <li>• frame: black</li> <li>• armrest on left side</li> </ul>		15 202	16 724	17 484	18 244	21 285	22 804	
MSF2L00W00	Profim SOFTBOX 2LW <ul style="list-style-type: none"> <li>• to assemble with screen</li> <li>• prices the same as the model 2L (MSF2L00000)</li> <li>• add the price of the screen from the accessory list</li> </ul>								
MSF2100000	Profim SOFTBOX 21 <ul style="list-style-type: none"> <li>• 2-seat sofa</li> <li>• frame: black</li> <li>• with armrests</li> </ul>		15 775	17 354	18 142	18 930	22 088	23 665	

Item no	Base model +	Price Group (PG)	①	②	③	④	⑤	⑥	Price
MSF2100W00	Profim SOFTBOX 21W • to assemble with screen • prices the same as the model 21 (MSF2100000) • add the price of the screen from the accessory list								
MSF3B00000	Profim SOFTBOX 3B • 3-seat sofa • frame: black • without armrests		18 053	19 857	20 762	21 664	25 274	27 079	
MSF3B00W00	Profim SOFTBOX 3BW • to assemble with screen • prices the same as the model 3B (MSF3B00000) • add the price of the screen from the accessory list								
MSF3R00000	Profim SOFTBOX 3R • 3-seat sofa • frame: black • armrest on right side		19 676	21 641	22 625	23 611	27 546	29 514	
MSF3R00W00	Profim SOFTBOX 3RW • to assemble with screen • prices the same as the model 3R (MSF3R00000) • add the price of the screen from the accessory list								
MSF3L00000	Profim SOFTBOX 3L • 3-seat sofa • frame: black • armrest on left side		19 676	21 641	22 625	23 611	27 546	29 514	
MSF3L00W00	Profim SOFTBOX 3LW • to assemble with screen • prices the same as the model 3L (MSF3L00000) • add the price of the screen from the accessory list								

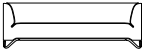
Item no	Base model +	Price Group (PG)	①	②	③	④	⑤	⑥	Price
MSF3100000	Profim SOFTBOX 31 • 3-seat sofa • frame: black • with armrests		20 302	22 333	23 349	24 364	28 423	30 454	

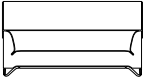
MSF3100W00	Profim SOFTBOX 31W • to assemble with screen • prices the same as the model 31 (MSF3100000) • add the price of the screen from the accessory list								
------------	--	---	--	--	--	--	--	--	--

MSFS200000	Profim SOFTBOX TABLE S2 • square table • frame: black		9 324	10 137	10 544	10 951	12 579	13 393	
------------	---	---	-------	--------	--------	--------	--------	--------	--

#### Accessories/Options/Surcharges:

7CFRA005	Frame: polished aluminum (Only for: 10, 11, 11W, 1C, 1CW, S2)								921
7CFRA005	Frame: polished aluminum (Only for: 20, 21, 21W, 2B, 2BW, 2L, 2LW, 2R, 2RW)								2 104
7CFRA005	Frame: polished aluminum (Only for: 31, 31W, 3B, 3BW, 3L, 3LW, 3R, 3RW)								3 326
7CFRA006	Frame: wood - H6, H12, H5 (Only for: 10, 11, 11W, 1C, 1CW, S2)								4 248
7CFRA006	Frame: wood - H6, H12, H5 (Only for: 20, 21, 21W, 2B, 2BW, 2L, 2LW, 2R, 2RW)								5 846
7CFRA006	Frame: wood - H6, H12, H5 (Only for: 31, 31W, 3B, 3BW, 3L, 3LW, 3R, 3RW)								7 391
	Table top HPL (LW): LW01 (white), LW02 (black), LW04 (grey) (Only for: S2)								1 384
	Table top - natural modified veneers (HM): HM10 (bleached oak), HM11 (classic oak), HM12 (cardinal oak), HM20 (venge classic) (Only for: S2)								1 384
	Screen (W) - extra charge to 1 price group (Only for: 11W)								4 665
	Screen (W) - extra charge to 1 price group (Only for: 1CW)								4 525
	Screen (W) - extra charge to 1 price group (Only for: 21W)								6 629
	Screen (W) - extra charge to 1 price group (Only for: 2BW)								5 175
	Screen (W) - extra charge to 1 price group (Only for: 2LW, 2RW)								5 802
	Screen (W) - extra charge to 1 price group (Only for: 31W)								7 178
	Screen (W) - extra charge to 1 price group (Only for: 3BW)								5 739
	Screen (W) - extra charge to 1 price group (Only for: 3LW, 3RW)								6 444
	Screen (W) - extra charge to 2 price group (Only for: 11W)								5 283
	Screen (W) - extra charge to 2 price group (Only for: 1CW)								4 950
	Screen (W) - extra charge to 2 price group (Only for: 21W)								7 449
	Screen (W) - extra charge to 2 price group (Only for: 2BW)								5 747
	Screen (W) - extra charge to 2 price group (Only for: 2LW, 2RW)								6 444

**Accessories/Options/Surcharges:**

	Screen (W) - extra charge to 2 price group (Only for: 31W)	8 114
	Screen (W) - extra charge to 2 price group (Only for: 3BW)	6 413
	Screen (W) - extra charge to 2 price group (Only for: 3LW, 3RW)	7 194
	Screen (W) - extra charge to 3 price group (Only for: 11W)	5 283
	Screen (W) - extra charge to 3 price group (Only for: 1CW)	4 950
	Screen (W) - extra charge to 3 price group (Only for: 21W)	7 449
	Screen (W) - extra charge to 3 price group (Only for: 2BW)	5 747
	Screen (W) - extra charge to 3 price group (Only for: 2LW, 2RW)	6 444
	Screen (W) - extra charge to 3 price group (Only for: 31W)	8 114
	Screen (W) - extra charge to 3 price group (Only for: 3BW)	6 413
	Screen (W) - extra charge to 3 price group (Only for: 3LW, 3RW)	7 194
	Screen (W) - extra charge to 4 price group (Only for: 11W)	6 668
	Screen (W) - extra charge to 4 price group (Only for: 1CW)	6 274
	Screen (W) - extra charge to 4 price group (Only for: 21W)	9 530
	Screen (W) - extra charge to 4 price group (Only for: 2BW)	7 140
	Screen (W) - extra charge to 4 price group (Only for: 2LW, 2RW)	8 114
	Screen (W) - extra charge to 4 price group (Only for: 31W)	10 806
	Screen (W) - extra charge to 4 price group (Only for: 3BW)	8 277
	Screen (W) - extra charge to 4 price group (Only for: 3LW, 3RW)	9 483
	Screen (W) - extra charge to 5 price group (Only for: 11W)	7 977
	Screen (W) - extra charge to 5 price group (Only for: 1CW)	7 475
	Screen (W) - extra charge to 5 price group (Only for: 21W)	11 248
	Screen (W) - extra charge to 5 price group (Only for: 2BW)	8 679
	Screen (W) - extra charge to 5 price group (Only for: 2LW, 2RW)	9 730
	Screen (W) - extra charge to 5 price group (Only for: 31W)	12 253
	Screen (W) - extra charge to 5 price group (Only for: 3BW)	9 683
	Screen (W) - extra charge to 5 price group (Only for: 3LW, 3RW)	10 862
	Screen (W) - extra charge to 6 price group (Only for: 11W)	9 139
	Screen (W) - extra charge to 6 price group (Only for: 1CW)	8 563
	Screen (W) - extra charge to 6 price group (Only for: 21W)	12 886
	Screen (W) - extra charge to 6 price group (Only for: 2BW)	9 943
	Screen (W) - extra charge to 6 price group (Only for: 2LW, 2RW)	11 148
	Screen (W) - extra charge to 6 price group (Only for: 31W)	14 038
	Screen (W) - extra charge to 6 price group (Only for: 3BW)	11 094
	Screen (W) - extra charge to 6 price group (Only for: 3LW, 3RW)	12 444
7ELEC004	Mediaport - electrical outlet 230V and USB-C (Only for: 2L, 2LW, 2R, 2RW, 3L, 3LW, 3R, 3RW)	1 841
7ELEC003	Mediaport (mounted on the right side) - electrical outlet 230V and USB-C (Only for: 1C)	1 841
7ELEC001	Mediaport (mounted on the left side) - electrical outlet 230V and USB-C (Only for: 1C)	1 841

**1 price group: Cura, Tonal, Xtreme**

**2 price group: Select**

**3 price group: Capture, Oceanic, Step, Synergy**

**4 price group: Steelcut 3, Steelcut Trio 3**

**6 price group: Paloma**

Glides

Standard:

- teflon glides - universal.

Option:

- felt glides - for hard floors.

When ordering please clearly indicate the chosen option.

Table top G1 - lead time 20-30 working days.

Option of mixing colours of the same fabric on cushions and shell according to below scheme:

A - inner shell part, B - outer shell part.

In case of order of such option, following example should be specified: SC-67097/SC-60132 (where SC-67097 - A, SC-60132 - B). Option is available at no extra charge.

Set of linking parts for stabilizing adjoining elements as standard.

In bigger models, differences resulting from the hardness of polyurethane cold-moulded foam due to parameter variations within the range of +/-10% (as acceptable according to the DIN 53576/ISO 2439 norm) can be noticeable.

For better set-stability, it is possible to join the screens with linking parts:

- 1CW - option of joining from the right, left or both sides of the screen.

- 2BW - option of joining from the right, left or both sides of the screen.

- 2LW - option of joining only from the right side of the screen.

- 2RW - option of joining only from the left side of the screen.

- 3BW - option of joining from the right, left or both sides of the screen.

- 3RW - option of joining only from the left side of the screen.

- 3LW - option of joining only from the right side of the screen.

Please indicate clearly on your order which joining option is required.

It's not possible to assemble the screen with the armchair/sofa without preparing it at the manufacture stage.

The seat and screen can be in different price groups.

# Profim SORRISO

Jarosław Szymański, Studio 1:1

- Three base options: cantilever, four-star base or flat base
- Möbelfakta certificate - a guarantee of durability, safety, environmental care and social responsibility during the production process

Item no	Base model +	Price Group (PG)	Price Group						Price
			0	①	②	③	④	⑤	
MSY100V000	Profim SORRISO 10V • armchair • wire frame • frame: black		3 628	4 015	4 734	4 923	6 420	5 856	7 744

### Accessories/Options/Surcharges:

7SHQU006	Quilting - front side of the seat (Q5)	333
7CFRA051	Frame: MetallicPro	24

**0 price group: Evo**

**1 price group: Cura, Tonal, Xtreme**

**2 price group: Select**

**3 price group: Capture, Oceanic, Step, Synergy**

**4 price group: Steelcut 3, Steelcut Trio 3**

**6 price group: Paloma**

Castors / glides

Standard:

- teflon glides - universal

Option:

- felt glides - for hard floors

When ordering please clearly indicate the chosen option.

Option of mixing colours of the same fabric on shell and cushion according to below scheme:

A - cushion colour, B - shell colour.





In case of order of such option, following example should be specified: SC-67097/SC-60132 (where SC-67097 - A, SC-60132 - B). Option is available at no extra charge.

Quilting - extra charge to all price groups, lead time 30-40 working days.



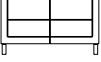
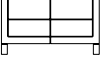

# Profim VANCOUVER LITE

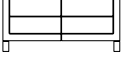
- Armchairs and sofas (in three sizes) come on metal cantilever and metal or wooden legs
- Complementary elements include a TV mount and media ports
- The collection is complemented by a simple wall which is used to connect the set in the shape of the letter "U"

Item no	Base model +	Price Group (PG)	Price Group						Price
			0	①	②	③	④	⑤	
MVT100H000	Profim VANCOUVER LITE VL1 H • armchair • legs • frame: black / MetallicPro / wooden legs		4 424	4 608	5 070	5 300	5 531	6 453	6 913
MVT100V000	Profim VANCOUVER LITE VL1 V • armchair • cantilevers • frame: black / MetallicPro		4 805	5 005	5 503	5 754	6 004	7 005	7 507
MVT200H000	Profim VANCOUVER LITE VL2 H • 2-seat sofa • legs • frame: black / MetallicPro / wooden legs		5 511	5 740	6 314	6 601	6 889	8 038	8 609
MVT200V000	Profim VANCOUVER LITE VL2 V • 2-seat sofa • cantilevers • frame: black / MetallicPro		5 890	6 135	6 751	7 058	7 363	8 590	9 204
MVT250H000	Profim VANCOUVER LITE VL2,5H • 2,5-seat sofa • legs • frame: black / MetallicPro / wooden legs		6 204	6 462	7 110	7 431	7 755	9 048	9 694
MVT250V000	Profim VANCOUVER LITE VL2,5V • 2,5-seat sofa • cantilevers • frame: black / MetallicPro		6 585	6 859	7 544	7 888	8 230	9 602	10 288

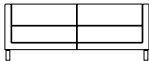
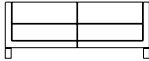

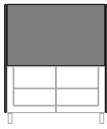
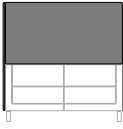
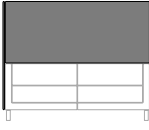
Item no	Base model +	Price Group (PG)	Price Group						Price
			0	①	②	③	④	⑤	
MVT300H000	Profim VANCOUVER LITE VL3 H • 3-seat sofa • legs • frame: black / MetallicPro / wooden legs		7 710	8 031	8 832	9 237	9 638	11 243	12 047
MVT300V000	Profim VANCOUVER LITE VL3 V • 3-seat sofa • cantilevers • frame: black / MetallicPro		8 090	8 426	9 270	9 692	10 112	11 798	12 641
MVTSW00000	Profim VANCOUVER LITE VL SW • straight connecting wall		1 584	1 650	1 815	1 897	1 980	2 309	
MVTW100000	Profim VANCOUVER LITE VL W1 • set of partition walls to be connected with armchair		5 130	5 345	5 879	6 146	6 413	7 483	
MVTW200000	Profim VANCOUVER LITE VL W2 • set of partition walls to be connected with 2-seater sofa		5 825	6 068	6 675	6 977	7 281	8 494	
MVTW250000	Profim VANCOUVER LITE VL W2,5 • set of partition walls to be connected with 2,5-seater sofa		6 637	6 913	7 604	7 950	8 296	9 678	
MVTW300000	Profim VANCOUVER LITE VL W3 • set of partition walls to be connected with 3-seater sofa		8 274	8 619	9 479	9 911	10 342	12 065	

**Accessories/Options/Surcharges:**

7TFRA013	Connecting with walls (HW/VW) (Only for: VL1 H, VL1 V)	294
7TFRA013	Connecting with walls (HW/VW) (Only for: VL2 H, VL2 V)	511
7TFRA013	Connecting with walls (HW/VW) (Only for: VL2,5H, VL2,5V, VL3 H, VL3 V)	673
7QUEL004	Quilting - inner surface (Q6) (Only for: VL SW)	1732
7QUEL004	Quilting - inner surface (Q6) (Only for: VL W1)	1996
7QUEL004	Quilting - inner surface (Q6) (Only for: VL W2)	2761
7QUEL004	Quilting - inner surface (Q6) (Only for: VL W2,5)	3140
7QUEL004	Quilting - inner surface (Q6) (Only for: VL W3)	7063
7QUEL006	Quilting - outer surface (Q7) (Only for: VL1 H, VL1 V)	835
7QUEL006	Quilting - outer surface (Q7) (Only for: VL2 H, VL2 V)	1091
7QUEL006	Quilting - outer surface (Q7) (Only for: VL2,5H, VL2,5V)	1214
7QUEL006	Quilting - outer surface (Q7) (Only for: VL3 H, VL3 V)	1539
7QUEL006	Quilting - outer surface (Q7) (Only for: VL SW)	2050
7QUEL006	Quilting - outer surface (Q7) (Only for: VL W1)	2444
7QUEL006	Quilting - outer surface (Q7) (Only for: VL W2)	3350
7QUEL006	Quilting - outer surface (Q7) (Only for: VL W2,5)	3713
7QUEL006	Quilting - outer surface (Q7) (Only for: VL W3)	8602
7TFRA016	TV handle (SW HA) (Only for: VL SW)	1377
7ELEC004	Mediaport - electrical outlet 230V and USB-C (Only for: VL1 H, VL1 V, VL2 H, VL2 V, VL2,5H, VL2,5V, VL3 H, VL3 V)	1810

**0 price group: Evo**

**1 price group: Cura, Tonal, Xtreme**

**2 price group: Select**

**3 price group: Capture, Oceanic, Step, Synergy**

**4 price group: Steelcut 3, Steelcut Trio 3**

**6 price group: Paloma**

Glides

Standard:

- hard glides - for soft floors (models H)

- felt pads - for hard floors (models V)

Option:

- felt glides - for hard floors (models H)

When ordering please clearly indicate the chosen option.

Wooden legs: beech wood - H5, H6, H12.

In VL W1, VL W2, VL W2,5, VL W3 option of mixing colours of the same fabric on inner and outer part of the partition wall according to below scheme:

A - inner part of shell, B - outer part of shell.

In case of order of such option, following example should be specified: SC-67097/SC-60132 (gdzie SC-67097 - A, SC-60132 - B). Option is available at no extra charge.

While ordering set of "U-shape" armchairs/sofas (including wall VL SW) please indicate clearly this option on your order. Distance between the seats in "U-shape set" - 940 mm.

Quilting - extra charge to all price groups, lead time 30-40 working days.

SW HA - acceptable dimension of TV: max. diagonal of the screen - 40 inches, max. weight - 10 kg.



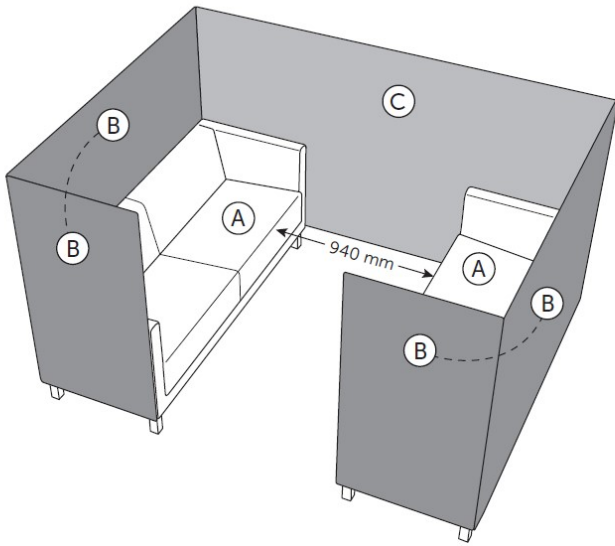

Sample of „U-shape” set with 3-seater sofas.

2 x A: VL 3 HW/VW  
(3-seat sofa, to be connected with partition walls)

2x B: VL W3  
(set of partition walls to be connected with 3-seater sofa)

1 x SW: VL SW  
(wall)

While ordering set of "U-shape" armchairs/sofas (including wall VL SW) please indicate clearly this option on your order.

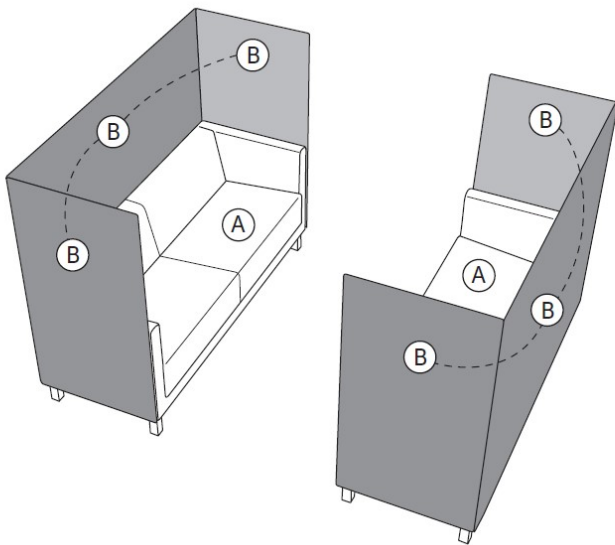









Sample of set with separate 3-seater sofas.

2 x A: VL 3 HW/VW  
(3-seat sofa, to be connected with partition walls)

2 x B: VL W3  
(set of partition walls to be connected with 3-seater sofa).

# Profim VANCOUVER OTO

- Available in two sizes and two shapes
- The set is also available as a pouffe + table in the version with an added glass top
- Possibility of connecting cubic pouffes by means of a linking element
- The mediaport is a complementary element

Item no	Base model +	Price Group (PG)	Price Group						Price
			0	①	②	③	④	⑤	
MVOR200000	Profim VANCOUVER OTO VOR2 • small round pouffe • ø 410 mm	 	1 284	1 338	1 471	1 536	1 604	1 870	2 004
MVOR100000	Profim VANCOUVER OTO VOR1 • large round pouffe • ø 540 mm	 	1 428	1 487	1 636	1 709	1 784	2 081	2 228
MVOS200000	Profim VANCOUVER OTO VOS2 • small square pouffe • 410 x 410 mm	 	1 336	1 392	1 530	1 599	1 669	1 947	2 087
MVOS100000	Profim VANCOUVER OTO VOS1 • large square pouffe • 540 x 540 mm	 	1 623	1 691	1 860	1 945	2 030	2 367	2 536

## Accessories/Options/Surcharges:

7TATO002	Table top milky tempered glass (Only for: VOR1, VOR2)	642
7TATO002	Table top milky tempered glass (Only for: VOS1, VOS2)	750
7ELEC004	Mediaport - electrical outlet 230V and USB-C (Only for: VOS1, VOS2)	1 810
7QUEL006	Quilting - outer surface (Q7)	703

**0 price group: Evo**

**1 price group: Cura, Tonal, Xtreme**

**2 price group: Select**

**3 price group: Capture, Oceanic, Step, Synergy**

**4 price group: Steelcut 3, Steelcut Trio 3**

**6 price group: Paloma**

Glides

Standard:

- hard glides - for soft floors.

Option:

- felt glides - for hard floors.

When ordering please clearly indicate the chosen option.

Table top G1 - lead time 20-30 working days.

Quilting - extra charge to all price groups, lead time 30-40 working days.







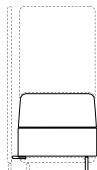
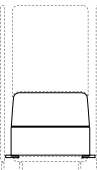

# Profim WALL IN

Tomek Rygalik, Studio Rygalik

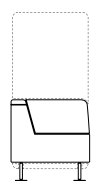
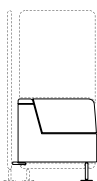

- Walls enabling the division of the interior and the introduction of distance
- Possibility to choose upholstery colour
- Legs finished with aesthetic plates, available in three colours
- The mediaport is a complementary element

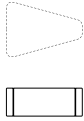
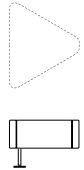
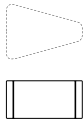
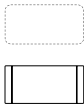
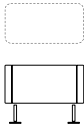
Item no	Base model +	Price Group (PG)	Price Group						Price
			0	①	②	③	④	⑤	
MWA1000000	Profim WALL IN 10 • pouffe • frame: black / MetallicPro		3 102	3 232	3 555	3 716	3 879	4 525	4 848
MWA1100000	Profim WALL IN 11 • pouffe to be connected with 1 partition wall • frame: black / MetallicPro		3 102	3 232	3 555	3 716	3 879	4 525	4 848
MWA1200000	Profim WALL IN 12 • pouffe to be connected with 2 partition walls • frame: black / MetallicPro		3 207	3 341	3 674	3 842	4 008	4 676	5 010
MWA1300000	Profim WALL IN 13 • pouffe to be connected with 3 partition walls • frame: black / MetallicPro		3 207	3 341	3 674	3 842	4 008	4 676	5 010
MWA2000000	Profim WALL IN 20 • armchair • frame: black / MetallicPro		4 058	4 227	4 648	4 860	5 072	5 916	6 341
MWA2100000	Profim WALL IN 21 • armchair to be connected with 1 partition wall • frame: black / MetallicPro		4 058	4 227	4 648	4 860	5 072	5 916	6 341

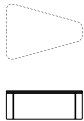
Item no	Base model +	Price Group (PG)	Price Group						Price
			0	①	②	③	④	⑤	
MWA2200000	Profim WALL IN 22 • armchair to be connected with 2 partition walls • frame: black / MetallicPro		4 162	4 335	4 769	4 986	5 203	6 071	6 503
MWA2300000	Profim WALL IN 23 • armchair to be connected with 3 partition walls • frame: black / MetallicPro		4 162	4 335	4 769	4 986	5 203	6 071	6 503
MWA3000000	Profim WALL IN 30 • corner armchair • frame: black / MetallicPro		4 633	4 826	5 310	5 552	5 793	6 757	7 240
MWA3100000	Profim WALL IN 31 • corner armchair to be connected with 1 partition wall • frame: black / MetallicPro		4 633	4 826	5 310	5 552	5 793	6 757	7 240
MWA3200000	Profim WALL IN 32 • corner armchair to be connected with 2 partition walls • frame: black / MetallicPro		4 738	4 936	5 428	5 675	5 924	6 910	7 404
MWAW110000	Profim WALL IN W11 • single partition wall to be connected with 1 seat • frame: black / MetallicPro		2 067	2 154	2 370	2 476	2 584	3 017	4 576
MWAW120000	Profim WALL IN W12 • single partition wall to be connected with 2 seats • frame: black / MetallicPro		2 067	2 154	2 370	2 476	2 584	3 017	4 576

Item no	Base model +	Price Group (PG)	Price Group						Price
			0	①	②	③	④	⑤	
MWAC100000	Profim WALL IN C1 • pouffe • 30°connector		1897	1977	2175	2274	2372	2768	2965
MWAC200000	Profim WALL IN C2 • pouffe • 60°connector • frame: black / MetallicPro		2447	2549	2804	2932	3060	3569	3825
MWAP100000	Profim WALL IN P1 • pouffe • 30° armrest		2041	2127	2340	2445	2551	2978	3190
MWAP300000	Profim WALL IN P3 • pouffe • rectangular armrest		1846	1923	2114	2212	2306	2691	2885
MWAP400000	Profim WALL IN P4 • pouffe • rectangular armrest on legs • frame: black / MetallicPro		2462	2565	2819	2948	3077	3590	3844
MWAB000000	Profim WALL IN B • square table • frame: black / MetallicPro		3666	3818	4199	4390	4581	5345	5728
MWAB100000	Profim WALL IN B1 • table • 30°connector		4832	5033	5533	5787	6039	7043	7548

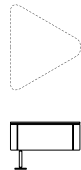

Item no	Base model +	Price Group (PG)	Price Group						Price
			0	①	②	③	④	⑤	
MWAB200000	Profim WALL IN B2 • table • 60°connector • frame: black / MetallicPro		3 770	3 926	4 320	4 517	4 712	5 497	5 891
MWABW10000	Profim WALL IN BW1 • square table to be connected with 1 partition wall • frame: black / MetallicPro		4 832	5 033	5 533	5 787	6 039	7 043	7 548
MWABW20000	Profim WALL IN BW2 • square table to be connected with 2 partition walls • frame: black / MetallicPro		3 666	3 818	4 199	4 390	4 581	5 345	5 728

#### Accessories/Options/Surcharges:

	Table top HPL (Only for: B, BW1, BW2)	1 307
	Table top HPL (Only for: B1)	1 091
	Table top HPL (Only for: B2)	1 523
7JIRO001	Possibility of joining in rows	31
7ELEC004	Mediaport - electrical outlet 230V and USB-C (Only for: 10, 11, 12, 13, 20, 21, 22, 23, 30, 31, 32)	1 841
7QUEL004	Quilting - inner surface (Q6) (Only for: 10, 11, 12, 13, C2)	379
7QUEL004	Quilting - inner surface (Q6) (Only for: 20, 21, 22, 23)	465
7QUEL004	Quilting - inner surface (Q6) (Only for: 30, 31, 32)	518
7QUEL004	Quilting - inner surface (Q6) (Only for: C1, P1, P3, P4)	271

**1 price group: Cura, Tonal, Xtreme**

**2 price group: Select**

**3 price group: Capture, Oceanic, Step, Synergy**

**4 price group: Steelcut 3, Steelcut Trio 3**

**6 price group: Paloma**

Glides

Standard:

- metal glides - for soft floors.

Option:

- felt glides - for hard floors.

When ordering please clearly indicate the chosen option.

Model P4 (on legs) allows the completion of any system.

Glides and linking parts for partition walls are provided with the seat to be connected with the partition wall.

Wall In W11/W12 models never occur as freestanding elements.

Table top G1 - lead time 20-30 working days.

Colours of HPL (LW): White (LW01), Light Grey (LW03); Grey (LW04), Black (LW02), Navy Blue (LW06), Light Burgundy (LW07) - lead time 20-30 working days.

Quilting - extra charge to all price groups, lead time 30-40 working days.



Tables







Coat stands







Accessories







# Profim ALLROUND

- Table top in Laminate and Linoleum (24 mm) or Melamine Beech (22 mm)
- Table edge band will match table top colour as standard. Optionally choose black, white or grey table edge band to any table top colour within our rangewithout extra charge.

Item no	Base model +	Price Group (PG)	①	②	③	Price
5180-30	Profim ALLROUND 5180-30 (E) <ul style="list-style-type: none"> <li>• Tables, height 73/90 cm</li> <li>• 80 x 80 cm with column frame base with 4 star footbase</li> </ul>		2 750	3 727	4 844	
5180-10	Profim ALLROUND 5180-10 (E) <ul style="list-style-type: none"> <li>• Table, height 73/90 cm</li> <li>• 180 x 90 cm with T frame</li> <li>• Distance between legs 110 cm</li> </ul>		4 088	6 219	8 084	
5180-22	Profim ALLROUND 5180-22 (S) <ul style="list-style-type: none"> <li>• Table, height 73/90 cm</li> <li>• 180 x 80 cm with T frame</li> <li>• Distance between table legs 110 cm</li> </ul>		3 988	5 906	7 678	
5180-24	Profim ALLROUND 5180-24 (E) <ul style="list-style-type: none"> <li>• Table, height 73/90 cm</li> <li>• 160 x 80 cm with T frame</li> <li>• Distance between table legs 110 cm</li> </ul>		3 881	5 617	7 301	
5180-25	Profim ALLROUND 5180-25 (S) <ul style="list-style-type: none"> <li>• Table, height 73/90 cm</li> <li>• 140 x 80 cm with T frame</li> <li>• Distance between table legs 80 cm</li> <li>• Weight approx. 24.5 kg Lam.</li> </ul>		3 779	5 536	7 198	
5180-27	Profim ALLROUND 5180-27 (S) <ul style="list-style-type: none"> <li>• Table, height 73/90 cm</li> <li>• 120 x 80 cm with T frame</li> <li>• Distance between table legs 80 cm</li> </ul>		3 704	5 358	6 966	

Item no	Base model +	Price Group (PG)	①	②	③	Price
5180-36	Profim ALLROUND 5180-36 (E) <ul style="list-style-type: none"> <li>• Table, height 73/90 cm</li> <li>• 180 x 70 cm with T frame</li> <li>• Distance between table legs 110 cm</li> </ul>		3881	5596	7275	
5180-38	Profim ALLROUND 5180-38 (S) <ul style="list-style-type: none"> <li>• Table, height 73/90 cm</li> <li>• 140 x 70 cm with T frame</li> <li>• Distance between table legs 80 cm</li> </ul>		3727	5411	7035	
5180-39	Profim ALLROUND 5180-39 (S) <ul style="list-style-type: none"> <li>• Table, height 73/90 cm</li> <li>• 120 x 70 cm with T frame</li> <li>• Distance between table legs 80 cm</li> </ul>		3626	5112	6646	
5182-10	Profim ALLROUND 5182-10 (E) <ul style="list-style-type: none"> <li>• Round table with frame base, height 50/73 cm</li> <li>• Ø60 cm - 4 star footbase</li> </ul>		2791	3882	5047	
5182-102	Profim ALLROUND 5182-102 (E) <ul style="list-style-type: none"> <li>• High table, height 90/110 cm</li> <li>• Ø60 cm - 4 star footbase</li> </ul>		2934	4025	5233	
5182-15	Profim ALLROUND 5182-15 (S) <ul style="list-style-type: none"> <li>• Round table with frame base, height 50/73 cm</li> <li>• Ø70 cm - 4 star footbase</li> </ul>		2886	4080	5303	
5182-152	Profim ALLROUND 5182-152 (E) <ul style="list-style-type: none"> <li>• High table, height 90/110 cm</li> <li>• Ø70 cm - 4 star footbase</li> </ul>		3027	4224	5492	

Item no	Base model +	Price Group (PG)	①	②	③	Price
5182-20	Profim ALLROUND 5182-20 (E) • Round table with frame base, height 50/73 cm • Ø80 cm - 4 star footbase		3 065	4 324	5 621	
5182-202	Profim ALLROUND 5182-202 (E) • High table, height 90/110 cm • Ø80 cm - 4 star footbase		3 207	4 465	5 805	
5182-25	Profim ALLROUND 5182-25 (E) • Round table with frame base, height 50/73 cm • Ø100 cm - 5 star footbase		3 516	5 045	6 558	
5182-30	Profim ALLROUND 5182-30 (E) • Round table with frame base, height 50/73 cm • Ø120 cm - 5 star footbase		3 795	5 636	7 327	
5184-01	Profim ALLROUND 5184-01 (E) • Ellipse table • Height 73/90 cm • 180 x 100 cm with T frame, seats 6 • Distance between table legs 110 cm		5 163	7 056	9 172	

#### Accessories/Options/Surcharges:

RS091003	Linking device with screws, not mounted, see below. Available for rectangular table w/ straight edged table top	129
----------	---	-----

#### 1. Melamine on chipboard (only beech)

#### 2. Laminate on chipboard

#### 3. Linoleum on chipboard

Height: 50/73/90/110 cm

Profim Allround table tops (rectangular and squared shapes) can be made available with MDF table core, chamfered edges of 20 degr and with a 10 mm black, white or grey edge band and black paint

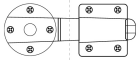

RS091003

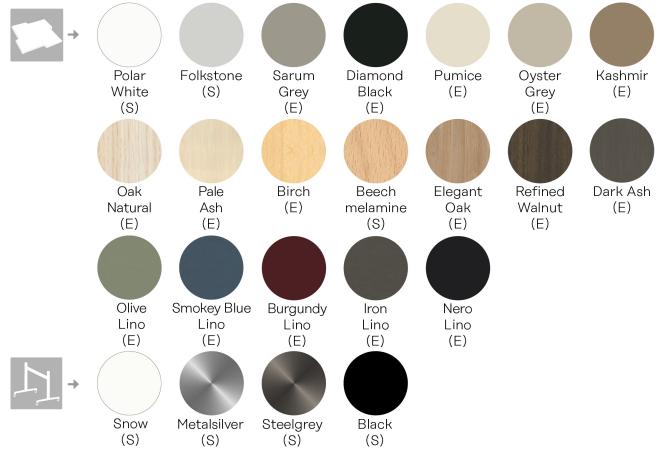

S=Standard Collection - normal production time 20-30 working days. Applicable when table top and base are standard (S).

E=Extended Collection - normal production time 30-35 working days (Linoleum: 35 working days). Applicable when any or all component options selected are extended (E).

For larger orders, please contact Customer Service for delivery details.







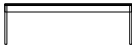

# Profim CHIC COFFEE TABLE

Christophe Pillet

- A wide range of options for the tabletop finish: glass and wooden
- Possibility to use transparent glides in coffee tables

Item no	Base model +	Price Group (PG)	①	②	③	Price
MPHCS30000	Profim CHIC TABLE CS30 <ul style="list-style-type: none"> <li>• coffee table</li> <li>• square</li> <li>• high</li> <li>• 450 x 450 x 560 mm</li> <li>• Frames colours: MetallicPro; Black RAL 9005; White RAL 9016; Deep Green RAL 6004; Navy Blue RAL 5003; Burgundy RAL 3005; Salvia/Green RAL 6021, Blue RAL 5014; Terracota RAL 3012</li> </ul>		2 591	2 427	2 591	
MPHCS40000	Profim CHIC TABLE CS40 <ul style="list-style-type: none"> <li>• coffee table</li> <li>• square</li> <li>• low</li> <li>• 800 x 800 x 250 mm</li> <li>• Frames colours: MetallicPro; Black RAL 9005; White RAL 9016; Deep Green RAL 6004; Navy Blue RAL 5003; Burgundy RAL 3005; Salvia/Green RAL 6021, Blue RAL 5014; Terracota RAL 3012</li> </ul>		3 777	3 517	3 777	
MPHCR40000	Profim CHIC TABLE CR40 <ul style="list-style-type: none"> <li>• coffee table</li> <li>• round</li> <li>• low</li> <li>• Ø 800 mm</li> <li>• Frames colours: MetallicPro; Black RAL 9005; White RAL 9016; Deep Green RAL 6004; Navy Blue RAL 5003; Burgundy RAL 3005; Salvia/Green RAL 6021, Blue RAL 5014; Terracota RAL 3012</li> </ul>		3 463	3 218	3 463	
MPHCS3000F	Profim CHIC TABLE FRAME CS30 <ul style="list-style-type: none"> <li>• table's frame</li> <li>• square</li> <li>• 450 x 450 x 560 mm</li> <li>• Frames colours: MetallicPro; Black RAL 9005; White RAL 9016; Deep Green RAL 6004; Navy Blue RAL 5003; Burgundy RAL 3005; Salvia/Green RAL 6021, Blue RAL 5014; Terracota RAL 3012</li> </ul>					1 460
MPHCS4000F	Profim CHIC TABLE FRAME CS40 <ul style="list-style-type: none"> <li>• table's frame</li> <li>• square</li> <li>• 800 x 800 x 250 mm</li> <li>• Frames colours: MetallicPro; Black RAL 9005; White RAL 9016; Deep Green RAL 6004; Navy Blue RAL 5003; Burgundy RAL 3005; Salvia/Green RAL 6021, Blue RAL 5014; Terracota RAL 3012</li> </ul>					1 759

Item no	Base model +	Price Group (PG)	①	②	③	Price
MPHCR4000F	Profim CHIC TABLE FRAME CR40 • table's frame • Ø 800 mm • height 250 mm • Frames colours: MetallicPro; Black RAL 9005; White RAL 9016; Deep Green RAL 6004; Navy Blue RAL 5003; Burgundy RAL 3005; Salvia/Green RAL 6021, Blue RAL 5014; Terracota RAL 3012					1 486

#### Accessories/Options/Surcharges:

7COPR003	Frames colours: Lightgrey NCS S 2500-N; Grey NCS S 6500-N					141
7COPR006	Frame colour: Gold					487

1. Veneers
2. Tempered glass (G1)
3. Tempered glass (G2/ G3/ G4)

**Metal: MetallicPro; Black RAL 9005; White RAL 9016; Deep Green RAL 6004; Navy Blue RAL 5003; Burgundy RAL 3005; Salvia/Green RAL 6021, Blue RAL 5014; Terracota RAL 3012**

**Tempered glass: G1 (milky)**

**Tempered glass: G2 (black), G3 (RAL 7044/taupe), G4 (RAL 7042/grey)**

**Natural veneers: Ash (NA), Beech (NB), Oak (NO), Walnut (NW)**

**Natural colored veneers (ash): White (CNA01), Black (CNA02), Dark green (CNA05), Navy blue (CNA06), Burgundy (CNA07)**

Glides: transparent, universal.

Option of mixing colours table top and frames.

Glass table top - lead time 20-30 working days.

Colours of natural modified veneers (HM): HM10 (bleached oak), HM11 (classic oak), HM12 (cardinal oak), HM20 (venge classic) - lead time 20-30 working days.

Frame is dedicated for assembly table tops made only from chipboard, plywood or wood. Self-assembly is not possible in case of glass and ceramics table tops.

Maximum parameters of the table top:

CR40 - Ø 800 mm, weight 14 kg,



CS40 - 800 x 800 mm, weight 18 kg,



CS30 - 450 x 450 mm, weight 11 kg.

# Profim CHIC RESTAURANT TABLE

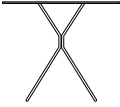
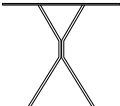
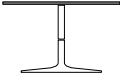
Christophe Pillet

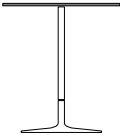
- A wide range of options for the tabletop finish: glass, wooden
- Several heights and types of bases offer many arrangement variants

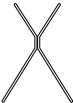
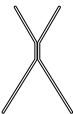
Item no	Base model +	Price Group (PG)	①	②	③	Price
MPHRH30000	Profim CHIC RESTAURANT TABLE RH30 <ul style="list-style-type: none"> <li>• medium table</li> <li>• round Ø 800 mm</li> <li>• height 660 mm</li> <li>• 4-legged</li> <li>• frame: MetallicPro; Black RAL 9005; White RAL 9016; Deep Green RAL 6004; Navy Blue RAL 5003; Burgundy RAL 3005; Salvia/Green RAL 6021, Blue RAL 5014; Terracota RAL 3012</li> </ul>		4 186	3 219	3 407	
MPHRH20000	Profim CHIC RESTAURANT TABLE RH20 <ul style="list-style-type: none"> <li>• medium table</li> <li>• round Ø 800 mm</li> <li>• height 740 mm</li> <li>• 4-legged</li> <li>• frame: MetallicPro; Black RAL 9005; White RAL 9016; Deep Green RAL 6004; Navy Blue RAL 5003; Burgundy RAL 3005; Salvia/Green RAL 6021, Blue RAL 5014; Terracota RAL 3012</li> </ul>		4 186	3 219	3 407	
MPHRR40000	Profim CHIC RESTAURANT TABLE RR40 <ul style="list-style-type: none"> <li>• restaurant table</li> <li>• round Ø 800 mm</li> <li>• height 480 mm</li> <li>• round base</li> <li>• frame: MetallicPro; Black RAL 9005; White RAL 9016; Deep Green RAL 6004; Navy Blue RAL 5003; Burgundy RAL 3005; Salvia/Green RAL 6021, Blue RAL 5014; Terracota RAL 3012</li> </ul>		4 826			
MPHRR20000	Profim CHIC RESTAURANT TABLE RR20 <ul style="list-style-type: none"> <li>• restaurant table</li> <li>• round Ø 800 mm</li> <li>• height 740 mm</li> <li>• round base</li> <li>• frame: MetallicPro; Black RAL 9005; White RAL 9016; Deep Green RAL 6004; Navy Blue RAL 5003; Burgundy RAL 3005; Salvia/Green RAL 6021, Blue RAL 5014; Terracota RAL 3012</li> </ul>		4 909			
MPHRR10000	Profim CHIC RESTAURANT TABLE RR10 <ul style="list-style-type: none"> <li>• restaurant table</li> <li>• round Ø 800 mm</li> <li>• height 1100 mm</li> <li>• round base</li> <li>• frame: MetallicPro; Black RAL 9005; White RAL 9016; Deep Green RAL 6004; Navy Blue RAL 5003; Burgundy RAL 3005; Salvia/Green RAL 6021, Blue RAL 5014; Terracota RAL 3012</li> </ul>		4 950			

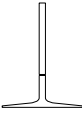
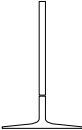
Item no	Base model +	Price Group (PG)	①	②	③	Price
MPHRH3000F	Profim CHIC RESTAURANT TABLE RH30 FRAME <ul style="list-style-type: none"> <li>table's frame</li> <li>height 660 mm</li> <li>frame: MetallicPro; Black RAL 9005; White RAL 9016; Deep Green RAL 6004; Navy Blue RAL 5003; Burgundy RAL 3005; Salvia/Green RAL 6021, Blue RAL 5014; Terracota RAL 3012</li> </ul>					1553
MPHRH2000F	Profim CHIC RESTAURANT TABLE RH20 FRAME <ul style="list-style-type: none"> <li>table's frame</li> <li>height 740 mm</li> <li>frame: MetallicPro; Black RAL 9005; White RAL 9016; Deep Green RAL 6004; Navy Blue RAL 5003; Burgundy RAL 3005; Salvia/Green RAL 6021, Blue RAL 5014; Terracota RAL 3012</li> </ul>					1553
MPHRR4000F	Profim CHIC RESTAURANT TABLE RR40 FRAME <ul style="list-style-type: none"> <li>table's frame</li> <li>height 480 mm</li> <li>round base</li> <li>frame: MetallicPro; Black RAL 9005; White RAL 9016; Deep Green RAL 6004; Navy Blue RAL 5003; Burgundy RAL 3005; Salvia/Green RAL 6021, Blue RAL 5014; Terracota RAL 3012</li> </ul>					2182
MPHRR2000F	Profim CHIC RESTAURANT TABLE RR20 FRAME <ul style="list-style-type: none"> <li>table's frame</li> <li>height 740 mm</li> <li>round base</li> <li>frame: MetallicPro; Black RAL 9005; White RAL 9016; Deep Green RAL 6004; Navy Blue RAL 5003; Burgundy RAL 3005; Salvia/Green RAL 6021, Blue RAL 5014; Terracota RAL 3012</li> </ul>					2250
MPHRR1000F	Profim CHIC RESTAURANT TABLE RR10 FRAME <ul style="list-style-type: none"> <li>table's frame</li> <li>height 1100 mm</li> <li>round base</li> <li>frame: MetallicPro; Black RAL 9005; White RAL 9016; Deep Green RAL 6004; Navy Blue RAL 5003; Burgundy RAL 3005; Salvia/Green RAL 6021, Blue RAL 5014; Terracota RAL 3012</li> </ul>					2319
<b>Accessories/Options/Surcharges:</b>						
7COPR003	Frames colours: Lightgrey NCS S 2500-N; Grey NCS S 6500-N					141
7COPR006	Frame colour: Gold (Only for: RH20, RH20 FRAME, RH30, RH30 FRAME)					487
7COPR006	Frame colour: Gold (Only for: RR10, RR10 FRAME, RR20, RR20 FRAME, RR40, RR40 FRAME)					473

**1. Natural veneers: Ash (NA), Beech (NB), Oak (NO), Walnut (NW)**

Natural colored veneers (ash): White (CNA01), Black (CNA02), Dark green (CNA05), Navy blue (CNA06), Burgundy (CNA07)

**2. Tempered glass: G1 (milky)**

**3. Tempered glass: G2 (black), G3 (RAL 7044/taupe), G4 (RAL 7042/grey)**

Glides: teflon glides - universal.

Option of mixing colours table top and frames.

Glass table top - lead time 20-30 working days.

Iron cast base in Tables RR always black.

Natural veneers - lead time 20-30 working days.

Frame in Tables RR is dedicated for assembly table tops made only from chipboard, plywood or wood. Self-assembly is not possible in case of glass and ceramics table tops.





Maximum parameters of the table top:







RH - Ø 800 mm, weight 7 kg,

RR - Ø 800 mm, weight 24 kg.

# Profim EMINENT

- Ø38 mm tubular table leg in various colours. See below Accessories/options. Incl. levelling feet (up to 17 mm on all legs)
- Table tops in various colours, see below Accessories/options.
- Table edge band will match table top colour as standard. Optionally choose black, white or grey table edge band to any table top colour within our range without extra charge.
- Table suspension brackets for several tables available for Profim Ana and Noor (except 6080/85). Cannot be attached to round tables

Item no	Base model +	Price Group (PG)	①	②	③	Price
4590-22	Profim EMINENT 4590-22 (S) <ul style="list-style-type: none"> <li>• 180 x 80 cm</li> <li>• Distance between the table legs 164 cm</li> <li>• Weight appr 33.2 kg Lam.</li> </ul>		3 949	4 874	6 336	
4590-24	Profim EMINENT 4590-24 (S) <ul style="list-style-type: none"> <li>• 160 x 80 cm</li> <li>• Distance between the table legs 144 cm</li> <li>• Weight appr 29.8 kg Lam.</li> </ul>		3 748	4 504	5 856	
4590-25	Profim EMINENT 4590-25 (S) <ul style="list-style-type: none"> <li>• 140 x 80 cm</li> <li>• Distance between the table legs 124 cm</li> <li>• Weight appr 27.3 kg Lam.</li> </ul>		3 496	4 191	5 449	
4590-27	Profim EMINENT 4590-27 (S) <ul style="list-style-type: none"> <li>• 120 x 80 cm</li> <li>• Distance between the table legs 104 cm</li> <li>• Weight appr 24.2 kg Lam.</li> </ul>		3 293	3 992	5 190	
4590-30	Profim EMINENT 4590-30 (E) <ul style="list-style-type: none"> <li>• 80 x 80 cm</li> <li>• Distance between the table legs 64 cm</li> <li>• Weight appr 18.7 kg Lam.</li> </ul>		2 835	3 463	4 502	

Item no	Base model +	Price Group (PG)	①	②	③	Price
4590-38	Profim EMINENT 4590-38 (S) <ul style="list-style-type: none"> <li>• 140 x 70 cm</li> <li>• Distance between the table legs 124 cm</li> <li>• Weight appr 25.2 kg Lam.</li> </ul>		3 435	4 118	5 354	
4590-52	Profim EMINENT 4590-52 (E) <ul style="list-style-type: none"> <li>• 140 x 60 cm</li> <li>• Distance between the table legs 124 cm</li> <li>• Weight appr 23 kg Lam.</li> </ul>		3 561	4 264	5 544	
4590-54	Profim EMINENT 4590-54 (S) <ul style="list-style-type: none"> <li>• 120 x 60 cm</li> <li>• Distance between the table legs 104 cm</li> <li>• Weight appr 20.4 kg Lam</li> </ul>		2 750	3 614	4 698	
4592-30	Profim EMINENT 4592-30 (E) <ul style="list-style-type: none"> <li>• Ø120 cm with 4 legs</li> <li>• Distance between the table legs 60 cm</li> </ul>		3 683	5 159	6 707	
4592-50	Profim EMINENT 4592-50 (E) <ul style="list-style-type: none"> <li>• Ø160 cm with 4 legs</li> <li>• Distance between the table legs 91 cm</li> </ul>		5 690			
4593-15	Profim EMINENT 4593-15 (E) <ul style="list-style-type: none"> <li>• Trapezium 140 x 70 x 70 x 70, depth 60 cm</li> <li>• Distance between the table legs 116/53/60 cm</li> </ul>		3 571	4 287	5 572	
<b>Accessories/Options/Surcharges:</b>						
M30410	Bracket for 1 chair. Noor**					331
M130355	Bracket for 2 chairs. Ana**					1 048
M130360	Bracket for 2 chairs. Ana (One chair per table side)**					1 048

**Accessories/Options/Surcharges:**

M09502

Castors Eminent 4 pcs. Lockable

1 307

**1. Melamine on chipboard (only beech)**

**2. Laminate on chipboard**

**3. Linoleum on chipboard**

Table top in Laminate and Linoleum (24 mm) or Melamine Beech (22 mm)

Height approx. 73.5 cm. Table leg adjustment screw on legs

\*\* See separate page "Table/chair suspension bracket system" for details

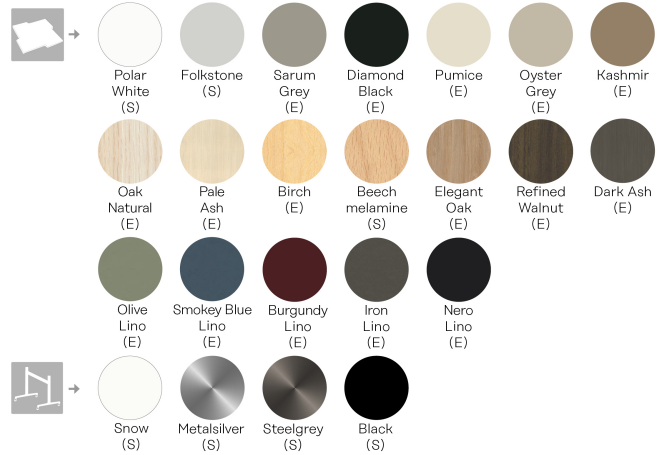

S=Standard Collection – normal production time 20-30 working days. Applicable when table top and base are standard (S).

E=Extended Collection – normal production time 30-35 working days (Linoleum: 35 working days). Applicable when any or all component options selected are extended (E).

For larger orders, please contact Customer Service for delivery details.



## Table/chair suspension bracket system for Eminent table

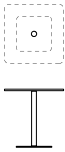
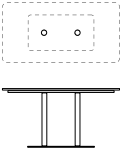
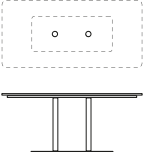

Table size (Length x width)	Width between legs (width chair)	Noor 6050/6055* (M30410 Bracket)	Noor 6060/6065* (M30410 Bracket)	Noor 6070/6075* (M30410 Bracket)	Ana	Com H/V (M30403 Bracket)
1200x600	1046x(446)	1	1	1	1 (M130350)	1 or 2
800x800	646x(646)	1 on both sides	1 on both sides	1 on both sides	2 on same side (M130355)	1 on both sides
1200x800	1046	1 on both sides	1 on both sides	1 or 2 on both sides	2 (1 on both sides) (M130360)	1 or 2 on both sides
1400x600	1246	1 or 2 on one side	1 or 2 on one side	1 or 2 on one side	4 (2 on both sides) (M130365)	1 or 2
1400x700	1246	1 or 2 on both sides	1 or 2 on both sides	1 or 2 on both sides	-	1 or 2 on both sides
1400x800	1246	1 or 2 on both sides	1 or 2 on both sides	1 or 2 on both sides	-	1 or 2 on both sides
1600x800	1446	1 or 2 on both sides	1 or 2 on both sides	1 or 2 on both sides	-	1 or 2 on both sides
1800x800	1646	1, 2 or 3 on both sides	1 or 2 on both sides	1 or 2 on both sides	6 (3 on both sides) (M130370)	1, 2 or 3 on both sides





\* Valid for unupholstered chair, upholstered Seat (S), upholstered Seat and Back (SB) and Fully upholstered (F) variants. Table suspension bracket not applicable for Noor 6080/6085

# Profim REVO TABLES

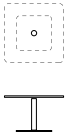
Pearson Lloyd

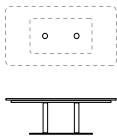
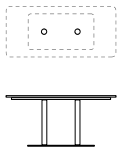
- tables and table frames of different length and height and shape
- designed with comfort in mind
- versatile and lightweight design
- various color palette of table tops and frames

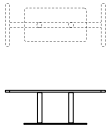
Item no	Base model +	Price Group (PG)	①	②	Price
MRVT750000	Profim REVO T75 • table 750 x 750 mm • height 740 mm • square, flat base		5 557	5 911	
MRVT150000	Profim REVO T150 • table 1500 x 750 mm • height 740 mm • rectangular, flat base		10 405	10 892	
MRVT180000	Profim REVO T180 • table 1800 x 850 mm • height 740 mm • rectangular, flat base		11 977	13 050	
MRVLS65000	Profim REVO LS65 • table 650 x 350 mm • height 665 mm • rectangular, flat base		3 731	3 963	
MRVLR48000	Profim REVO LR48 • table round Ø 480 mm • height 665 mm • round base, flat base		3 731	3 963	
MRVC750000	Profim REVO C75 • low table 750 x 750 mm • height 450 mm • square, flat base		5 380	5 745	

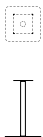
Item no	Base model +	Price Group (PG)	①	②	Price
MRVC150000	Profim REVO C150 • low table 1500 x 750 mm • height 450 mm • rectangular, flat base		10 051	10 528	
MRVT140000	Profim REVO MT140 • medium table 1400 x 700 mm • height 650 mm • rectangular, flat base		10 053	10 516	
MRVC75000F	Profim REVO FRAME C75 • table's frame • height 440 mm • square, flat base				3 461
MRVC15000F	Profim REVO FRAME C150 • table's frame • height 440 mm • rectangular, flat base				6 705
MRVLR4800F	Profim REVO FRAME LR48 • table's frame • height 655 mm • round base, flat base				2 833
MRVLS6500F	Profim REVO FRAME LS65 • table's frame • height 655 mm • rectangular, flat base				2 946
MRVT75000F	Profim REVO FRAME T75 • table's frame • height 730 mm • square, flat base				3 739

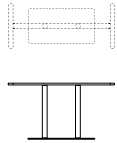
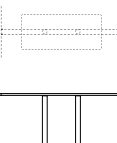
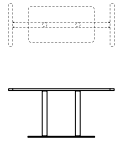
Item no	Base model +	Price Group (PG)	①	②	Price
MRVT15000F	Profim REVO FRAME T150 • table's frame • height 730 mm • rectangular, flat base				7 323
MRVT18000F	Profim REVO TABLES FRAME T180 • table's frame • height 730 mm • rectangular, flat base				8 312
MRVT14000F	Profim REVO FRAME MT140 • table's frame • height 640 mm • rectangular, flat base				7 138

## **1. Natural veneers / Natural colored veneers (ash)Frame**

### **2. HPL**

MetallicPro; Black RAL 9005; White RAL 9016; Light Grey NCS S 2500 N; Grey NCS S 6500 N; Deep Green RAL 6004; Navy Blue RAL 5003; Burgundy RAL 3005; Salvia/Green RAL 6021, Blue RAL 5014; Terracota RAL 3012

#### **Natural veneers**

Ash (NA), Beech (NB), Oak (NO), Walnut (NW)

#### **Natural colored veneers (ash)**

White (CNA01), Black (CNA02), Dark green (CNA05), Navy blue (CNA06), Burgundy (CNA07)

#### **HPL**

White (LW01), Light Grey (LW03); Grey (LW04), Black (LW02), Navy Blue (LW06), Light Burgundy (LW07)

There is a possibility of any combination of the top and frame colors.

Natural veneers: Ash (NA); Beech (NB); Oak (NO); Orzech (NW) - delivery time 30 business days.

Natural colored veneers: delivery time 30 business days.

HPL worktops: delivery time 30 business days.

Frame in Revo Tables is dedicated for assembly table tops made only from chipboard, plywood or wood.

Maximum parameters of the table top:

C75- 750 x 750 mm, weight 4kg.

C150 - 1500 x 750 mm, weight 8 kg.

LR48 - Ø 480 mm, weight 1,5 kg.

LS65 - 350 x 650 mm, weight 2kg

T75 - 750 x 750 mm, weight 4kg.

T150 - 1500 x 750 mm, weight 8 kg.

T180 - 1800 x 850 mm, weight 11kg.







MT140 - 1400 x 700 mm, weight 7kg.

# Profim STANDARD FOLDING TABLE

- Folding table - 100 mm height when collapsed (with 22 mm table top)
- Frame in various colours. See below Accessories/options.
- For table top colours, see below Accessories/options.
- Table top edge band will match table top as standard. Optionally choose black, white or grey table edge band to any table top colour within our range without extra charge.
- Table top in Laminate (24 mm) or Melamine Beech (22 mm)

Item no	Base model +	Price Group (PG)	①	②	Price
4680-10	Profim STANDARD FOLDING TABLE 4680-10 (E) <ul style="list-style-type: none"> <li>• 180 x 90 cm</li> <li>• Distance between the table legs 103 cm</li> <li>• Weight appr 30.9 kg Lam.</li> </ul>		3 562	4 926	
4680-15	Profim STANDARD FOLDING TABLE 4680-15 (S) <ul style="list-style-type: none"> <li>• 120 x 90 cm</li> <li>• Distance between the table legs 103 cm</li> <li>• Weight appr 22.6 kg Lam.</li> </ul>		3 079	3 989	
4680-22	Profim STANDARD FOLDING TABLE 4680-22 (S) <ul style="list-style-type: none"> <li>• 180 x 80 cm</li> <li>• Distance between the table legs 103 cm</li> <li>• Weight appr 28.1 kg Lam.</li> </ul>		3 095	4 546	
4680-24	Profim STANDARD FOLDING TABLE 4680-24 (S) <ul style="list-style-type: none"> <li>• 160 x 80 cm</li> <li>• Distance between the table legs 103 cm</li> <li>• Weight appr 25.7 kg Lam.</li> </ul>		3 002	4 278	
4680-25	Profim STANDARD FOLDING TABLE 4680-25 (S) <ul style="list-style-type: none"> <li>• 140 x 80 cm</li> <li>• Distance between the table legs 103 cm</li> <li>• Weight appr 23.2 kg Lam.</li> </ul>		2 891	3 997	

Item no	Base model +	Price Group (PG)	①	②	Price
4680-27	Profim STANDARD FOLDING TABLE 4680-27 (S) <ul style="list-style-type: none"> <li>• 120 x 80 cm</li> <li>• Distance between the table legs 103 cm</li> <li>• Weight appr 20.8 kg Lam.</li> </ul>		2581	3674	
4680-36	Profim STANDARD FOLDING TABLE 4680-36 (E) <ul style="list-style-type: none"> <li>• 180 x 70 cm</li> <li>• Distance between the table legs 103 cm</li> <li>• Weight appr 25.4 kg Lam.</li> </ul>		3002	4051	
4680-38	Profim STANDARD FOLDING TABLE 4680-38 (S) <ul style="list-style-type: none"> <li>• 140 x 70 cm</li> <li>• Distance between the table legs 103 cm</li> <li>• Weight appr 21.1 kg Lam.</li> </ul>		2614	3611	
4680-39	Profim STANDARD FOLDING TABLE 4680-39 (S) <ul style="list-style-type: none"> <li>• 120 x 70 cm</li> <li>• Distance between the table legs 103 cm</li> <li>• Weight appr 18.9 kg Lam.</li> </ul>		2583	3468	
4680-52	Profim STANDARD FOLDING TABLE 4680-52 (S) <ul style="list-style-type: none"> <li>• 140 x 60 cm</li> <li>• Distance between the table legs 103 cm</li> <li>• Weight appr 18.9 kg Lam.</li> </ul>		2770	3642	
4680-54	Profim STANDARD FOLDING TABLE 4680-54 (S) <ul style="list-style-type: none"> <li>• 120 x 60 cm</li> <li>• Distance between the table legs 103 cm</li> <li>• Weight appr 17.1 kg Lam.</li> </ul>		2384	3267	

Item no	Base model +	Price Group (PG)	①	②	Price
4680-58	Profim STANDARD FOLDING TABLE 4680-58 (S) • Exam table 90 x 60 cm • Distance between the table legs 75 cm • Weight appr 14.3 kg Lam.		2237	2770	
4680-90	Profim STANDARD FOLDING TABLE 4680-90 (S) • 120 x 45 cm • Distance between the table legs 103 cm • Weight appr 14.3 kg Lam.		2250	2891	
4681-45	Profim STANDARD FOLDING TABLE 4681-45 (E) • 1/2 circle with folding frame, Ø160 cm • Distance between the table legs 74 cm		3403	4819	
4688-52	Profim STANDARD FOLDING TABLE 4688-52 (E) • L-frame • 140 x 60 cm • Distance between the table legs 103 cm • Weight appr 18.9 kg Lam.		2770	3642	
4688-54	Profim STANDARD FOLDING TABLE 4688-54 (E) • L-frame • 120 x 60 cm • Distance between the table legs 103 cm • Weight appr 17.1 kg Lam.		2384	3282	
4688-90	Profim STANDARD FOLDING TABLE 4688-90 (E) • L-frame • 120 x 45 cm • Distance between the table legs 103 cm • Weight appr 14.3 kg Lam.		2250	2891	

**Accessories/Options/Surcharges:**

RS091003	Linking device with screws, not mounted, see below. Available for rectangular table w/ straight edged table top	129
RS092064	Standard Folding table levelling screw	11
3211	Trolley 125 x 71 cm, (without drive bar and retainer for trolley), transport tables (7) standing or (12) lying down	6847



**Accessories/Options/Surcharges:**

3212	Trolley 200x71 cm (without drive bar and retainer for trolley), transport tables 13 Std. standing or 12 lying down	7 785
3213	Drive bar for trolley	3 057
3214	Retainer for trolley - requires 2 per trolley for transport of standing tables - price per unit	4 086

**1. Melamine on chipboard (only beech)**

**2. Laminate on chipboard**

Height, approx: 74.5 cm

Trolley with frame. 3211 for transport of 5 upright Profm Standard folding tables. 3212 for transport of 13 upright Profim Standard folding tables. Both trolleys can hold 12 tables lying down

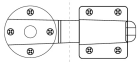

RS091003

S=Standard Collection – normal production time 20-30 working days. Applicable when table top and base are standard (S).

E=Extended Collection – normal production time 30-35 working days. Applicable when any or all component options selected are extended (E).

For larger orders, please contact Customer Service for delivery details.



Lightweight core on request.

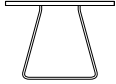
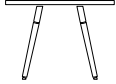
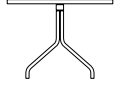
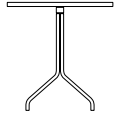
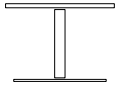
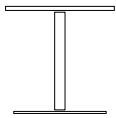

# Profim TABLES

- SR model comes in four heights, in three colour variations of the base on a circular form
- SH model comes in three heights, four frame colours and a round top made of tempered milk glass
- SF model comes in two heights on a four-star polished aluminium base
- SV model is available on a metal wire frame with four colour variations and the SW model on wooden legs

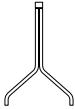
Item no	Base model +	Price Group (PG)	Tempered glass (G1)	Price
MQC400V000	Profim TABLES SV40 <ul style="list-style-type: none"> <li>• table, round</li> <li>• Ø 600</li> <li>• height 450 mm</li> <li>• wire frame</li> <li>• frame: black</li> </ul>		1 602	
MQC400W000	Profim TABLES SW40 <ul style="list-style-type: none"> <li>• table, round</li> <li>• Ø 600</li> <li>• height 450 mm</li> <li>• wooden legs (Beech): H5, H6, H12</li> </ul>		2 708	
MQC400H000	Profim TABLES SH40 <ul style="list-style-type: none"> <li>• low table, round</li> <li>• Ø 600</li> <li>• height 450 mm</li> <li>• metal legs</li> <li>• frame: black</li> </ul>		1 957	
MQC300H000	Profim TABLES SH30 <ul style="list-style-type: none"> <li>• medium table, round</li> <li>• Ø 600</li> <li>• height 600 mm</li> <li>• metal legs</li> <li>• frame: black</li> </ul>		1 981	
MQC400R000	Profim TABLES SR40 <ul style="list-style-type: none"> <li>• low table, round</li> <li>• Ø 600</li> <li>• height 450 mm</li> <li>• round base</li> <li>• base: black</li> </ul>		2 266	
MQC300R000	Profim TABLES SR30 <ul style="list-style-type: none"> <li>• medium table, round</li> <li>• Ø 600</li> <li>• height 600 mm</li> <li>• round base</li> <li>• base: black</li> </ul>		2 281	

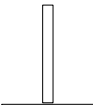
Item no	Base model +	Price Group (PG)	Tempered glass (G1)	Price
MQC40H000F	Profim TABLES SH40 FRAME <ul style="list-style-type: none"> <li>table's frame, low</li> <li>height 440 mm</li> <li>metal legs</li> <li>frame: black</li> </ul>			1 199
MQC30H000F	Profim TABLES SH30 FRAME <ul style="list-style-type: none"> <li>table's frame, medium</li> <li>height 590 mm</li> <li>metal legs</li> <li>frame: black</li> </ul>			1 223
MQC40R000F	Profim TABLES SR40 FRAME <ul style="list-style-type: none"> <li>table's frame, low</li> <li>height 440 mm</li> <li>round base</li> <li>base: black</li> </ul>			1 516
MQC30R000F	Profim TABLES SR30 FRAME <ul style="list-style-type: none"> <li>table's frame, medium</li> <li>height 590 mm</li> <li>round base</li> <li>base: black</li> </ul>			1 539
<b>Accessories/Options/Surcharges:</b>				
	Oak wood - HO6, HO12, HO11 (Only for: SW40)			209
	Table top HPL (Only for: SH30, SR30, SH40, SR40)			1 091
7COPR002	Frames colours: MetallicPro, White RAL 9016, Deep Green RAL 6004, Navy Blue RAL 5003, Burgundy RAL 3005, Salvia/Green RAL 6021, Blue RAL 5014, Terracota RAL 3012 (Only for: SH30, SR30, SR30 FRAME, SH40, SR40, SV40, SR40 FRAME)			24
7COPR003	Frames colours: Lightgrey NCS S 2500-N; Grey NCS S 6500-N (Only for: SH30, SR30, SH30 FRAME, SR30 FRAME, SH40, SR40, SV40, SH40 FRAME, SR40 FRAME)			141

**Table top: tempered glass: G1 (milky)**

Colours of HPL White (LW01), Light Grey (LW03); Grey (LW04), Black (LW02), Navy Blue (LW06), Light Burgundy (LW07) - lead time 20-30 working days.





Frame in Tables SH is dedicated for assembly table tops made only from chipboard, plywood or wood. Self-assembly is not possible in case of glass table tops. Maximum parameters of the table top: Ø 600 mm.





Frame in Tables SR is dedicated for assembly table tops made only from chipboard, plywood or wood. Self-assembly is not possible in case of glass table tops. Maximum parameters of the table top: Ø 900 mm, weight 7,0 kg.

# Profim U-CONNECT

Acer Design a/s, Justus Kolberg, Erik Simonsen

- Folding tables
- A smart mobile folding table with wheels and can nest together when lined up in the vertical position. The table top is anchored with a bracket in the upright position. The table top can be tipped along its long axis
- Table top edge band will match table top colour as standard. Optionally choose black, white or grey table edge band to any table top colour within our range without extra charge.
- Table top in Laminate or Linoleum (24 mm) and Melamine Beech (22 mm)

Item no	Base model +	Price Group (PG)	①	②	③	Price
3490-22	Profim U-CONNECT 3490-22 (S) <ul style="list-style-type: none"> <li>• 180 x 80 cm</li> <li>• Distance between the table legs 163 cm</li> <li>• Weight appr 31.6 kg Lam.</li> </ul>		6 879	8 514	11 067	
3490-36	Profim U-CONNECT 3490-36 (S) <ul style="list-style-type: none"> <li>• 180 x 70 cm</li> <li>• Distance between the table legs 163 cm</li> <li>• Weight appr 28.7 kg Lam.</li> </ul>		6 809	8 317	10 812	
3490-24	Profim U-CONNECT 3490-24 (S) <ul style="list-style-type: none"> <li>• 160 x 80 cm</li> <li>• Distance between the table legs 143 cm</li> <li>• Weight appr 28.7 kg Lam.</li> </ul>		6 255	7 737	10 059	
3490-37	Profim U-CONNECT 3490-37 (S) <ul style="list-style-type: none"> <li>• 160 x 70 cm</li> <li>• Distance between the table legs 143 cm</li> <li>• Weight appr 26.1 kg Lam.</li> </ul>		6 187	7 562	9 830	
3490-25	Profim U-CONNECT 3490-25 (S) <ul style="list-style-type: none"> <li>• 140 x 80 cm</li> <li>• Distance between the table legs 123 cm</li> <li>• Weight appr 25.4 kg Lam.</li> </ul>		5 688	7 036	9 146	

Item no	Base model +	Price Group (PG)	①	②	③	Price
3490-38	Profim U-CONNECT 3490-38 (S) <ul style="list-style-type: none"> <li>• 140 x 70 cm</li> <li>• Distance between the table legs 123 cm</li> <li>• Weight appr 23.2 kg Lam.</li> </ul>		5 624	6 874	8 936	
3490-52	Profim U-CONNECT 3490-52 (S) <ul style="list-style-type: none"> <li>• 140 x 60 cm</li> <li>• Distance between the table legs 123 cm</li> <li>• Weight appr 21 kg Lam.</li> </ul>		5 563	6 756	8 783	
3490-27	Profim U-CONNECT 3490-27 (S) <ul style="list-style-type: none"> <li>• 120 x 80 cm</li> <li>• Distance between the table legs 103 cm</li> <li>• Weight appr 22.6 kg Lam.</li> </ul>		5 607	6 840	8 893	
3490-39	Profim U-CONNECT 3490-39 (S) <ul style="list-style-type: none"> <li>• 120 x 70 cm</li> <li>• Distance between the table legs 103 cm</li> <li>• Weight appr 21.6 kg Lam.</li> </ul>		5 551	6 700	8 711	
3490-54	Profim U-CONNECT 3490-54 (S) <ul style="list-style-type: none"> <li>• 120 x 60 cm</li> <li>• Distance between the table legs 103 cm</li> <li>• Weight appr 18.5 kg Lam.</li> </ul>		5 496	6 564	8 534	

#### Accessories/Options/Surcharges:

PHFILIP8	Additional price* for polished aluminium legs	1 027
----------	---	-------

1. Melamine on chipboard (only beech)
2. Laminate on chipboard
3. Linoleum on chipboard

Height 73.5 cm

Features Ø65 mm castors with soft rim and brake

Profim u-Connect table tops (rectangular and squared shapes) can be made available with MDF table core, chamfered edges of 20 degr and with a 10 mm black, white or grey edge band and black paint (see extra charge below)



RBM u-Connect

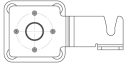

115000338008

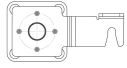

115000338009

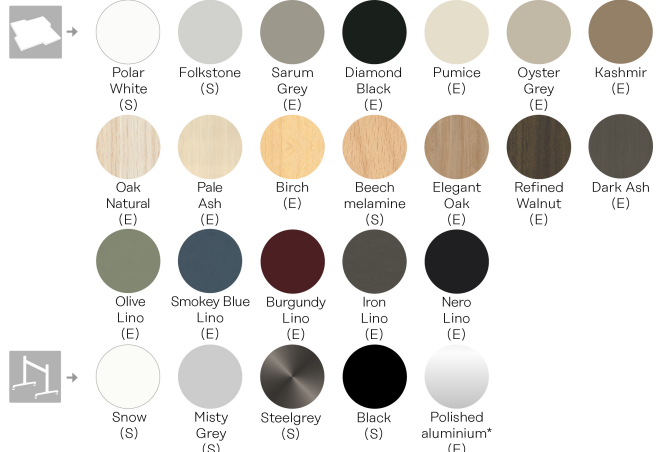

S=Standard Collection – normal production time 20-30 working days. Applicable when table top and base are standard (S).

E=Extended Collection – normal production time 30-35 working days (Linoleum: 35 working days). Applicable when any or all component options selected are extended (E).

For larger orders, please contact Customer Service for delivery details.

Lightweight core on request.



MÖBELAKTA

# Profim SEVEN

Tomek Rygalik, Studio Rygalik

- Option of combining colours, it is possible to play with colours (hanger and hooks are available in different shades)

Item no	Base model +	Price Group (PG)	Coat hanger	Price
MSZ0000000	Profim SEVEN • coat hanger			1 536

Hard glides - for soft floors (set).



Colours of frame:

- Black RAL 9005
- MetallicPro
- White RAL 9016
- Lightgrey NCS S 2500-N
- Grey NCS S 6500-N
- Deep green RAL 6004
- Navy blue RAL 5003
- Burgundy RAL 3005
- Salvia/Green RAL 6021
- Blue RAL 5014
- Terracota RAL 3012
- Steelgray

It is possible to order hooks in different colour than the coat stand frame.

# Profim CUSHION

- Two sizes
- Several types of fabric

Item no	Base model +	Price Group (PG)	①	②	③	④	Price
MCU3000000	Profim CUSHION CU30 • cushions with filling • 300 x 300 mm		302	480	500	750	
MCU4000000	Profim CUSHION CU40 • cushions with filling • 400 x 400 mm		355	518	539	874	

**1 price group: Cura, Tonal, Xtreme**

**2 price group: Select**

**3 price group: Capture, Oceanic, Step, Synergy**

**4 price group: Steelcut 3, Steelcut Trio 3**

Filling: silicon.

Weight:

CU30 - 0,15 kg,

CU40 - 0,25 kg.

Colour of pillowcase is always white.



Technical details

# Type of packaging

Box type legend: A - 670x730x955, 3,2Kg, 0,47m<sup>3</sup> B - 670x730x1160, 3,6Kg, 0,5m<sup>3</sup>

	Product netto weight (Kg)	1 pc	2 pcs	3 pcs	4 pcs	5 pcs	Box Info	Comments
		Box type	Box type	Box type	Box type	Box type		
<b>Acos<sup>Pro</sup></b>								
30H	10,5	A	-	-	-	-	1 pc/box A	
30V	12,5	A	B	-	-	-	1-2 pcs/box B	
<b>Arca</b>								
21V	8,5	A	-	-	-	-	1 pc/box A	
<b>Ariz</b>								
550CV	8	B	B	-	-	-	1-2 pcs/box B	
550V	6,5	A	A	B	B	B	1-2 pcs/box A 3-5 pcs/box B	
555CV	7,5	B	B	-	-	-	1-2 pcs/box B	
555V	6	A	A	B	B	B	1-2 pcs/box A 3-5 pcs/box B	
560CV	8,5	B	B	-	-	-	1-2 pcs/box B	
560V	7	A	A	B	B	B	1-2 pcs/box A 3-5 pcs/box B	
570CV	9	B	B	-	-	-	1-2 pcs/box B	
570V	7,5	A	A	B	B	B	1-2 pcs/box A 3-5 pcs/box B	
575CV	8	A	B	-	-	-	1-2 pcs/box B	
575V	6,5	A	A	B	B	B	1-2 pcs/box A 3-5 pcs/box B	
<b>Bit</b>								
550H	5,5	A	A	B	-	-	1-2 pcs/box A 3-3 pcs/box B	
550V	7,5	A	A	B	-	-	1-2 pcs/box A 3-3 pcs/box B	
555H	5,5	A	A	B	-	-	1-2 pcs/box A 3-3 pcs/box B	
555V	7,5	A	A	B	-	-	1-2 pcs/box A 3-3 pcs/box B	
560H	6,5	A	A	B	-	-	1-2 pcs/box A 3-3 pcs/box B	
560V	8	A	A	B	-	-	1-2 pcs/box A 3-3 pcs/box B	
570H	7	A	A	B	-	-	1-2 pcs/box A 3-3 pcs/box B	
570V	8,5	A	A	B	-	-	1-2 pcs/box A 3-3 pcs/box B	
575H	6,5	A	A	B	-	-	1-2 pcs/box A 3-3 pcs/box B	
575V	8	A	A	B	-	-	1-2 pcs/box A 3-3 pcs/box B	
580H	7	A	B	B	-	-	1-1 pc/box A 2-3 pcs/box B	
580V	9,5	A	B	B	-	-	1-1 pc/box A 2-3 pcs/box B	

# Type of packaging

Box type legend: A - 670x730x955, 3,2Kg, 0,47m<sup>3</sup> B - 670x730x1160, 3,6Kg, 0,5m<sup>3</sup>

	Product netto weight (Kg)	1 pc	2 pcs	3 pcs	4 pcs	5 pcs	Box Info	Comments
		Box type	Box type	Box type	Box type	Box type		
<b>Com</b>								
K12CV	7,5	B	-	-	-	-	1 pc/box B	
K12H	5,5	A	-	-	-	-	1 pc/box A	with writing table
K12H	5,5	A	A	B	B	B	1-2 pcs/box A 3-5 pcs/box B	without writing table
K12HC	7,5	A	-	-	-	-	1 pc/box A	
K12HF	7,5	A	-	-	-	-	1 pc/box A	
K12HS	7,5	A	-	-	-	-	1 pc/box A	
K12V	6,5	A	A	B	B	B	1-2 pcs/box A 3-5 pcs/box B	Cantliver V
K12V	6,5	A	A	B	-	-	1-2 pcs/box A 3-3 pcs/box B	Cantliver V1;V2
K22CV	8	B	-	-	-	-	1 pc/box B	
K22H	6	A	-	-	-	-	1 pc/box A	with writing table
K22H	6	A	A	B	B	B	1-2 pcs/box A 3-5 pcs/box B	without writing table
K22HC	8	A	-	-	-	-	1 pc/box A	
K22HF	8	A	-	-	-	-	1 pc/box A	
K22HS	8	A	-	-	-	-	1 pc/box A	
K22V	7	A	A	B	B	B	1-2 pcs/box A 3-5 pcs/box B	Cantliver V
K22V	7	A	A	B	B	B	1-2 pcs/box A 3-3 pcs/box B	Cantliver V1;V2
K32H	6,5	A	-	-	-	-	1 pc/box A	with writing table
K32H	6,5	A	A	B	B	B	1-2 pcs/box A 3-5 pcs/box B	without writing table
K32HC	8,5	A	-	-	-	-	1 pc/box A	
K32HF	8,5	A	-	-	-	-	1 pc/box A	
K32HS	8,5	A	-	-	-	-	1 pc/box A	
K32V	7,5	A	A	B	B	B	1-2 pcs/box A 3-5 pcs/box B	Cantliver V
K32V	7,5	A	A	B	-	-	1-2 pcs/box A 3-3 pcs/box B	Cantliver V1;V2
K42CV	8	B	-	-	-	-	1 pc/box B	
K42H	6	A	-	-	-	-	1 pc/box A	with writing table
K42H	6	A	A	B	B	B	1-2 pcs/box A 3-5 pcs/box B	without writing table
K42HC	9,5	A	-	-	-	-	1 pc/box A	
K42HF	9,5	A	-	-	-	-	1 pc/box A	
K42HS	9,5	A	-	-	-	-	1 pc/box A	
K42V	7	A	A	B	B	B	1-2 pcs/box A 3-5 pcs/box B	Cantliver V
K42V	7	A	A	B	-	-	1-2 pcs/box A 3-3 pcs/box B	Cantliver V1;V2

# Type of packaging

Box type legend: A - 670x730x955, 3,2Kg, 0,47m<sup>3</sup> B - 670x730x1160, 3,6Kg, 0,5m<sup>3</sup>

	Product netto weight (Kg)	1 pc	2 pcs	3 pcs	4 pcs	5 pcs	Box Info	Comments
		Box type	Box type	Box type	Box type	Box type		
<b>Chic</b>								
20F	10,5	A	-	-	-	-	1 pc/box A	
20H	9,5	A	-	-	-	-	1 pc/box A	
21F	10,5	A	-	-	-	-	1 pc/box A	
21H	9	A	-	-	-	-	1 pc/box A	
20CH	11	B	-	-	-	-	1 pc/box B	
20CR	25	B	-	-	-	-	1 pc/box B	
21CH	10	B	-	-	-	-	1 pc/box B	
21CR	24	B	-	-	-	-	1 pc/box B	
<b>Ellie<sup>Pro</sup></b>								
10 HST	16	B	-	-	-	-	1 pc/box B	
10 HW	15	B	-	-	-	-	1 pc/box B	
10 V3	16	B	-	-	-	-	1 pc/box B	
20 HST	15	B	-	-	-	-	1 pc/box B	
20 HW	14	B	-	-	-	-	1 pc/box B	
20 V3	15	B	-	-	-	-	1 pc/box B	
<b>Fan</b>								
10F	11,5	A	-	-	-	-	1 pc/box A	
10H	10,5	A	-	-	-	-	1 pc/box A	
10V	10,5	A	-	-	-	-	1 pc/box A	
10R	23	A	-	-	-	-	1 pc/box A	
<b>MyTurn</b>								
21VN	12,5	B	-	-	-	-	1 pc/box B	Non stackable cantliver
<b>Normo</b>								
500H	7	A	A	B	B	-	1-2 pcs/box A 3-4 pcs/box B	
500HC	9	A	-	-	-	-	1 pc/box A	
500HS	9,5	A	-	-	-	-	1 pc/box A	
500V	11,5	A	-	-	-	-	1 pc/box A	with long armrest
500V	8	A	A	B	B	-	1-2 pcs/box A 3-4 pcs/box B	without long armrest
<b>Nu</b>								
20F	12	A	-	-	-	-	1 pc/box A	
20H	11	A	-	-	-	-	1 pc/box A	
20R	22	A	-	-	-	-	1 pc/box A	
20V3	11	A	-	-	-	-	1 pc/box A	

# Type of packaging

Box type legend: A - 670x730x955, 3,2Kg, 0,47m<sup>3</sup> B - 670x730x1160, 3,6Kg, 0,5m<sup>3</sup>

	Product netto weight (Kg)	1 pc	2 pcs	3 pcs	4 pcs	5 pcs	Box Info	Comments
		Box type	Box type	Box type	Box type	Box type		
<b>Sun</b>								
H	5	A	B	B	-	-	1-1 pc/box A 2-3 pcs/box B	with writing table
H	5	A	B	B	B	-	1-1 pc/box A 2-4 pcs/box B	without writing table
H 2P	6	A	B	B	-	-	1-1 pc/box A 2-3 pcs/box B	with writing table
H 2P	6	A	B	B	B	-	1-1 pc/box A 2-4 pcs/box B	without writing table
V 2P	9,5	A	B	B	-	-	1-1 pc/box A 2-3 pcs/box B	with writing table
V 2P	9,5	A	B	B	-	-	1-1 pc/box A 2-3 pcs/box B	without writing table
<b>Xenon</b>								
20H	9,5	A	A	B	-	-	1-2 pcs/box A 3-3 pcs/box B	
20V	12	A	B	B	-	-	1-1 pc/box A 2-3 pcs/box B	
<b>Xenon Net</b>								
20H	9	A	A	B	-	-	1-2 pcs/box A 3-3 pcs/box B	
20V	11,5	A	B	B	-	-	1-1 pc/box A 2-3 pcs/box B	
<b>Zoo</b>								
500 H	7,5	A	A	A	-	-	1-3 pcs /box A	without writing table and castors
500 H	7,5	A	-	-	-	-	1 pc/box A	with writing table and glide
500 HC	8	A	-	-	-	-	1 pc/box A	with castors
500 V	8,5	A	A	A	-	-	1-3 pcs /box A	without writing table
500 V	8,5	A	-	-	-	-	1 pc/box A	with writing table
502 H	7	A	A	A	-	-	1-3 pcs /box A	without writing table and castors
502 H	7	A	-	-	-	-	1 pc/box A	with writing table and glide
502 HC	7	A	-	-	-	-	1 pc/box A	with castors
502 V	8	A	A	A	-	-	1-3 pcs /box A	without writing table
502 V	8	A	-	-	-	-	1 pc/box A	with writing table
522 H	7	A	A	A	-	-	1-3 pcs /box A	without writing table and castors
522 H	7	A	-	-	-	-	1 pc/box A	with writing table and glide
522 HC	7,5	A	-	-	-	-	1 pc/box A	with castors
522 V	8	A	A	A	-	-	1-3 pcs /box A	without writing table
522 V	8	A	-	-	-	-	1 pc/box A	with writing table

# Technical details

## Allround

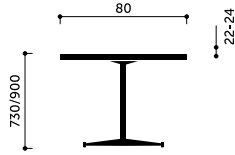

**Allround 5180-30**

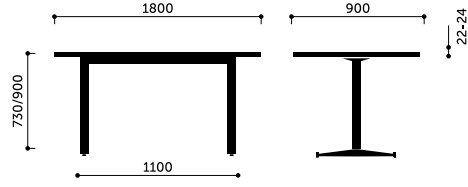

**Allround 5180-10**

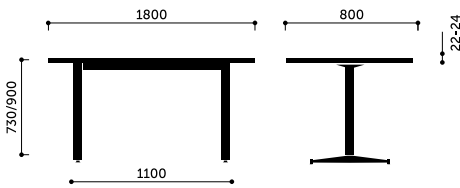

**Allround 5180-22**

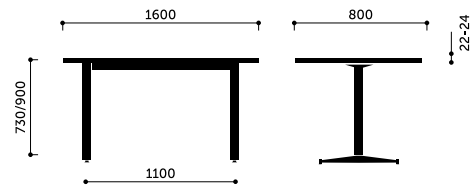

**Allround 5180-24**

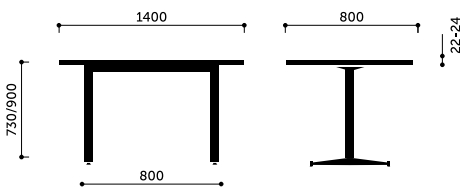

**Allround 5180-25**

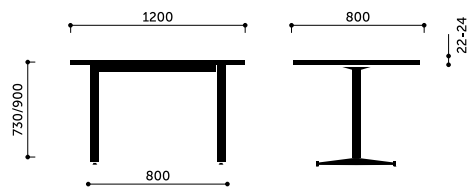

**Allround 5180-27**

# Technical details

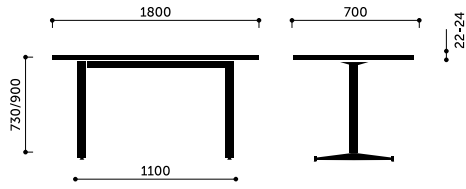

**Allround 5180-36**

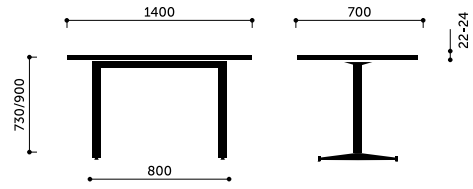

**Allround 5180-38**

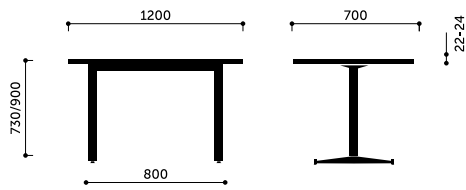

**Allround 5180-39**

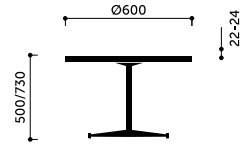

**Allround 5182-10**

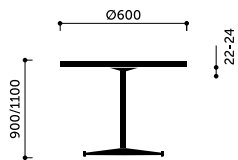

**Allround 5182-102**

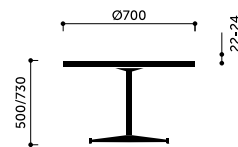

**Allround 5182-15**

# Technical details

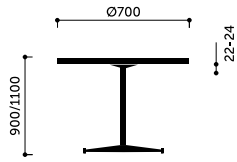

**Allround 5182-152**

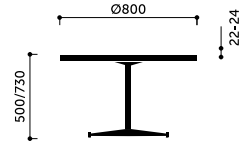

**Allround 5182-20**

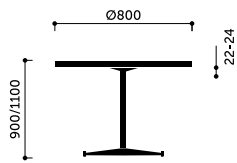

**Allround 5182-202**

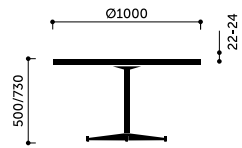

**Allround 5182-25**

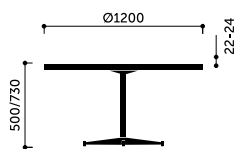

**Allround 5182-30**

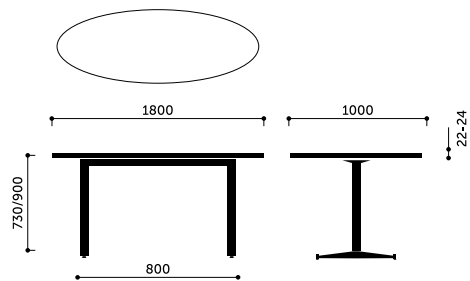

**Allround 5184-01**



# Technical details

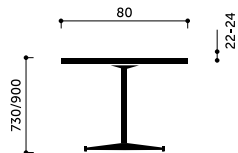

**Allround 5180-30**

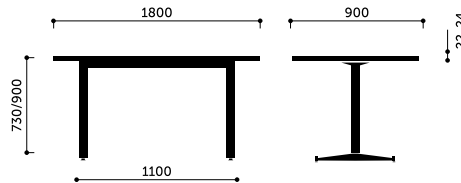

**Allround 5180-10**

## Ana

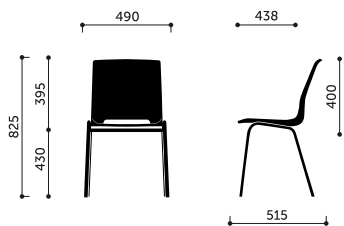

**4340 / 4340S / 4340SR**

## Ariz

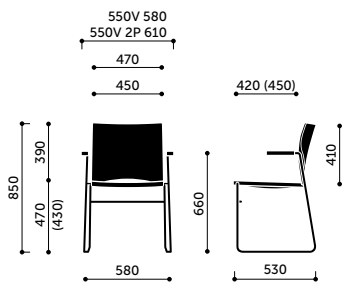

**550V / 550V 2P**

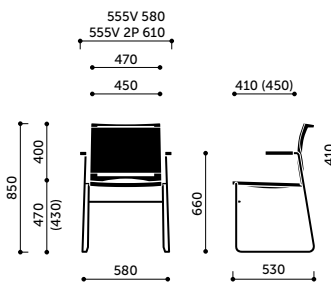

**555V / 555V 2P**

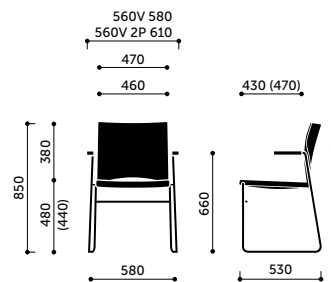

**560V / 560V 2P**

V	10,5	15	<p>0,50 m<sup>3</sup></p>
V	6,5	45	
V 2P	12,0	10	
V 2P	8,0	45	

V	6,0	15
V 2P	7,5	45
		10
		45

V	7,0	5
V 2P	8,5	20
		5
		20

# Technical details

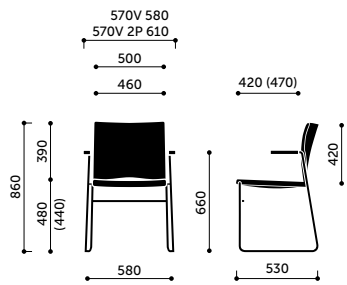

**570V / 570V 2P**

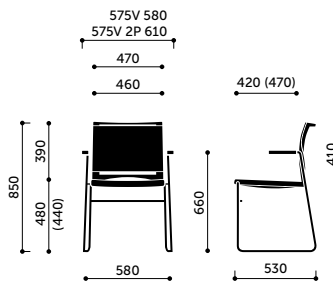
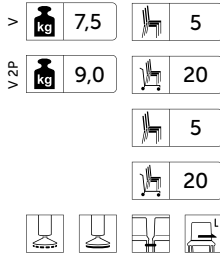

**575V / 575V 2P**

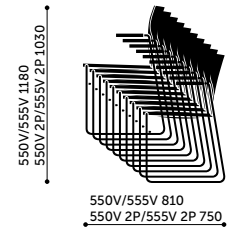
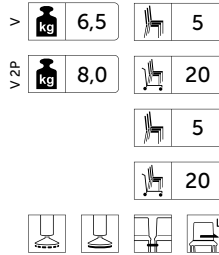

**stacking**

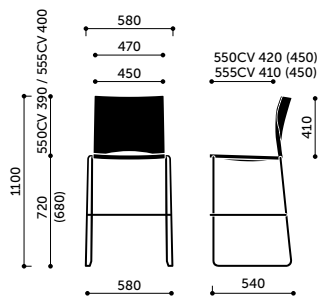

**550CV / 555CV**

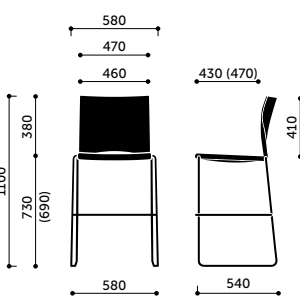
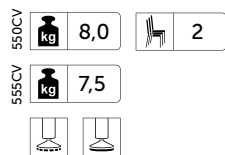

**560CV**

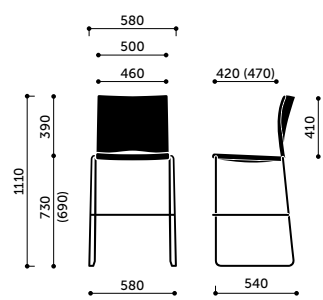

**570CV / 575CV**

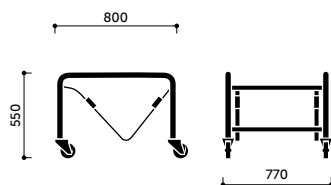
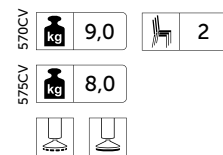

**W (chairs trolley)**

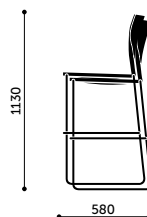

**stacking CV**

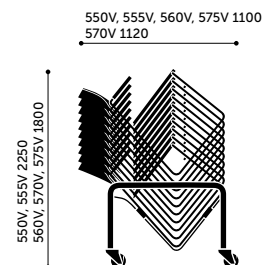

**stacking on trolley**

# Technical details

## Bit

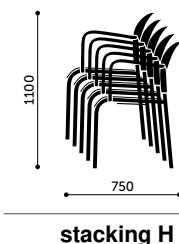
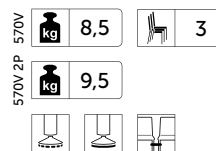
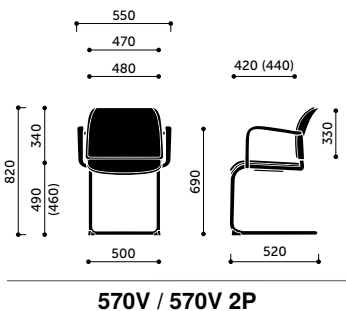
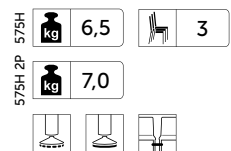
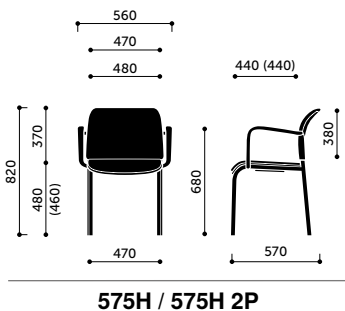
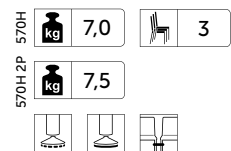
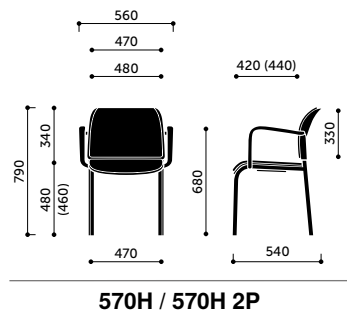
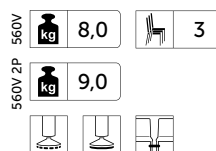
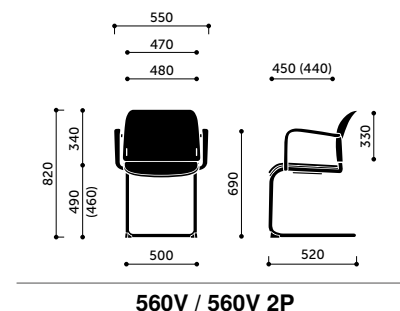
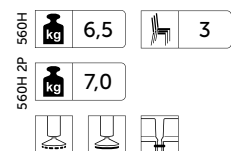
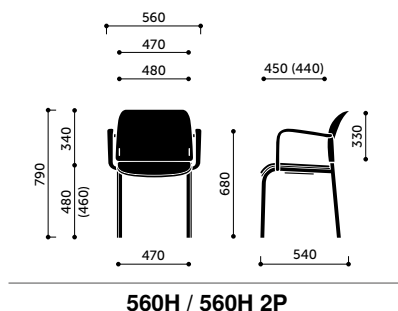
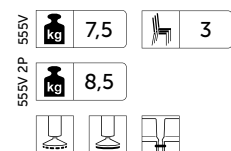
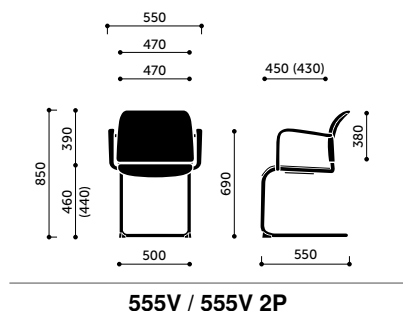
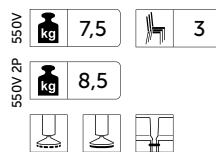
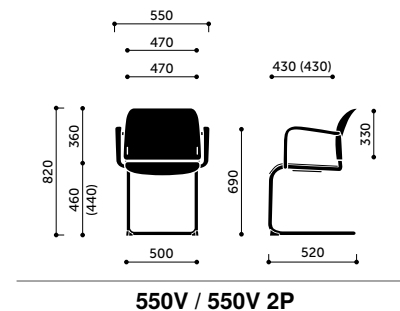
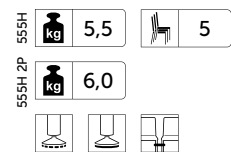
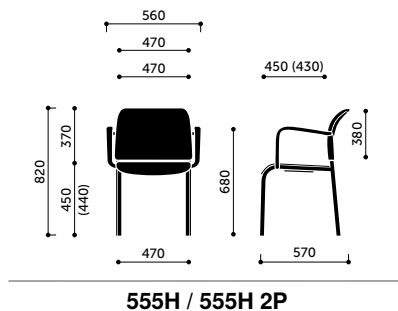
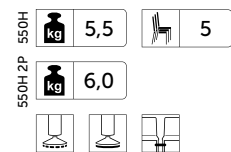
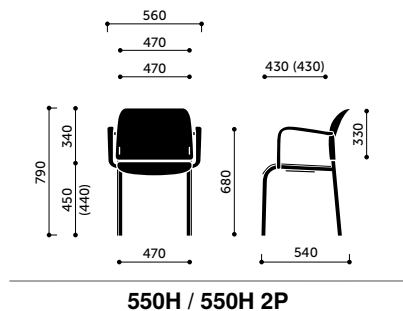

# Technical details

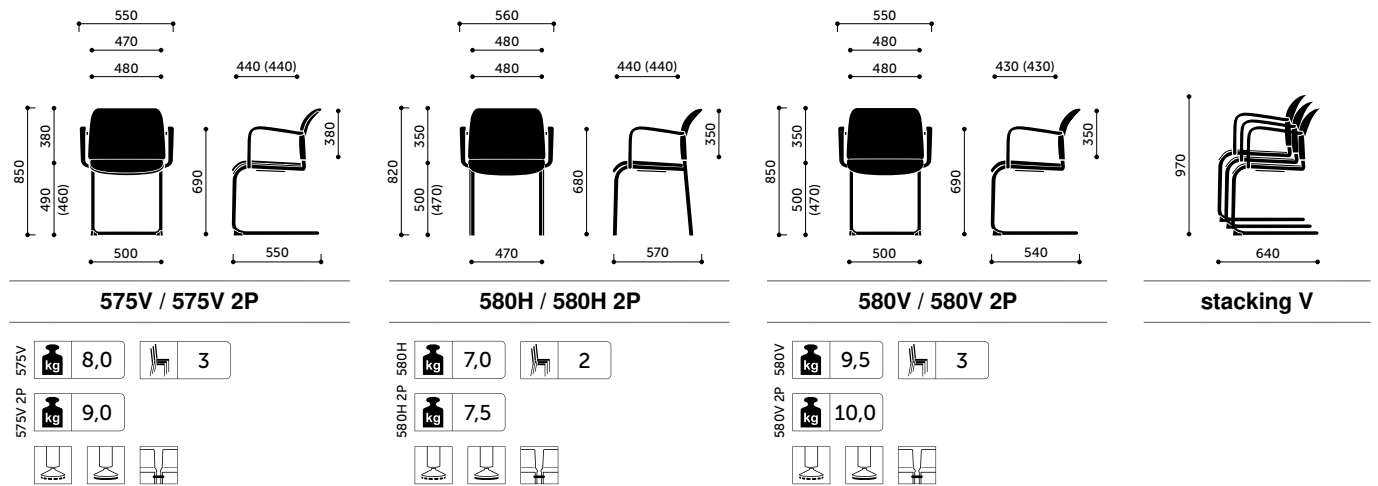

# Chic

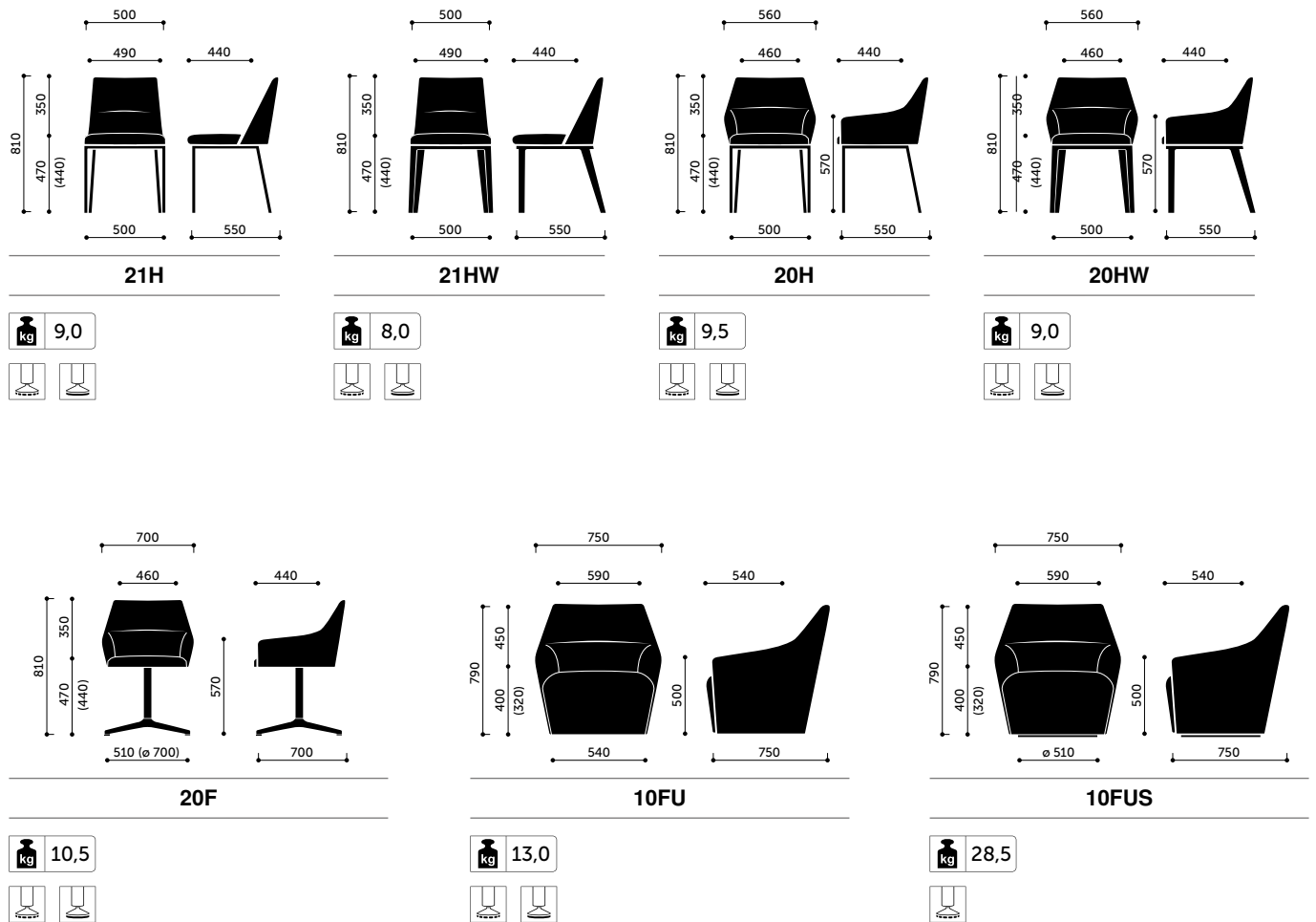

# Technical details

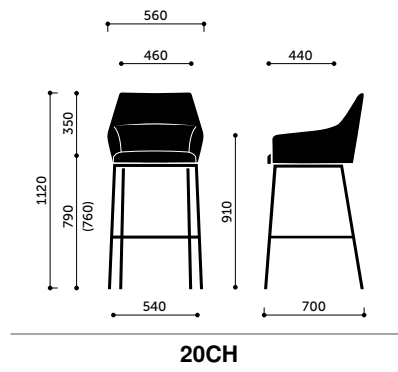
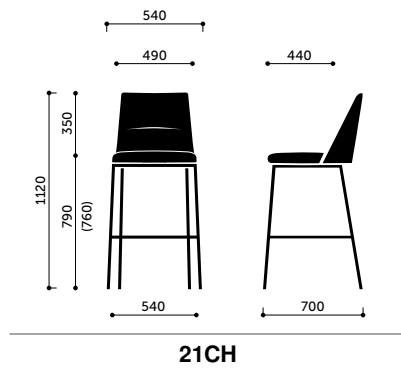

## Chic Lounge

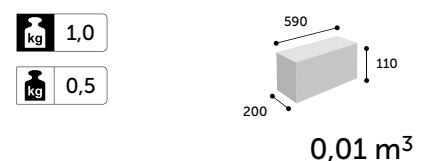
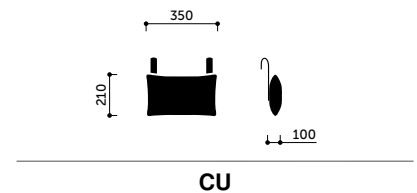
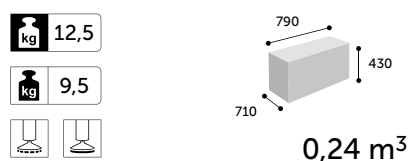
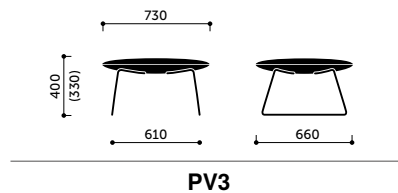
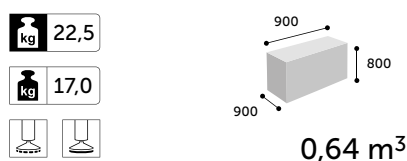
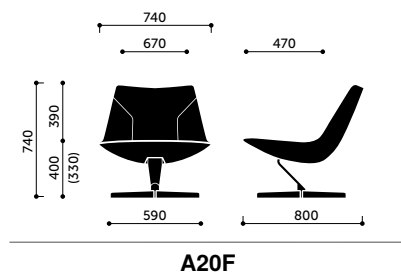
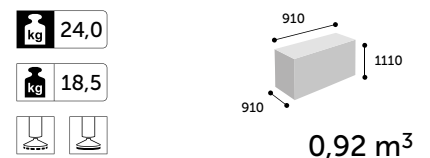
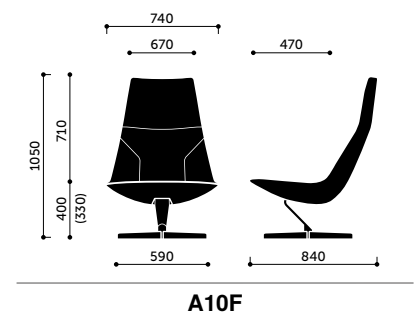
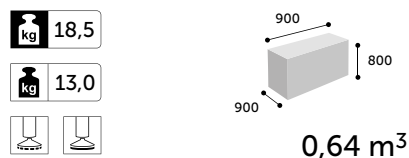
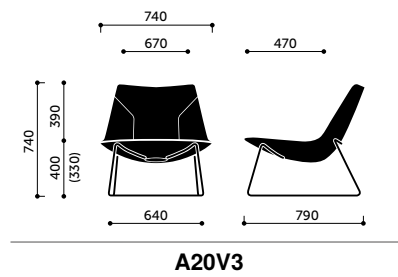
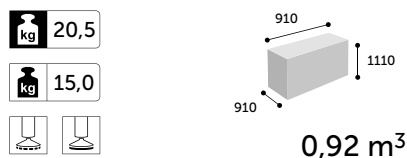
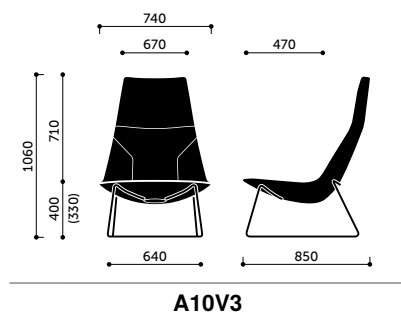

## Chic Tables

# Technical details

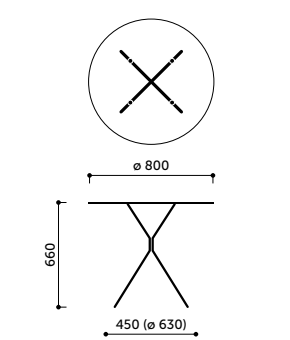

**RH30**

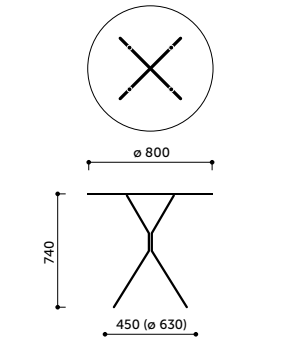
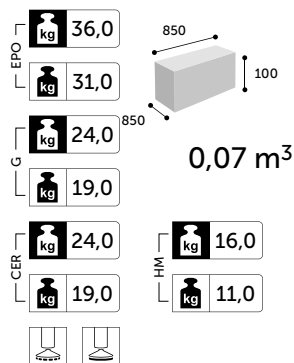

**RH20**

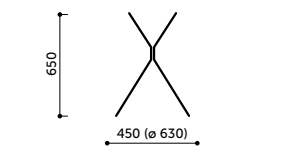
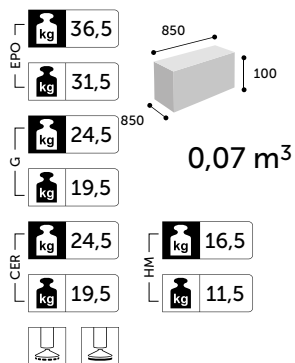

**frame RH30**

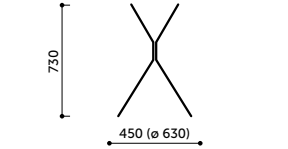
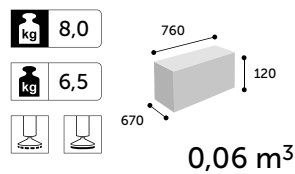

**frame RH20**

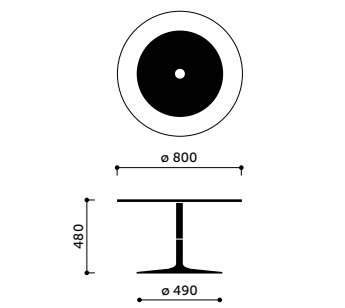
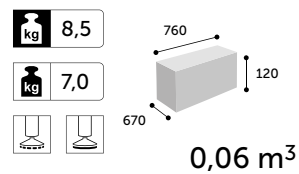

**RR40**

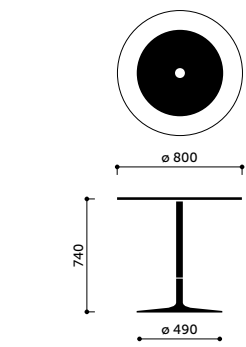
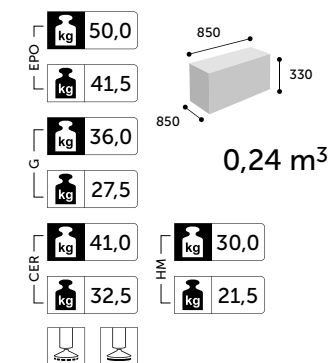

**RR20**

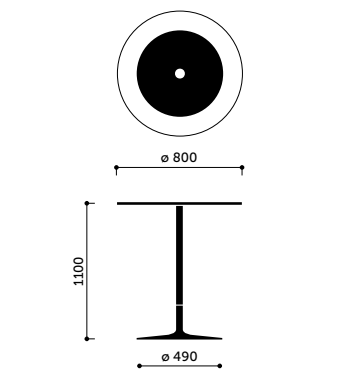
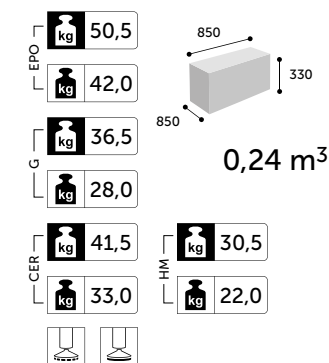

**RR10**

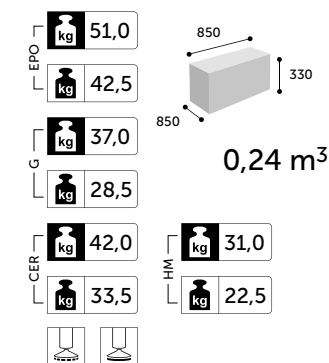

# Technical details

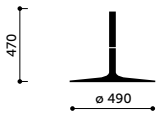

**frame RR40**

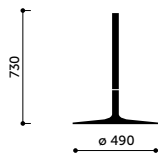
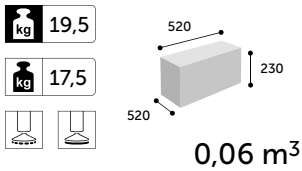

**frame RR20**

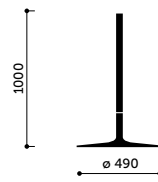
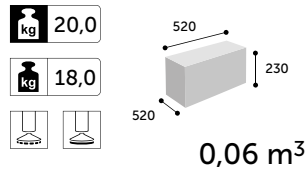

**frame RR10**

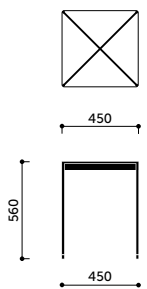
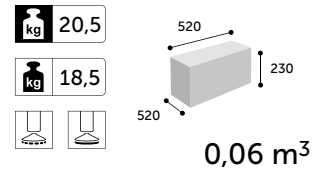

**CS30**

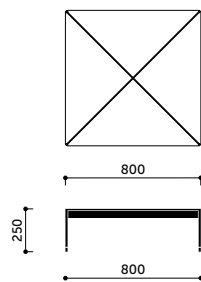
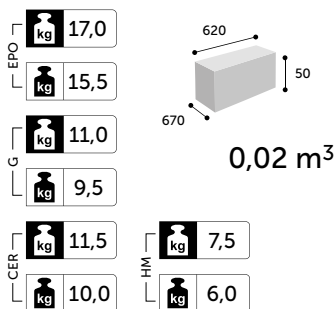

**CS40**

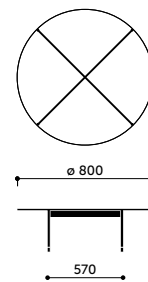
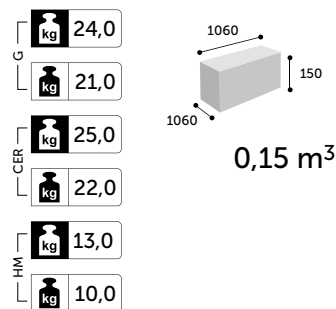

**CR40**

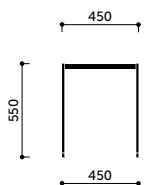
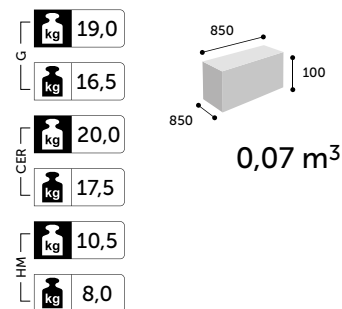

**frame CS30**

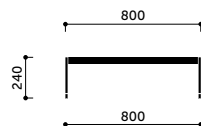
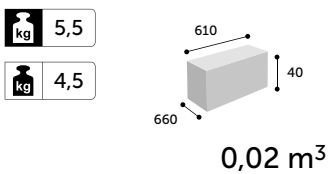

**frame CS40**

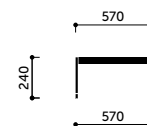
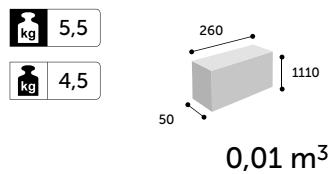

**frame CR40**

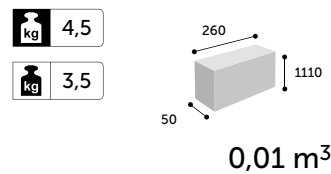

# Technical details

## Com

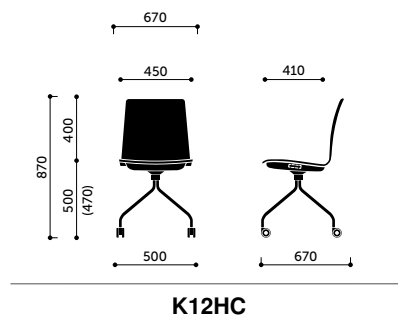
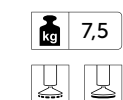
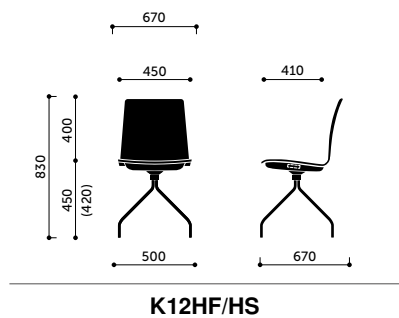
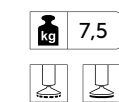
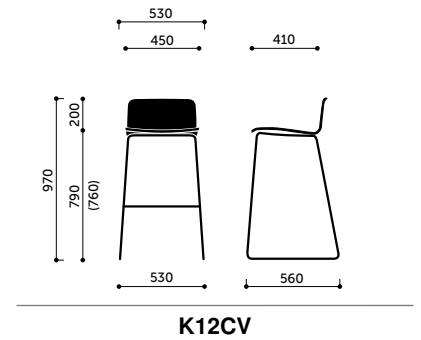
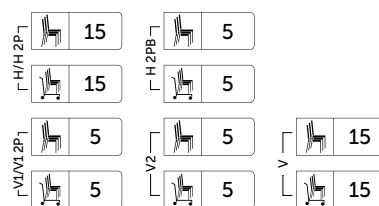
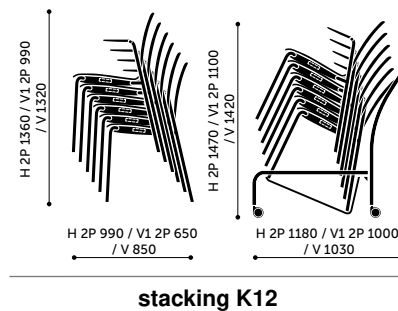
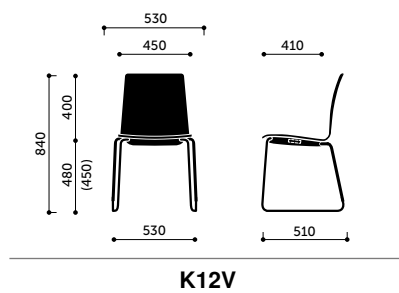
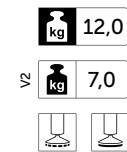
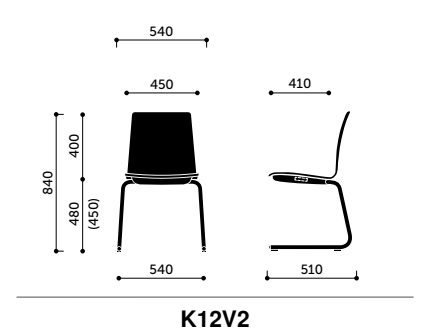
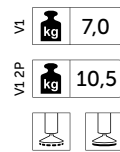
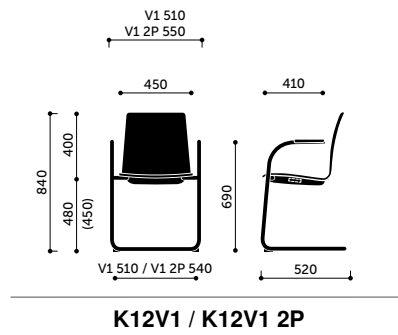
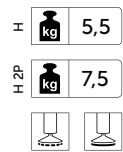
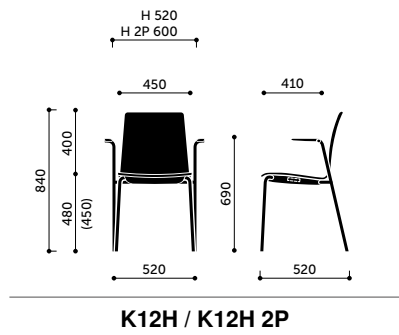



# Technical details

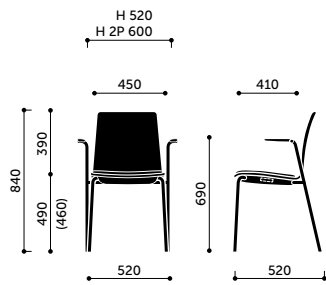

**K22H / K22H 2P**

H **kg** 6,0

H 2P **kg** 8,0

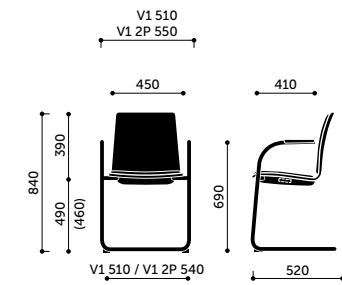

**K22V1 / K22V1 2P**

V1 **kg** 7,5

V1 2P **kg** 11,0

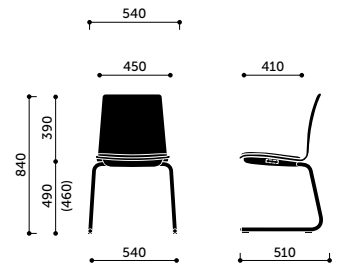
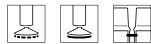

**K22V2**

V2 **kg** 7,5

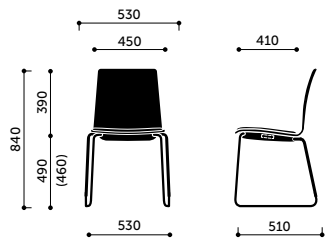

**K22V**

**kg** 7,0

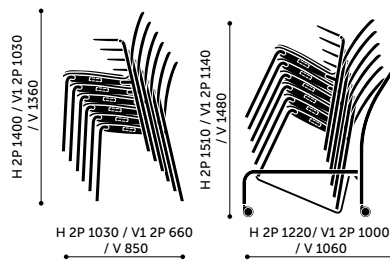

**stacking K22**

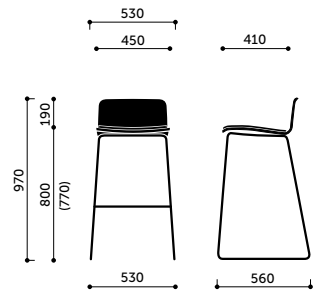
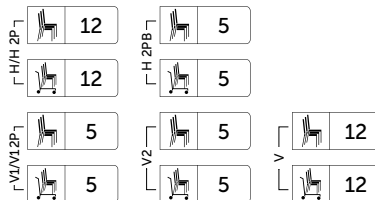

**K22CV**

**kg** 8,0

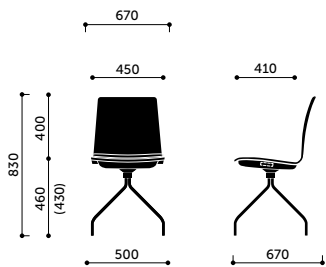

**K22HF/HS**

**kg** 8,0

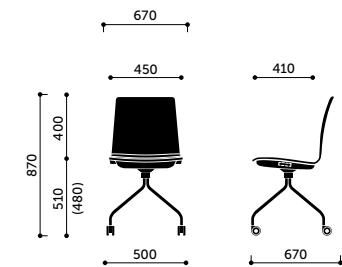

**K22HC**

**kg** 8,0

# Technical details

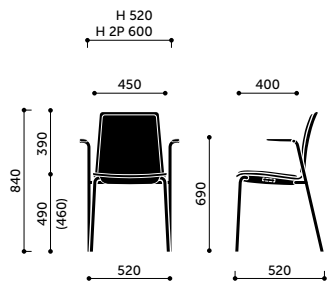

**K32H / K32H 2P**

H **kg** 6,5

H 2P **kg** 8,5

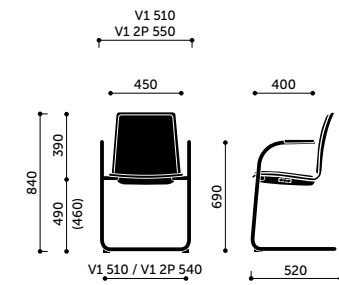

**K32V1 / K32V1 2P**

V1 **kg** 8,0

V1 2P **kg** 11,5

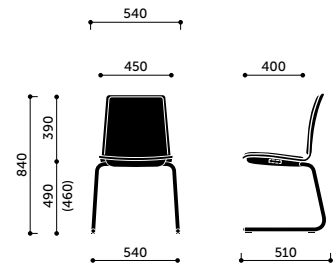
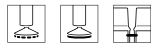

**K32V2**

V2 **kg** 8,0

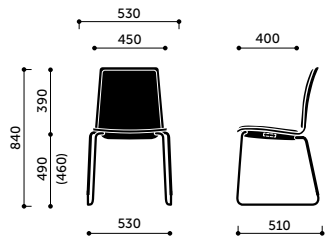

**K32V**

**kg** 7,5

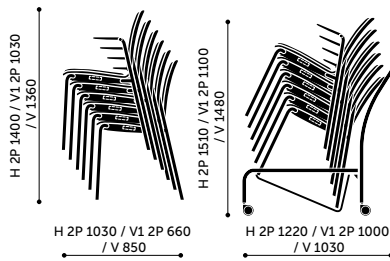

**stacking K32**

H/H 2P 12

H 5

H/H 2P 12

H 5

V1/V1 2P 5

V2 5

V 12

V1/V1 2P 5

V 5

V 12

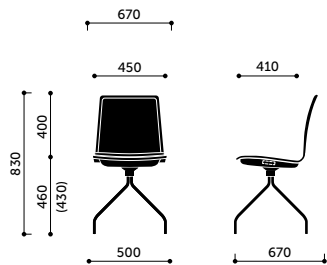

**K32HF/HS**

**kg** 8,5

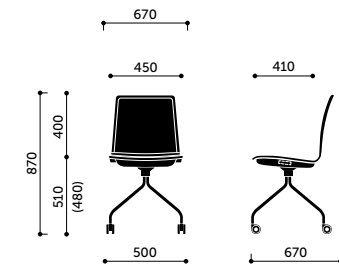

**K32HC**

**kg** 8,5

# Technical details

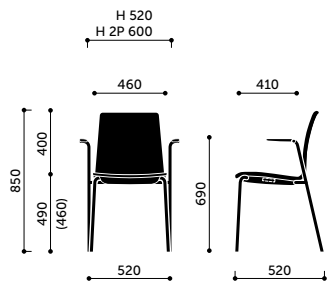

**K42H / K42H 2P**

H **kg** 6,0

H 2P **kg** 8,0

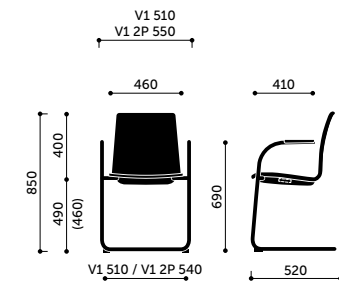

**K42V1 / K42V1 2P**

V1 **kg** 7,5

V1 2P **kg** 11,0

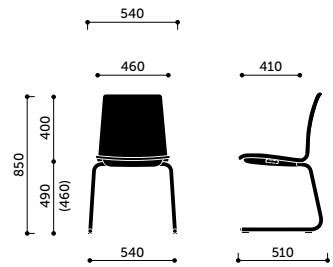
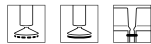

**K42V2**

V2 **kg** 7,5

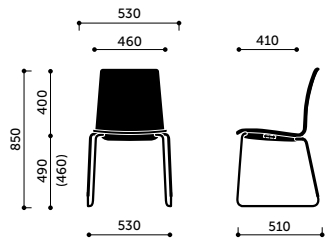

**K42V**

**kg** 7,0

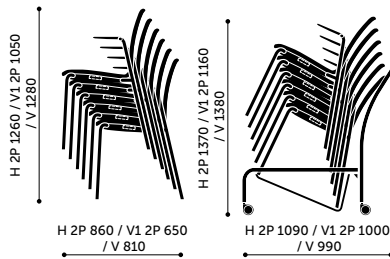

**stacking K42**

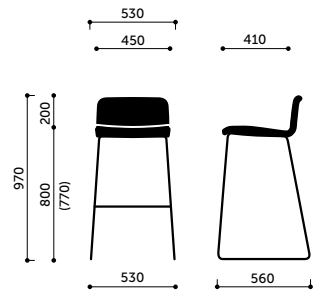
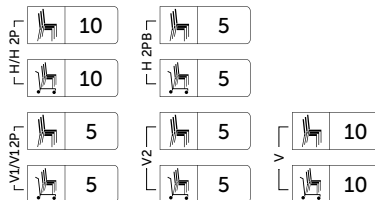

**K42CV**

**kg** 8,0

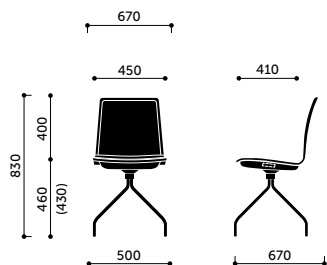

**K32HF/HS**

**kg** 8,5

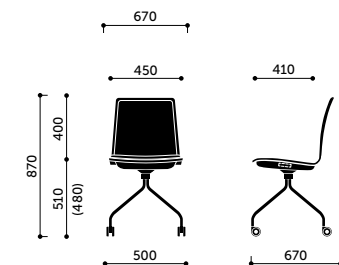

**K32HC**

**kg** 8,5

# Technical details

## Ellie<sup>Pro</sup>

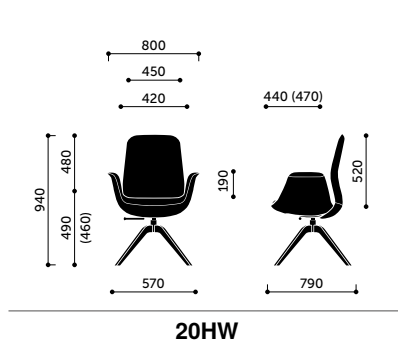
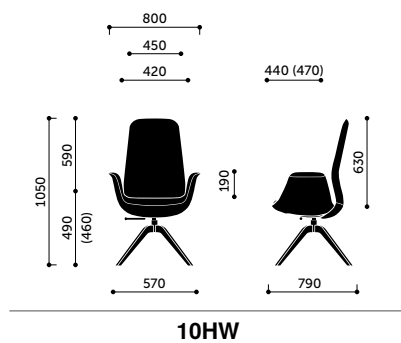
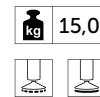
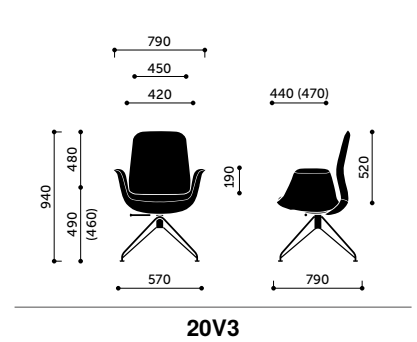
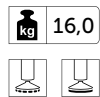
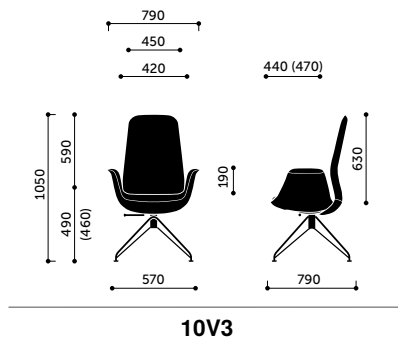
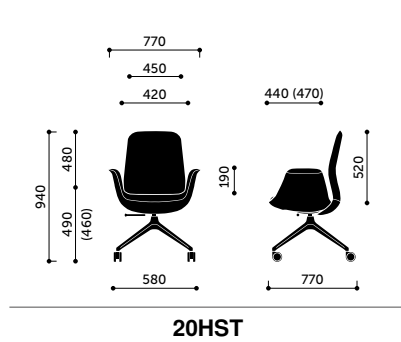
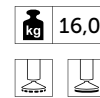
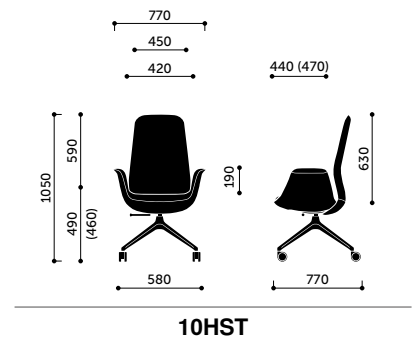
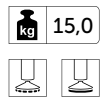
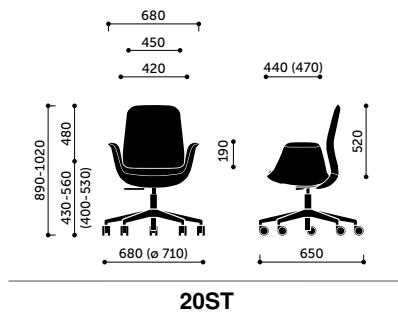
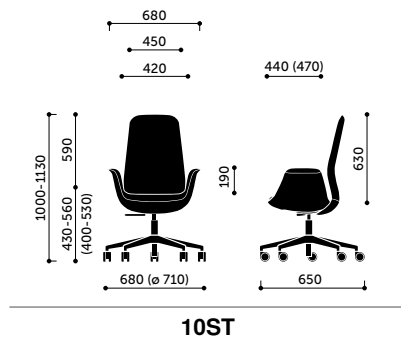

# Technical details

## Eminent

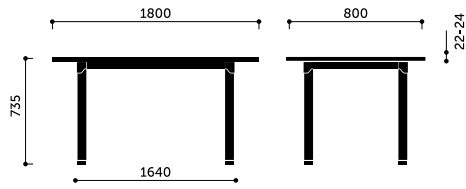

**Eminent 4590-22**

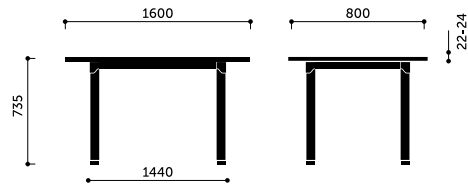

**Eminent 4590-24**

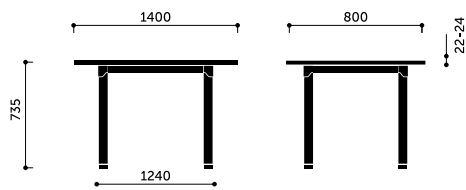

**Eminent 4590-25**

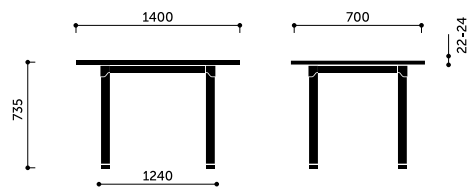

**Eminent 4590-38**

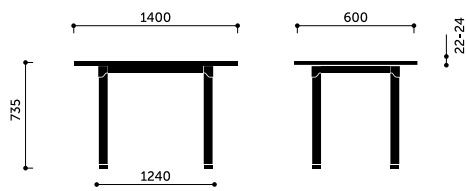

**Eminent 4590-52**

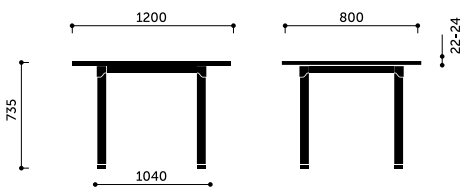

**Eminent 4590-27**

# Technical details

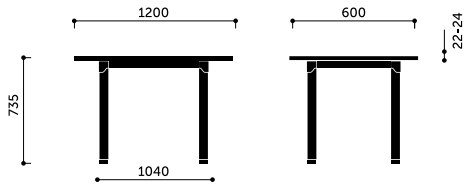

**Eminent 4590-54**

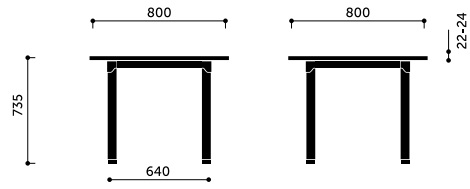

**Eminent 4590-30**

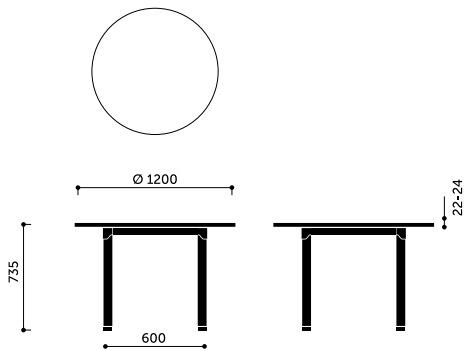

**Eminent 4592-30**

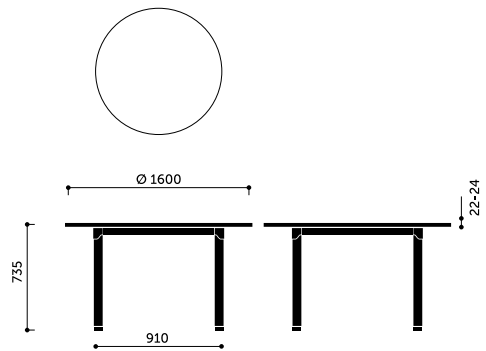

**Eminent 4592-50**

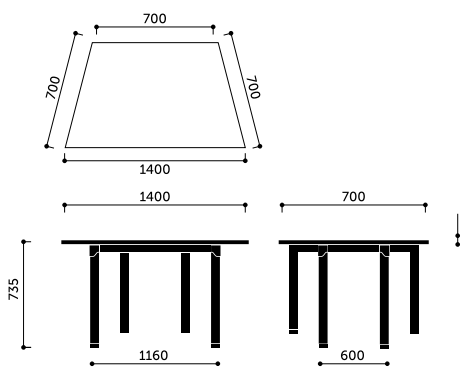

**Eminent 4592-50**

# Technical details

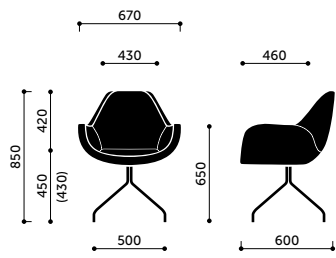

**10H / 10HS**

**kg** 10,5

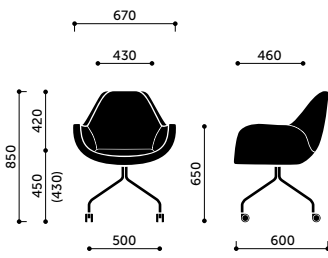

**10HC**

**kg** 10,5

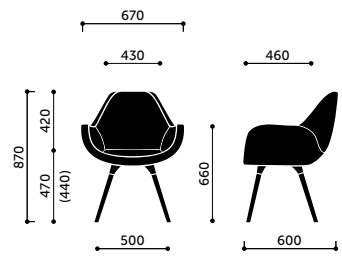

**10HW**

**kg** 9,5

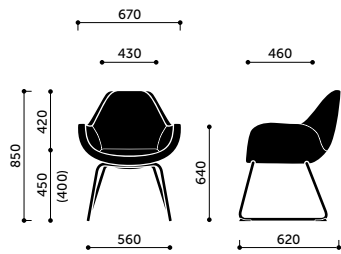

**10V**

**kg** 10,5

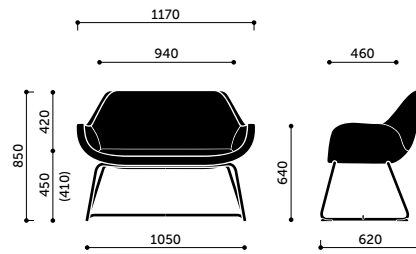

**20V**

**kg** 17,0

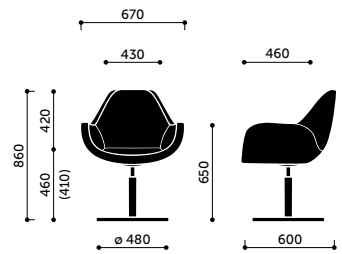

**10R**

**kg** 23,0

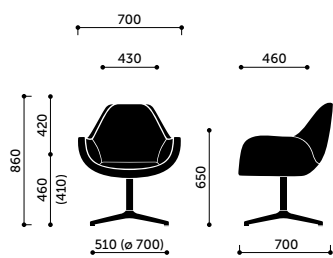

**10F**

**kg** 11,5

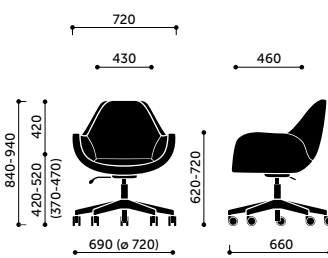

**10Z**

**kg** 12,0

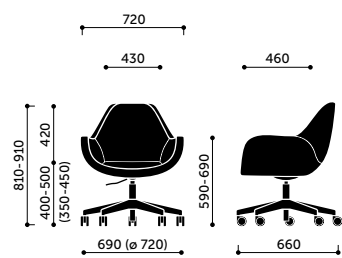

**10E**

**kg** 13,0



# Technical details

## Mickey

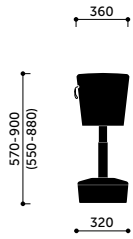

**Mickey**

kg 13,5

kg 11,5

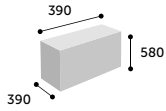

0,09 m<sup>3</sup>

## MyTurn Sofa

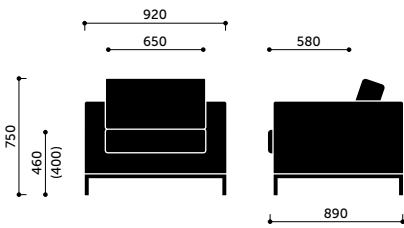

**10H / 10V**

kg 40,0

kg 35,0

kg 45,5

kg 40,5

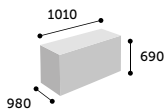

0,68 m<sup>3</sup>

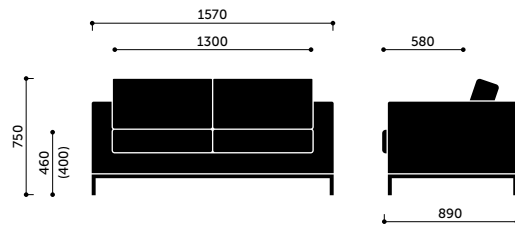

**20H / 20V**

kg 60,5

kg 54,0

kg 61,5

kg 55,0

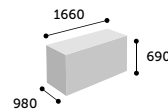

1,12 m<sup>3</sup>

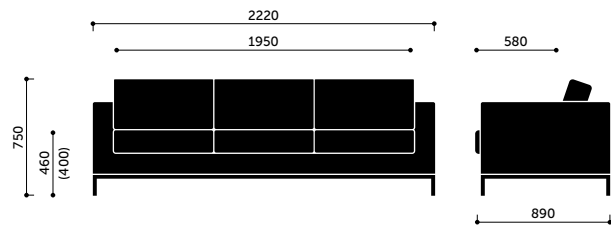

**30H / 30V**

kg 76,0

kg 67,5

kg 77,0

kg 68,5

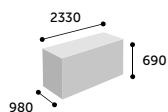

1,58 m<sup>3</sup>



# Technical details

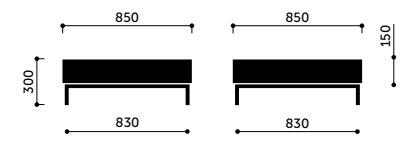

**S2H**

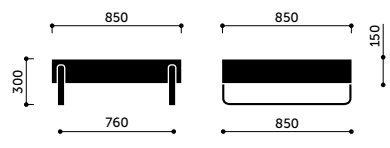
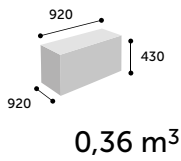
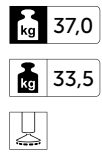

**S2V**

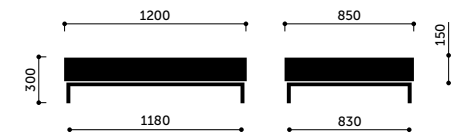
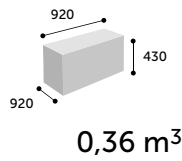
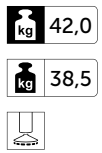

**S1H**

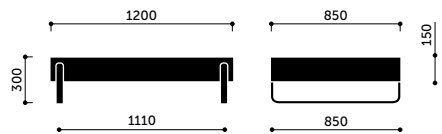
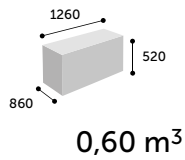
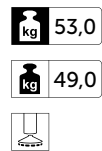

**S1V**

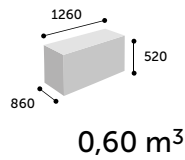
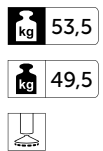

## Noor

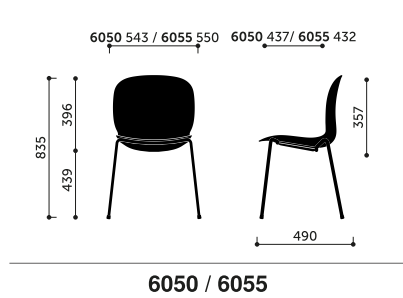

**6050 / 6055**

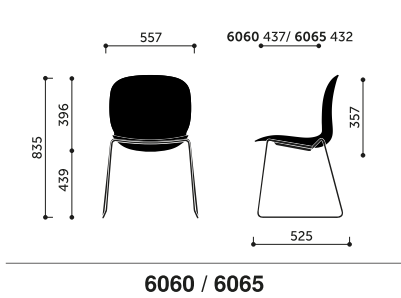

**6060 / 6065**

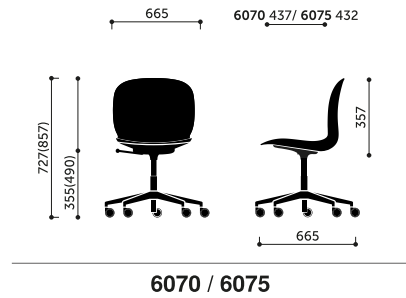

**6070 / 6075**

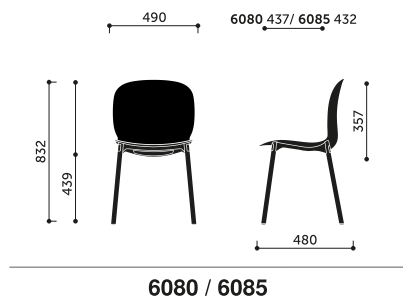

**6080 / 6085**

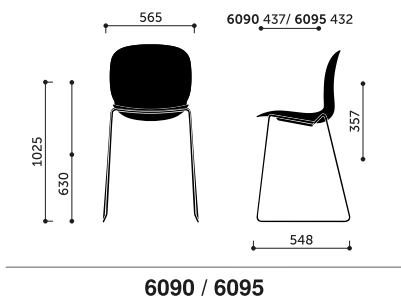

**6090 / 6095**

# Technical details

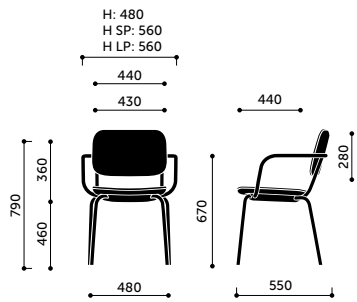

**H / H SP / H LP**

H 7,0

H SP 8,0

H LP 8,5

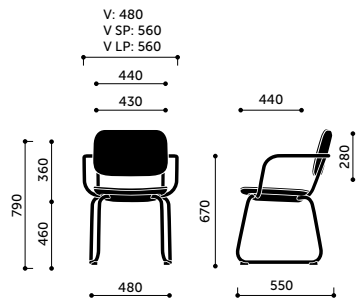

**V / V SP / V LP**

V 8,0

V SP 8,5

V LP 9,0

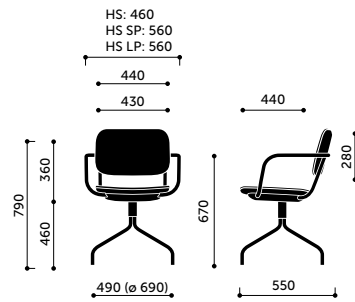

**HS / HS SP / HS LP**

HS 9,5

HS SP 10,0

HS LP 10,5

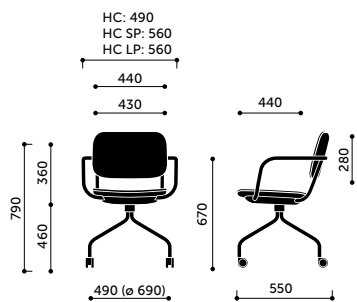

**HC / HC SP / HC LP**

HC 9,0

HC SP 10,0

HC LP 10,5

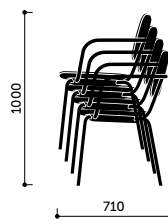

**stacking H / H SP / H LP / V / V SP**

4

# Technical details

## Nu

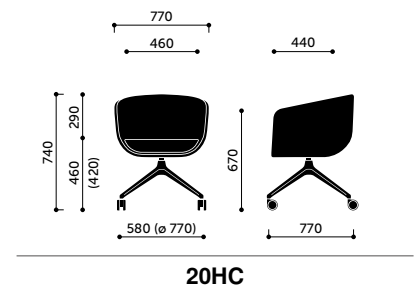
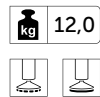
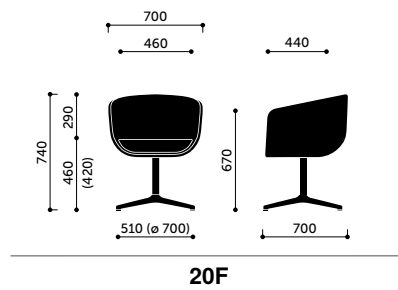
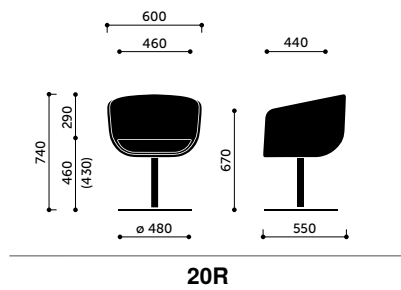
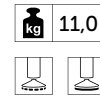
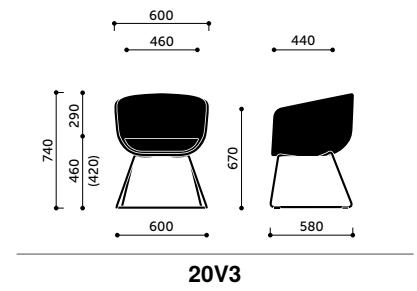
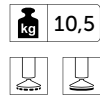
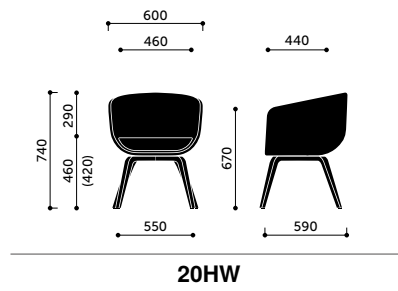
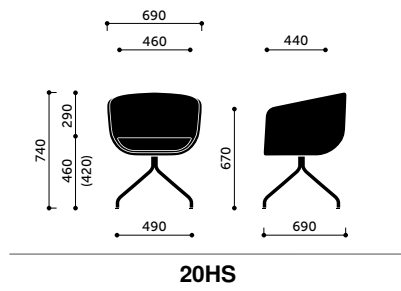

## October

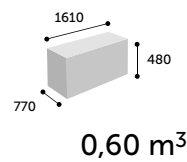
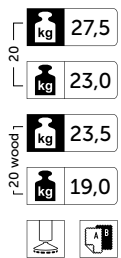
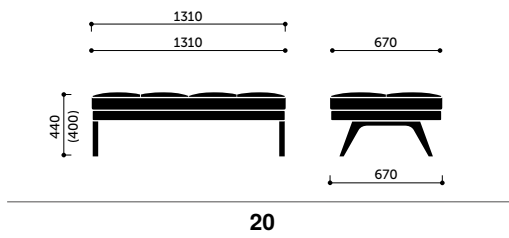
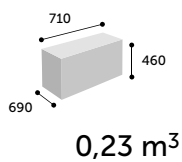
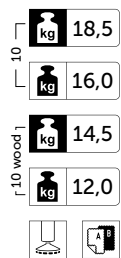
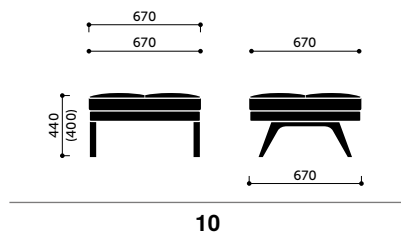

# Technical details

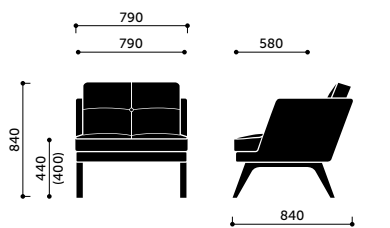

11

11	kg 38,5	900	800	900	0,64 m <sup>3</sup>
	kg 34,0				
11 wood	kg 34,5				
	kg 30,0				

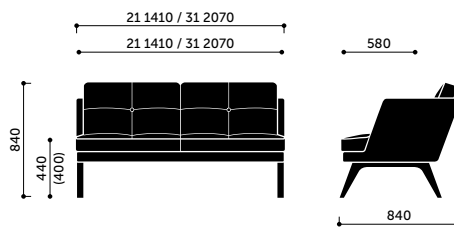

21 / 31

21	kg 49,5	1750	810	960	1,40 m <sup>3</sup>
	kg 42,0				
31	kg 64,5	2330	690	980	1,58 m <sup>3</sup>
	kg 56,0				
21 wood	kg 45,5				
	kg 38,0				
31 wood	kg 60,5				
	kg 52,0				

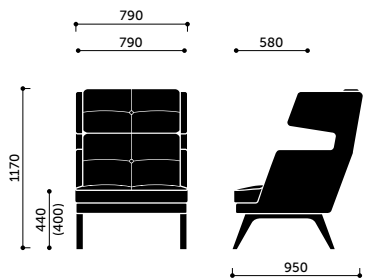

12

12	kg 49,0	970	1210	980	1,15 m <sup>3</sup>
	kg 41,0				
12 wood	kg 45,0				
	kg 37,0				

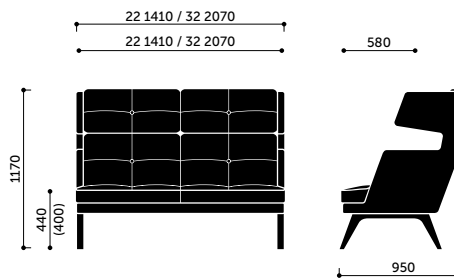

22 / 32

22	kg 70,5	1620	1210	980	1,90 m <sup>3</sup>
	kg 59,0				
32	kg 89,0	2300	1210	980	2,70 m <sup>3</sup>
	kg 77,5				
22 wood	kg 66,5				
	kg 55,0				
32 wood	kg 85,0				
	kg 73,5				

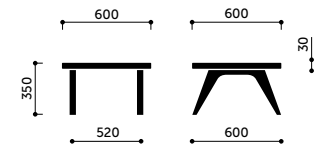

S2

S2	kg 15,0	610	360	610	0,13 m <sup>3</sup>
	kg 13,0				
S2 wood	kg 11,0				
	kg 9,0				

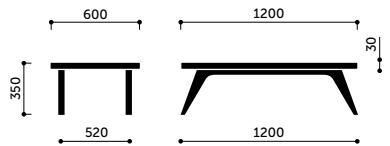

S1

S1	kg 27,5	1250	400	650	0,33 m <sup>3</sup>
	kg 24,5				
S1 wood	kg 21,5				
	kg 18,5				

# Technical details

## Revo

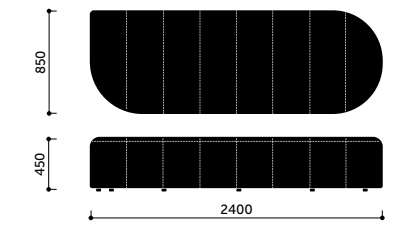

**SW240**

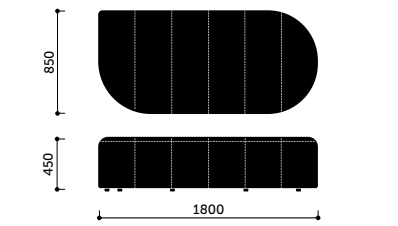

**SW180**

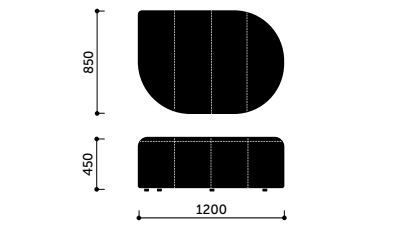

**SW120**

**50,5**  
**42,0**  
**930**

**1,10 m<sup>3</sup>**

**40,5**  
**34,0**  
**930**

**0,85 m<sup>3</sup>**

**27,0**  
**21,0**  
**930**

**0,60 m<sup>3</sup>**

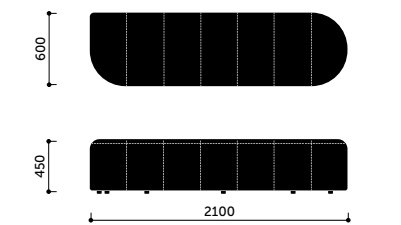

**SN210**

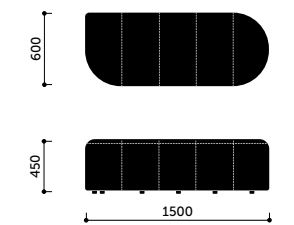

**SN150**

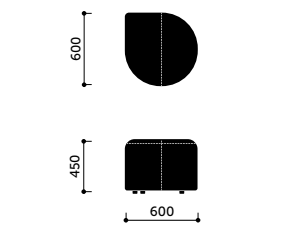

**P60**

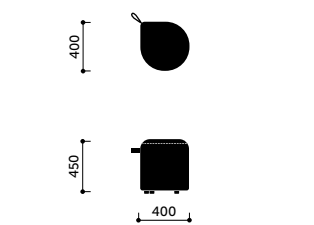

**P40**

**34,0**  
**27,0**  
**680**

**0,70 m<sup>3</sup>**

**23,5**  
**19,0**  
**780**

**0,60 m<sup>3</sup>**

**8,5**  
**6,5**  
**720**

**0,25m<sup>3</sup>**

**4,5**  
**3,5**  
**490**

**0,12m<sup>3</sup>**

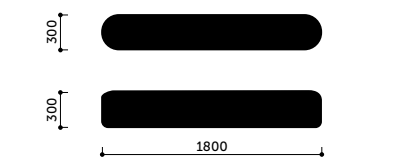

**B180**

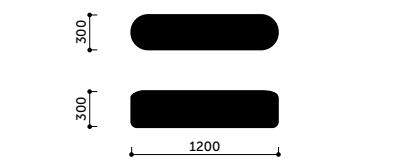

**B120**

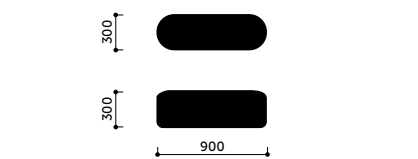

**B90**

**14,0**  
**10,0**  
**560**

**0,35 m<sup>3</sup>**

**11,5**  
**8,0**  
**560**

**0,25 m<sup>3</sup>**

**8,0**  
**5,0**  
**560**

**0,18m<sup>3</sup>**

## Technical details

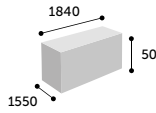
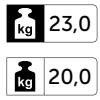
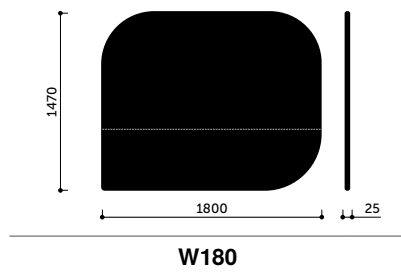

0,13 m<sup>3</sup>

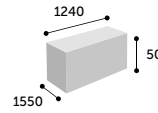
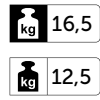
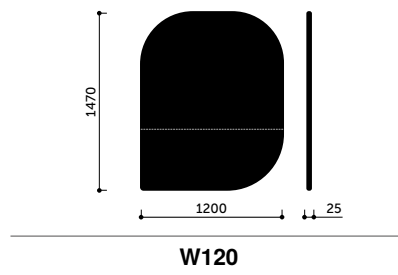

0,09m<sup>3</sup>

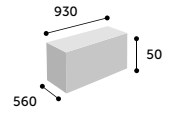
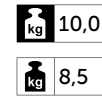
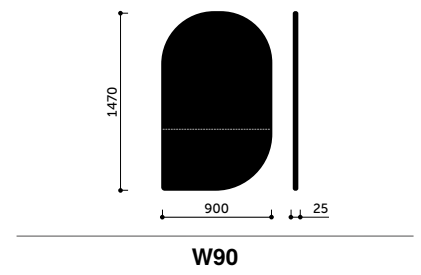

0,03 m<sup>3</sup>

## Revo Tables

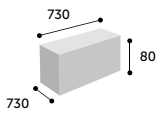
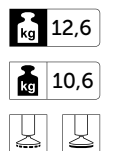
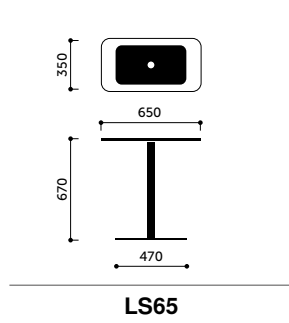

0,04 m<sup>3</sup>

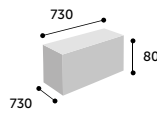
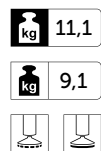
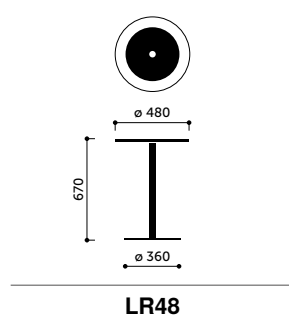

0,04 m<sup>3</sup>

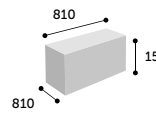
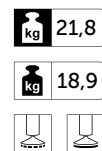
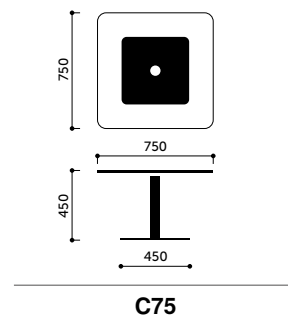

0,10 m<sup>3</sup>

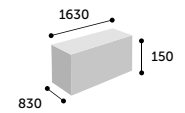
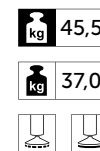
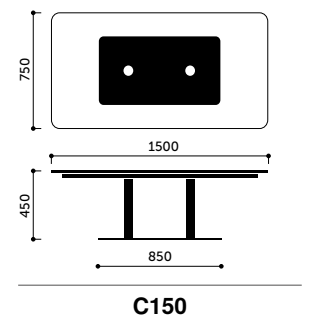

0,20 m<sup>3</sup>

# Technical details

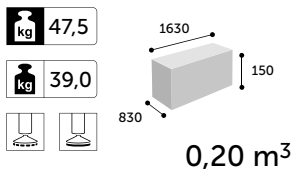
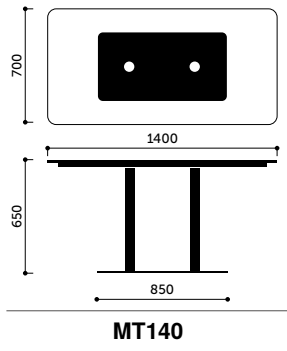
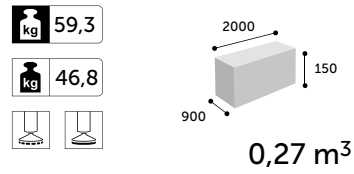
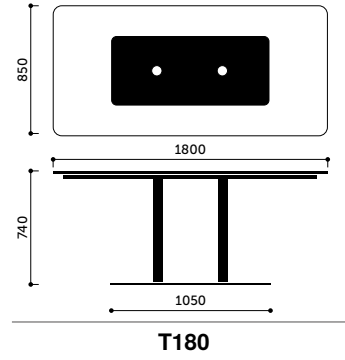
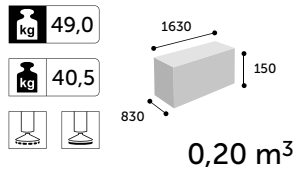
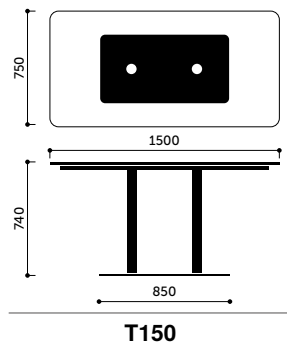
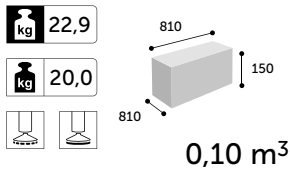
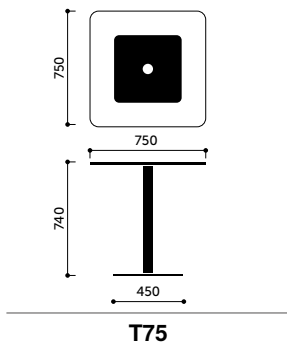

## Seven

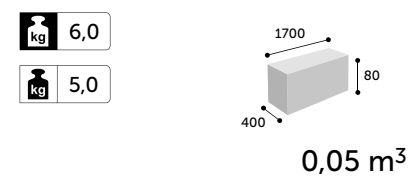
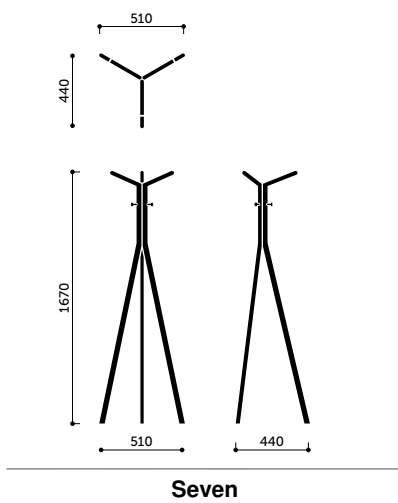

# Technical details

## Snap

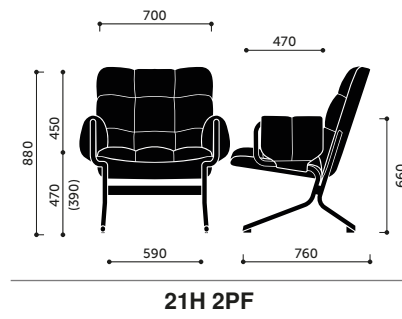
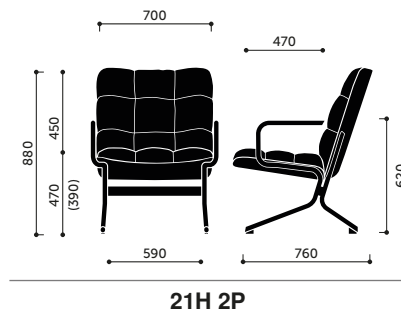
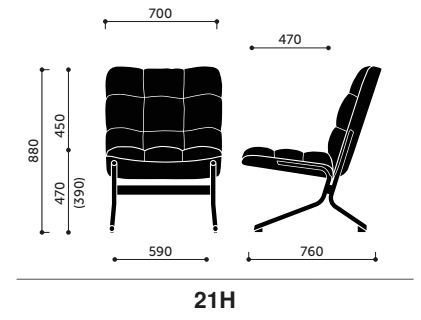
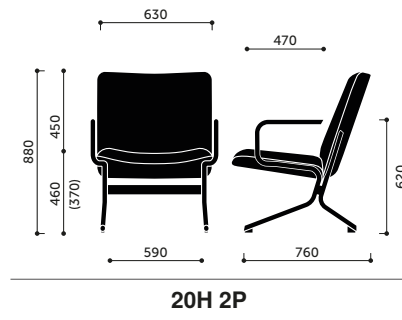
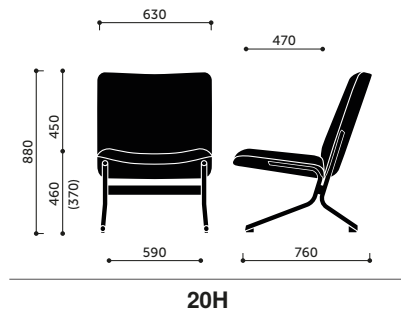

## SoftBox

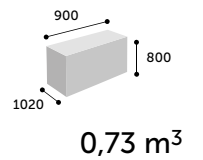
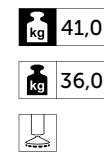
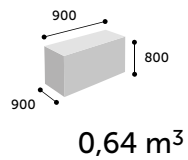
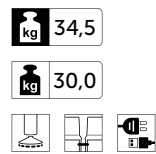
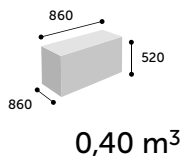
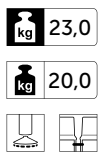
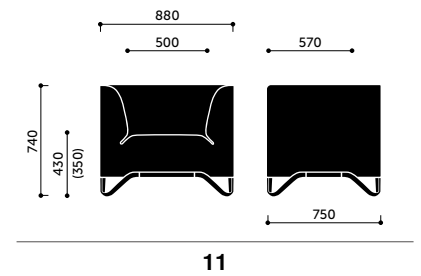
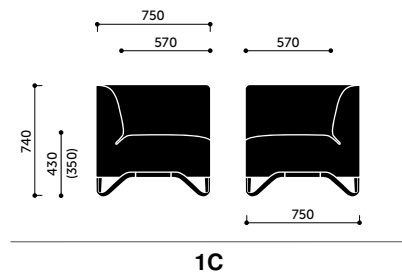
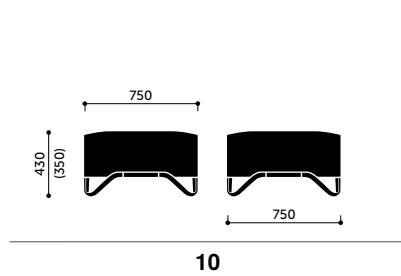



# Technical details

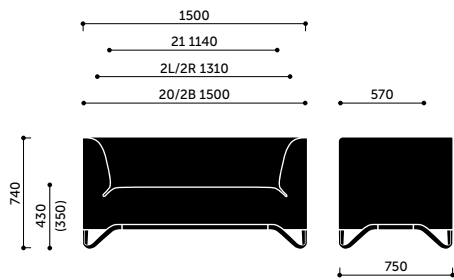

**20 / 2B / 2L / 2R / 21**

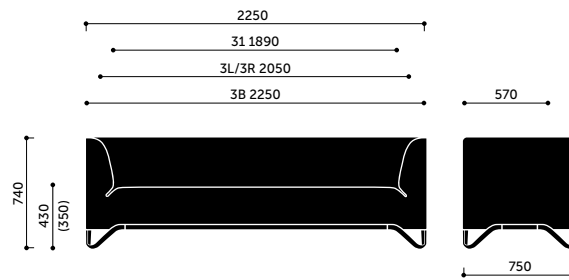

**3B / 3L / 3R / 31**

20	33,5		 <b>0,74 m<sup>3</sup></b>
	29,0		
2B	55,0		 <b>1,20 m<sup>3</sup></b>
	48,0		
2L/2R	58,0		
	51,0		
21	61,0		
	54,0		

3B	79,0		 <b>1,75 m<sup>3</sup></b>
	70,0		
3L/3R	82,0		
	73,0		
31	85,0		
	76,0		

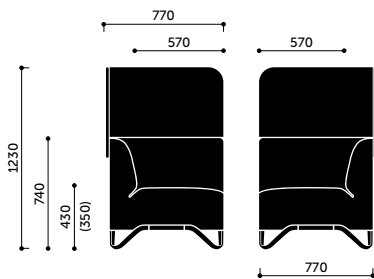

**1CW**

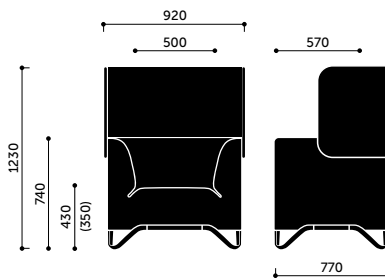

**11W**

42,5	 <b>0,64 m<sup>3</sup></b>
38,0	

52,0	 <b>0,73 m<sup>3</sup></b>
47,0	

# Technical details

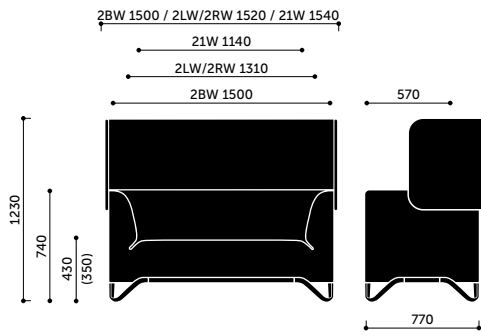

**2BW / 2LW / 2RW / 21W**

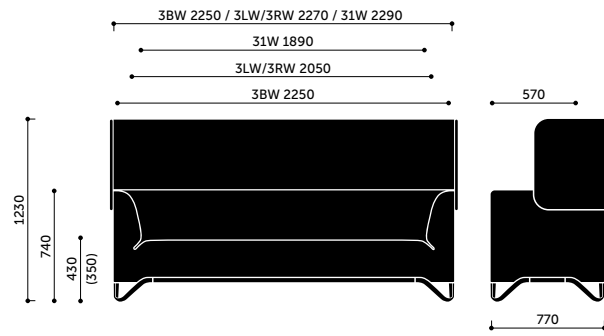

**3BW / 3LW / 3RW / 31W**

2BW	63,5			<b>1,20 m<sup>3</sup></b>
	56,5			
2LW/2RW	68,5			
	61,5			
21W	75,5			
	68,5			

3BW	92,5			<b>1,75 m<sup>3</sup></b>
	83,5			
3LW/3RW	98,0			
	89,0			
31W	102,5			
	93,5			

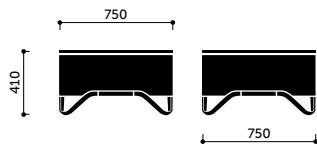

**S2**

27,0		<b>0,40 m<sup>3</sup></b>
24,0		

## Sorriso

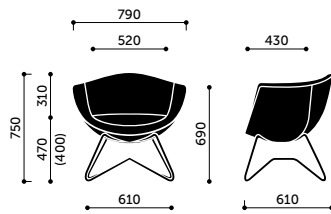

**10V**

17,5		<b>0,53 m<sup>3</sup></b>
13,5		

# Technical details

## Standard Folding Table

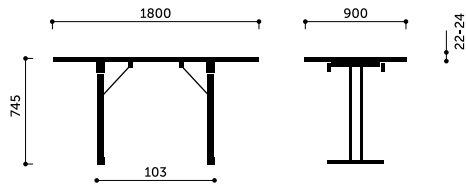

**Standard Folding Table 4680-10**

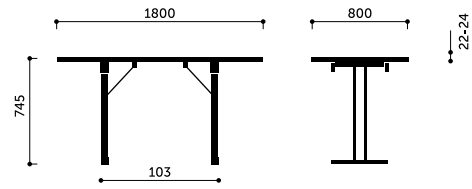

**Standard Folding Table 4680-22**

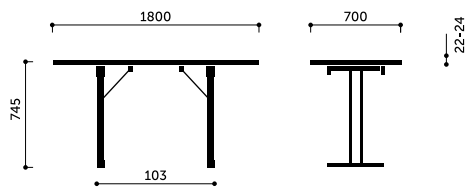

**Standard Folding Table 4680-36**

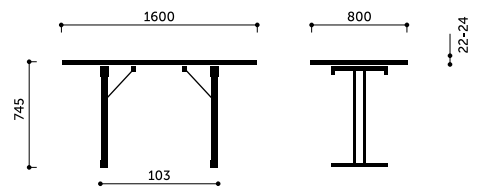

**Standard Folding Table 4680-24**

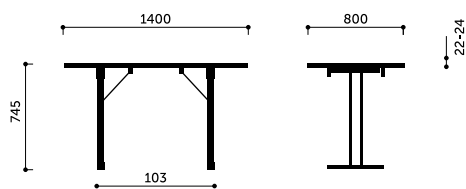

**Standard Folding Table 4680-25**

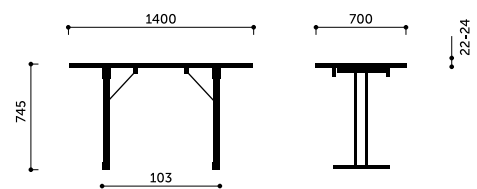

**Standard Folding Table 4680-38**

# Technical details

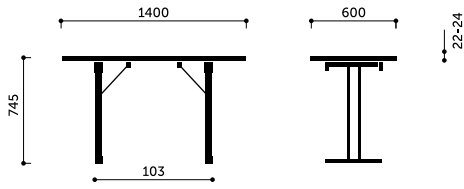

**Standard Folding Table 4680-52**

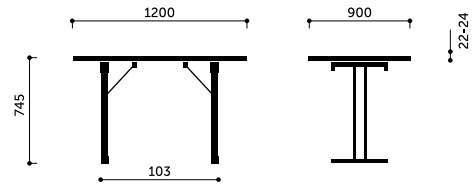

**Standard Folding Table 4680-15**

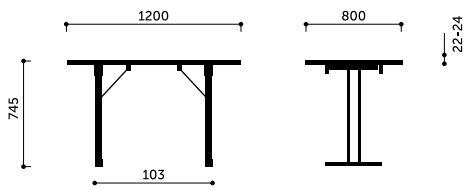

**Standard Folding Table 4680-27**

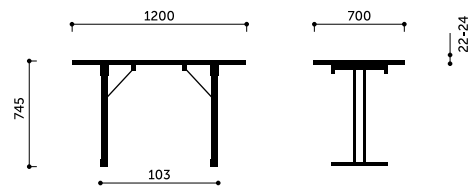

**Standard Folding Table 4680-39**

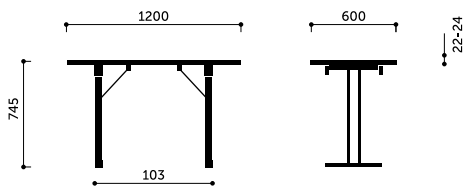

**Standard Folding Table 4680-54**

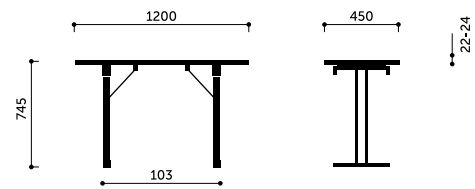

**Standard Folding Table 4680-90**

# Technical details

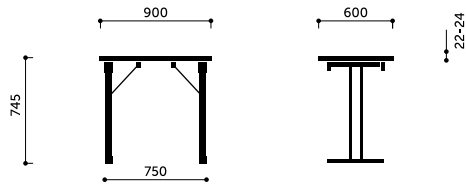

**Standard Folding Table 4680-58**

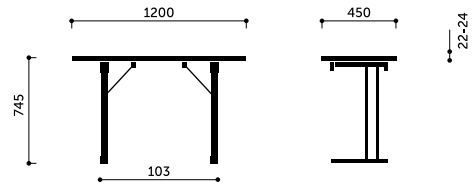

**Standard Folding Table 4688-90**

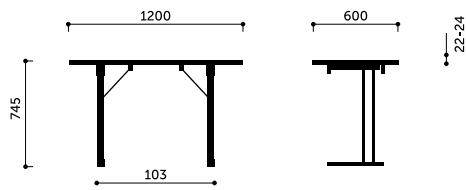

**Standard Folding Table 4688-54**

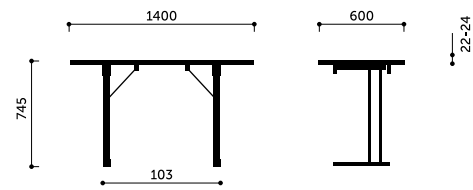

**Standard Folding Table 4688-52**

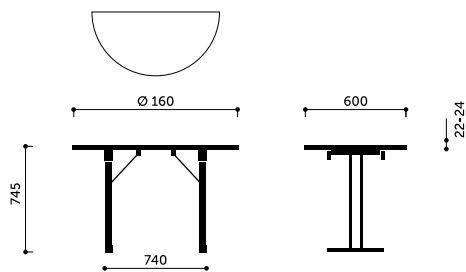

**Standard Folding Table 4681-45**

# Technical details

## Tables

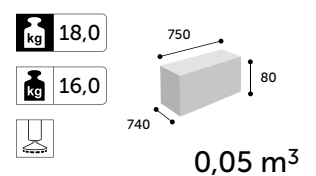
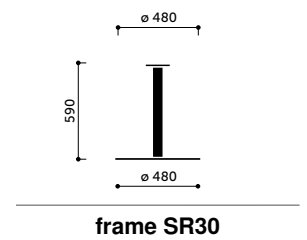
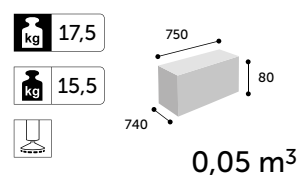
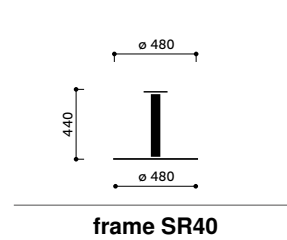
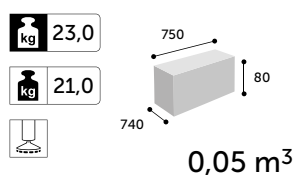
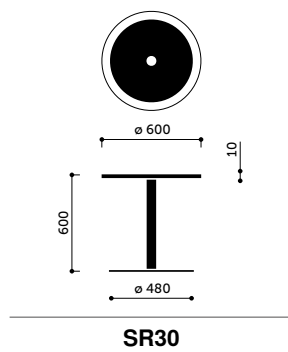
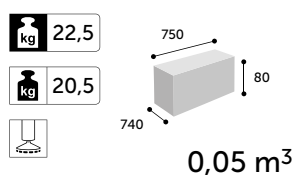
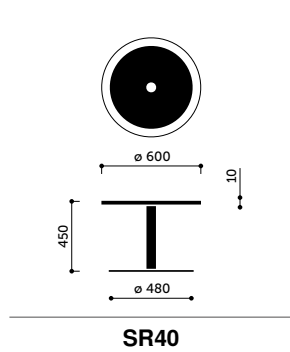
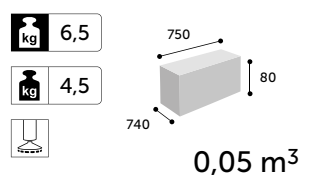
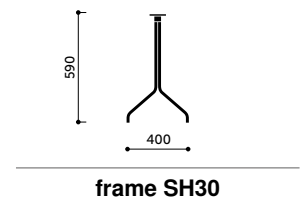
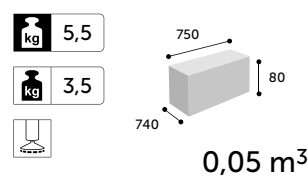
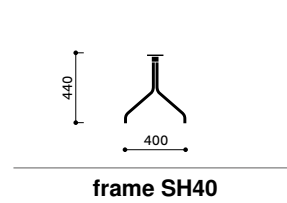
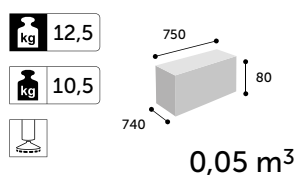
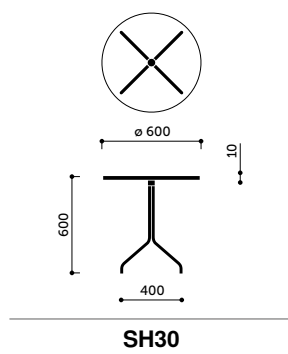
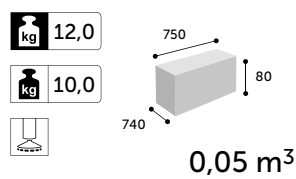
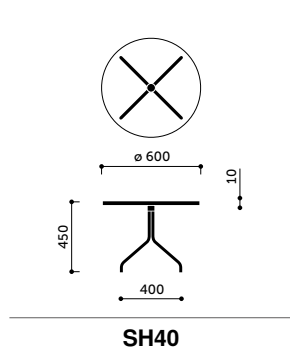
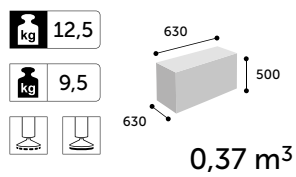
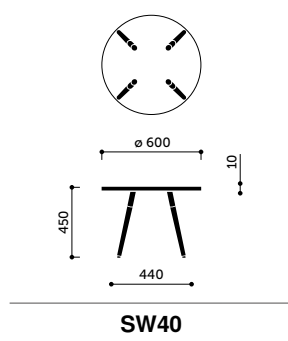
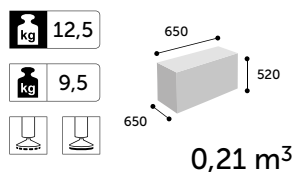
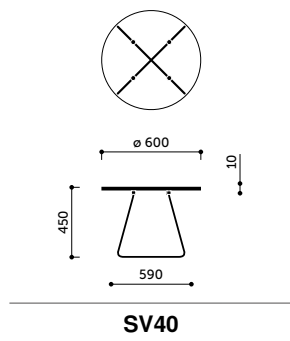

# Technical details

## Trillo<sup>Pro</sup>

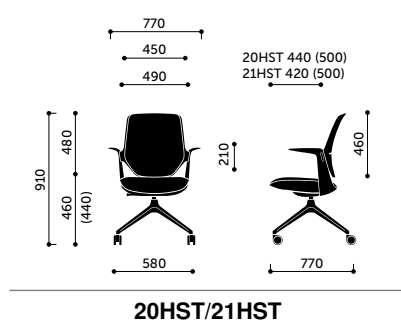

20HST		12,5
21HST		13,0

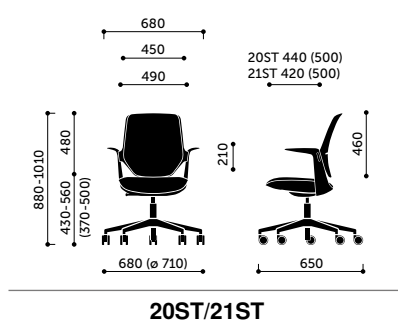

20ST		11,5
21ST		12,0

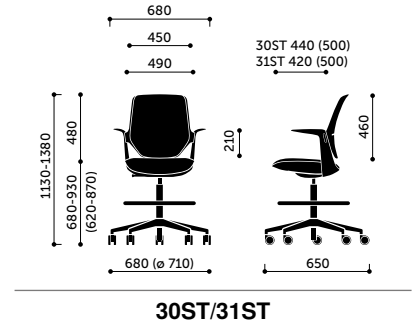

30ST		14,5
31ST		14,0

## Trillo<sup>Pro</sup>

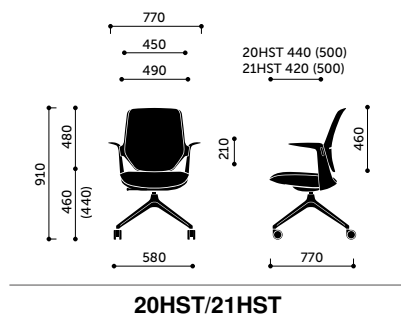

20HST		12,5
21HST		13,0

# Technical details

## u-Connect

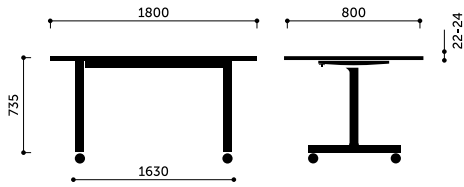

**u-Connect 3490-22**

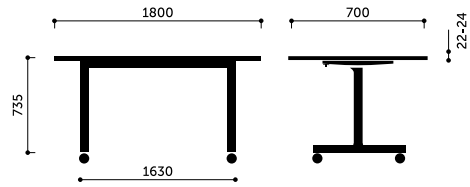

**u-Connect 3490-36**

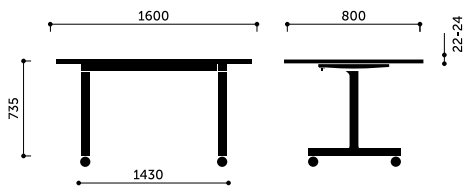

**u-Connect 3490-24**

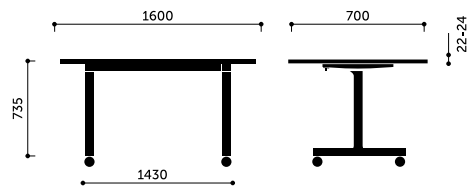

**u-Connect 3490-37**

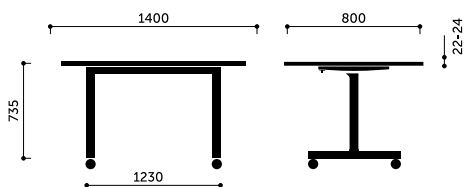

**u-Connect 3490-25**

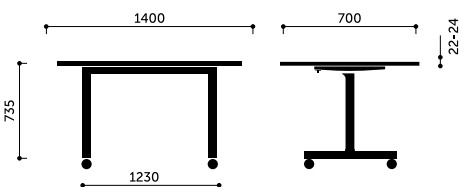

**u-Connect 3490-38**



# Technical details

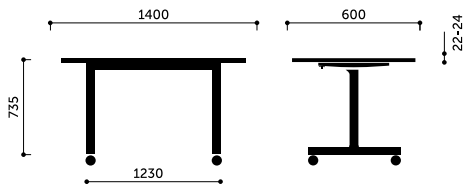

**u-Connect 3490-52**

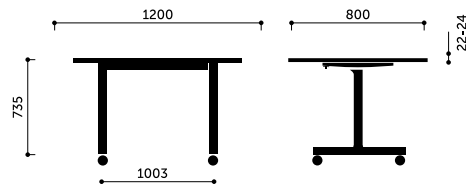

**u-Connect 3490-27**

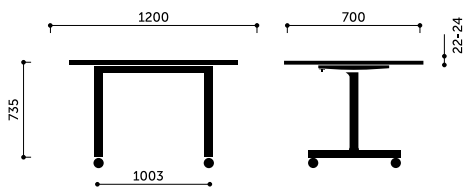

**u-Connect 3490-39**

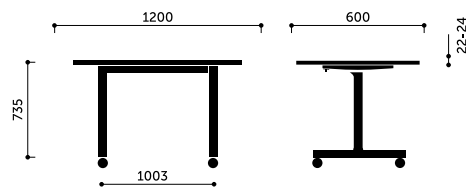

**u-Connect 3490-54**

## Vancouver Lite

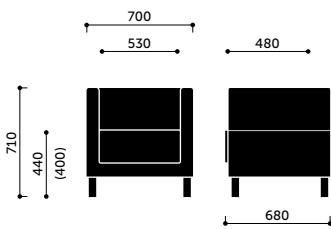

**VL1 H / VL1 V**

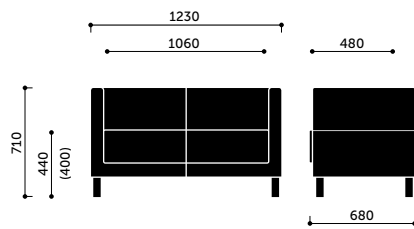

**VL2 H / VL2 V**

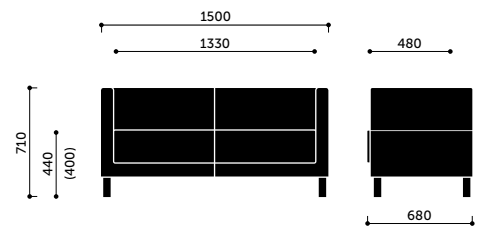

**VL2,5 H / VL2,5 V**

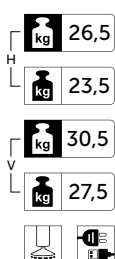

0,43 m<sup>3</sup>

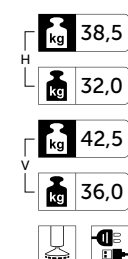

0,90 m<sup>3</sup>

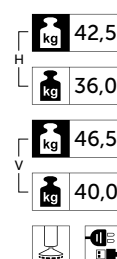

0,92 m<sup>3</sup>

# Technical details

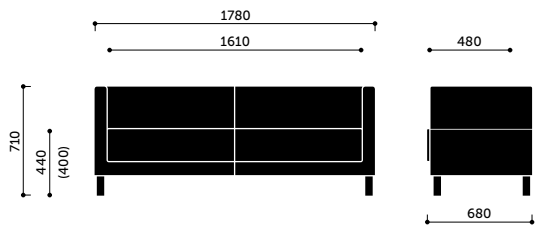

**VL3 H / VL3 V**

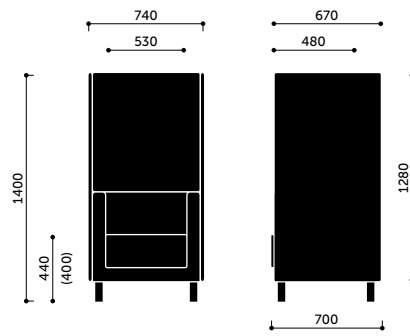

**VL1 HW / VL1 VW + VL W1**

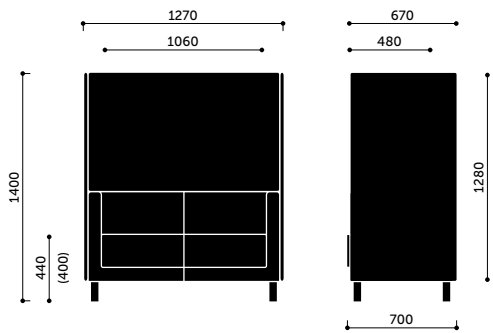
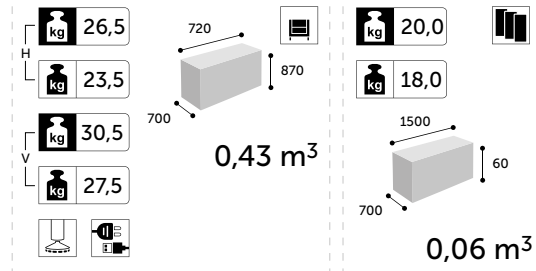
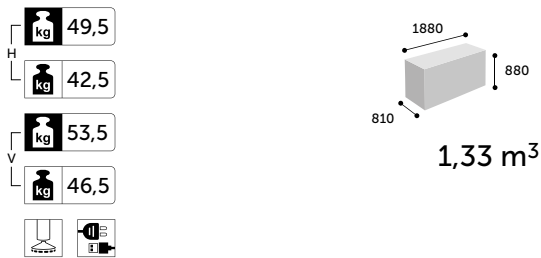

**VL2 HW / VL2 VW + VL W2**

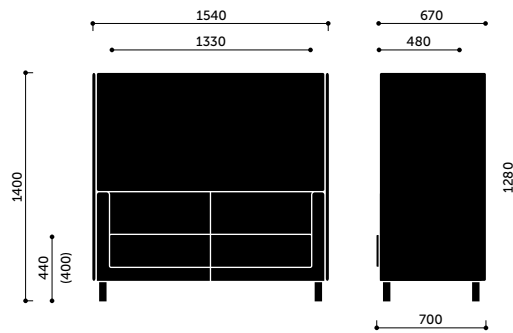

**VL2,5 HW / VL2,5 VW + VL W2,5**

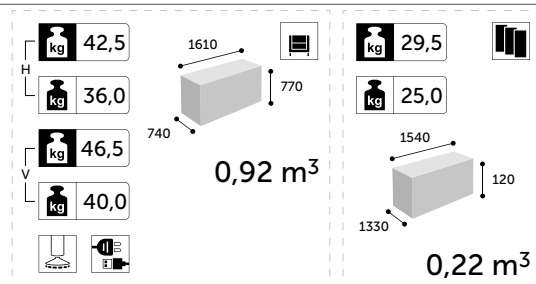
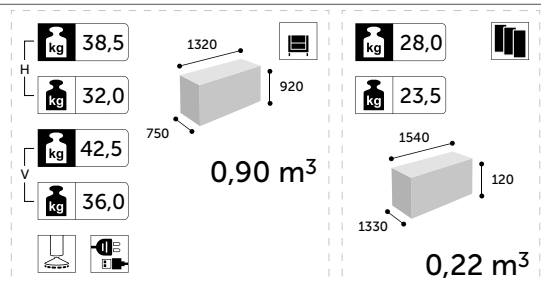

# Technical details

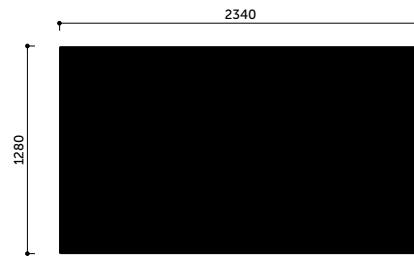
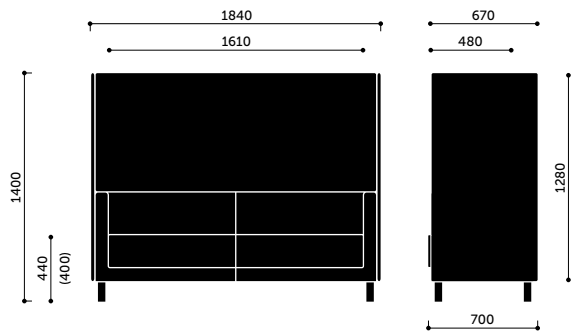

**VL3 HW / VL3 VW + VL W3**

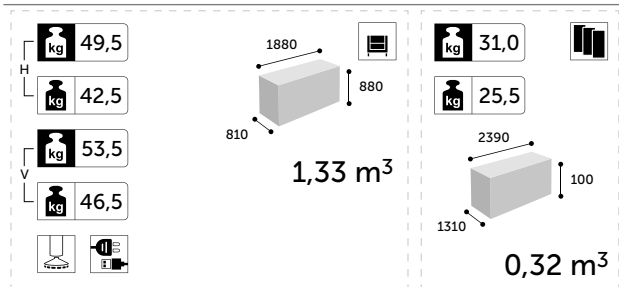

**VL SW / VL SW HA**

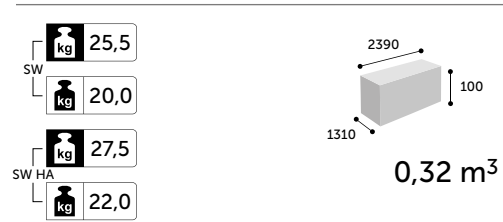

## Vancouver Oto

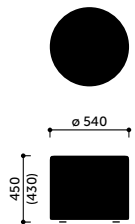

**VOR1**

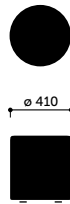
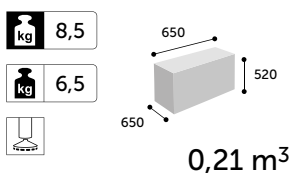

**VOR2**

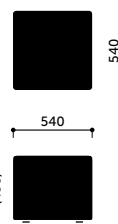
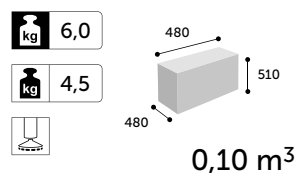

**VOS1**

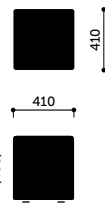
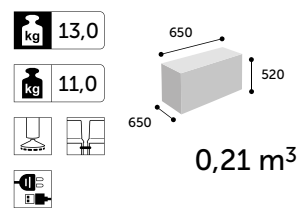

**VOS2**

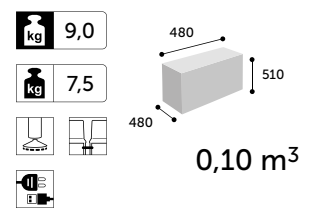

# Technical details

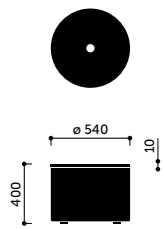

**VOR1B**

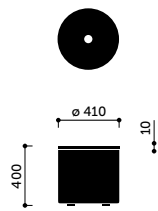

**VOR2B**

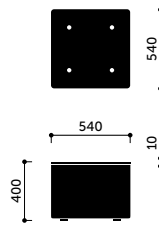

**VOS1B**

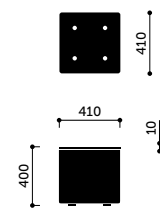

**VOS2B**

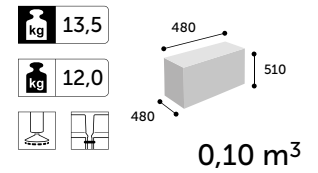
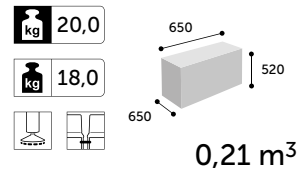
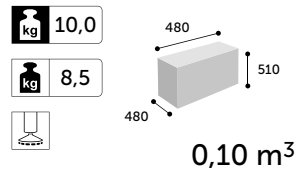
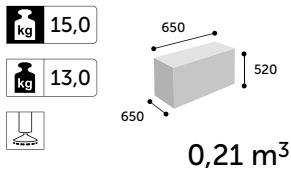

## Wall In

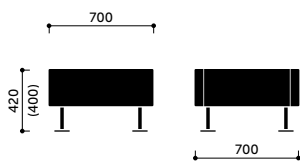

**10 / 11 / 12 / 13**

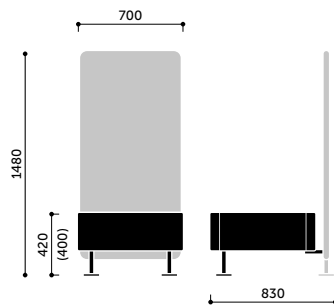

**11 + W11**

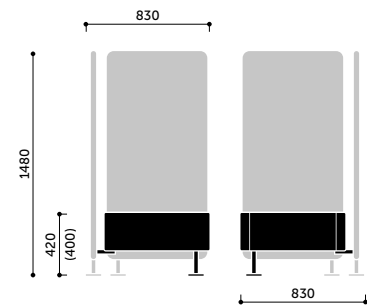

**12 + 2xW11 (version I)**

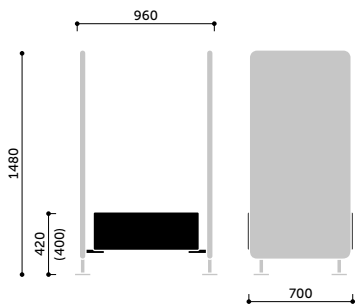
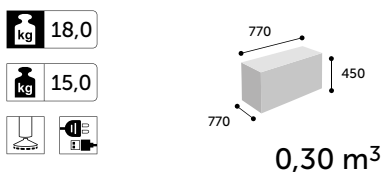

**12 + 2xW11 (version II)**

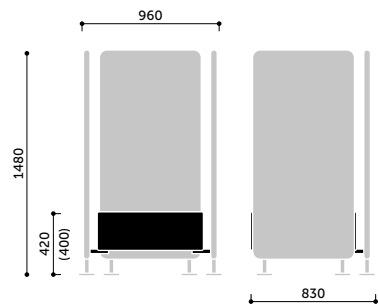

**13 + 3xW11**

# Technical details

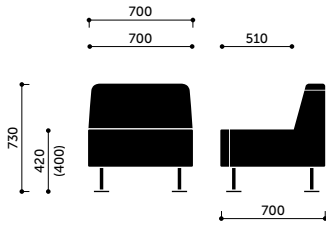

20 / 21 / 22 / 23

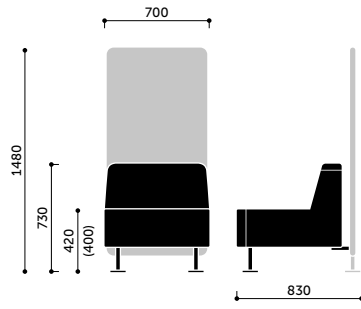

21 + W11

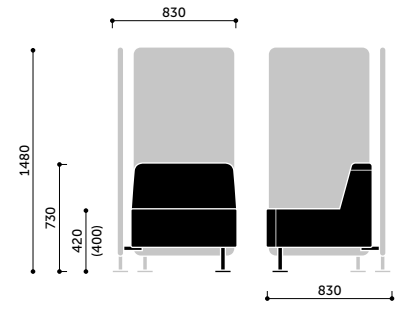

22 + 2xW11 (version I)

**kg** 23,5

**kg** 19,0

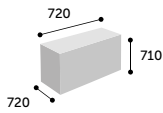

0,35 m<sup>3</sup>

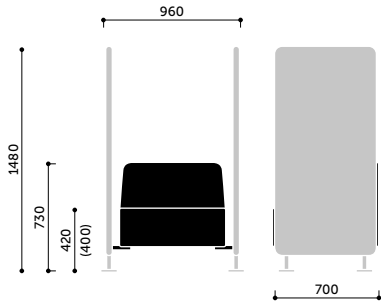

22 + 2xW11 (version II)

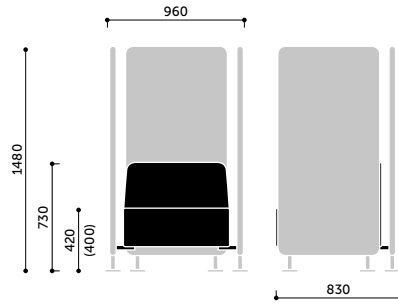

23 + 3xW11

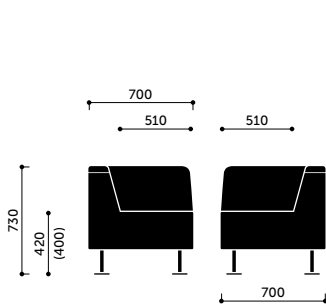

30 / 31 / 32

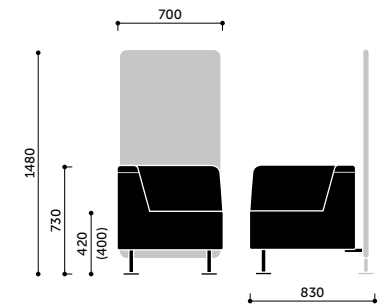

31

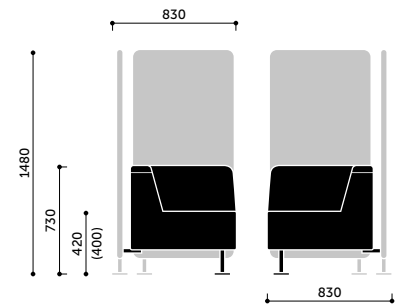

32

**kg** 24,5

**kg** 20,0

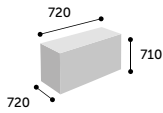

0,35 m<sup>3</sup>

# Technical details

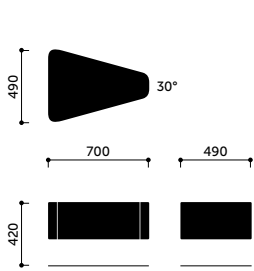

**C1**

kg 8,5  
kg 7,0

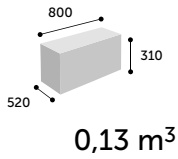

0,13 m<sup>3</sup>

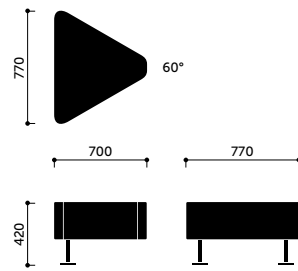

**C2**

kg 11,5  
kg 9,0  

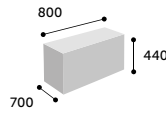

0,25 m<sup>3</sup>

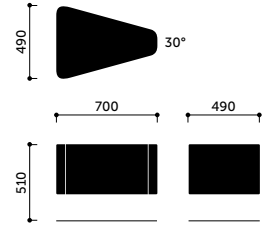

**P1**

kg 12,0  
kg 9,5

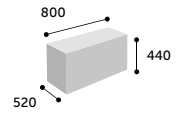

0,20 m<sup>3</sup>

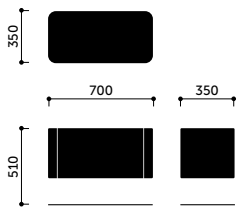

**P3**

kg 12,5  
kg 10,0

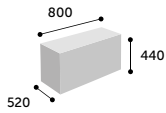

0,20 m<sup>3</sup>

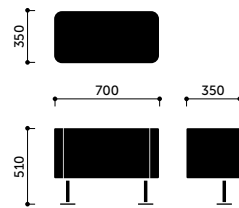

**P4**

kg 13,5  
kg 11,0  

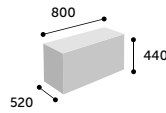

0,20 m<sup>3</sup>

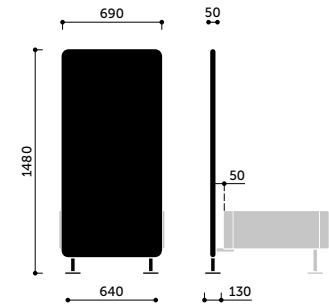

**W11 / W12**

kg 11,5  
kg 9,5  

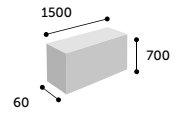

0,06 m<sup>3</sup>

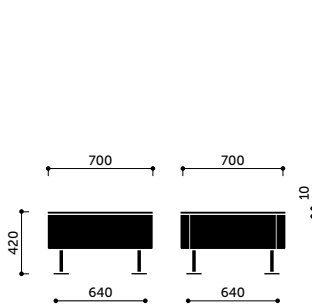

**B**

kg 28,5  
kg 25,5  

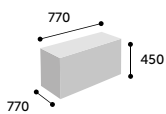

0,30 m<sup>3</sup>

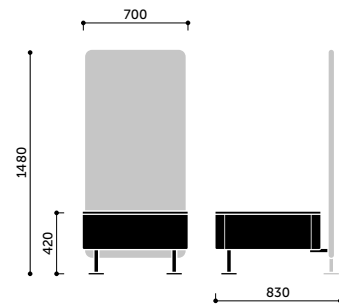

**BW1 + W11**

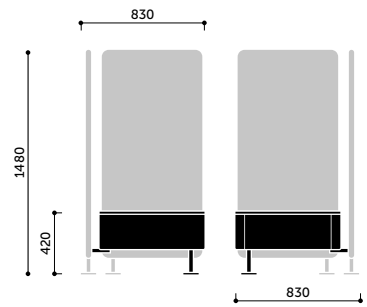

**BW2 + 2xW11**

# Technical details

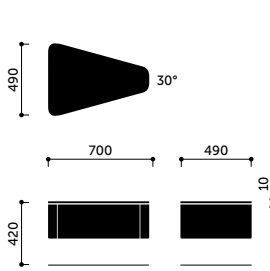

**B1**

**kg** 14,5  
**kg** 13,0

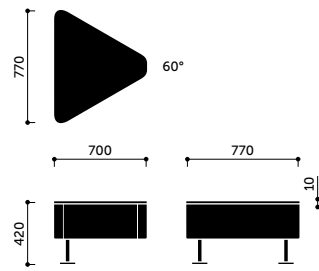
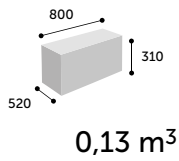

**B2**

**kg** 20,5  
**kg** 18,0

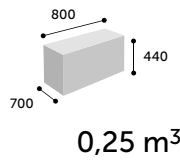

## Zoo

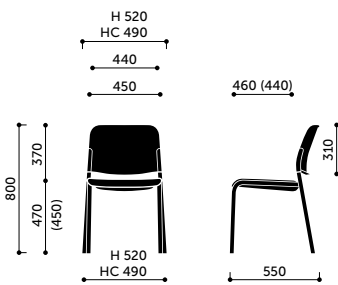

**522H / 522HC**

**H** **kg** 7,0  
**HC** **kg** 7,5

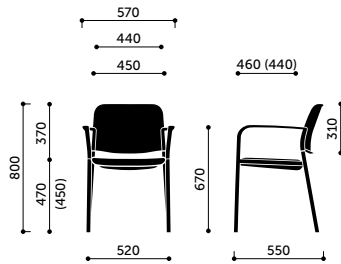

**522H 2P / 522HC 2P**

**H 2P** **kg** 8,0  
**HC 2P** **kg** 8,5

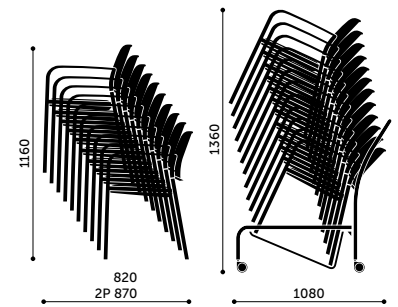

**stacking 522H**

**H** 10  
**H** 12

**H 2P** 10  
**H 2P** 10

**H 2PB** 5  
**H 2PB** 5

# Technical details

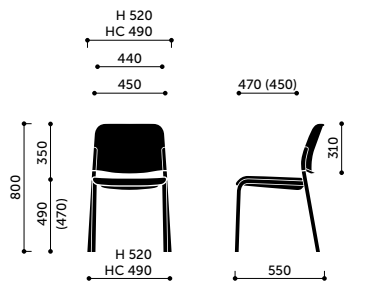

**502H / 502HC**

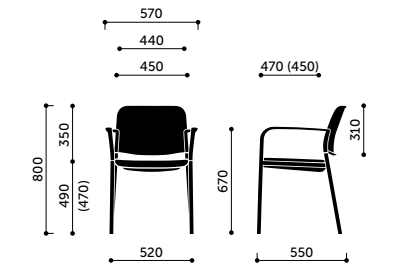

**502H 2P / 502HC 2P**

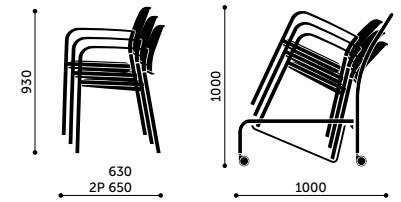

**stacking 502H**

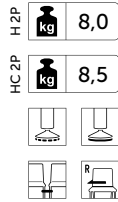
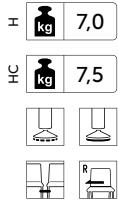

\* chairs upholstered in Valencia: 3 pcs.

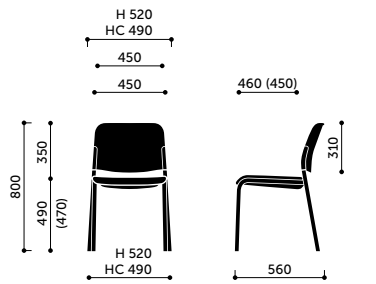

**500H / 500HC**

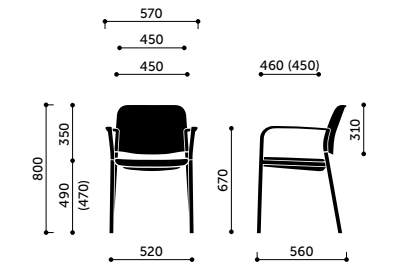

**500H 2P / 500HC 2P**

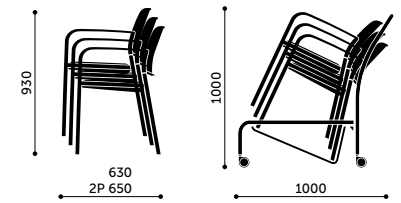

**stacking 500H**

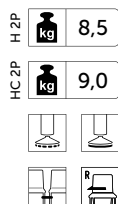
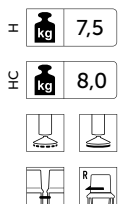

\* chairs upholstered in Valencia: 3 pcs.



# Castors / glides









Castors / glides	Models	Type	Castors / glides	Models	Type
	Ellie <sup>Pro</sup> , Noor, Trillo <sup>Pro</sup>	soft / hard (ø 65 mm)		Com V	felt / teflon
	Trillo <sup>Pro</sup> 30ST/31ST	soft / hard (ø 65 mm)		Chic H	felt / teflon
	Acos <sup>Pro</sup> 30VN	felt / teflon		Chic 20F, Fan 10F, Nu 20F	felt / teflon
	Acos <sup>Pro</sup> 30H	felt / teflon		Chic 20HW, Nu 20HW	felt / teflon
	Ariz - without armrests	felt / teflon		Ellie <sup>Pro</sup> 10HW, Ellie <sup>Pro</sup> 20HW	felt / teflon
	Ariz - with armrests	felt / teflon		Chic Lounge V3, Nu 20V3	felt / teflon
	Bit H	felt / teflon		Ellie <sup>Pro</sup> 10V3, Ellie <sup>Pro</sup> 20V3	felt / teflon
	Bit V, Zoo H	felt / teflon		Ellie <sup>Pro</sup> 10ST, Ellie <sup>Pro</sup> 20ST, Ellie <sup>Pro</sup> 10HST, Ellie <sup>Pro</sup> 20HST, Trillo <sup>Pro</sup> 20, Trillo <sup>Pro</sup> 21, Nu HC	teflon (ø 50 mm)
	Com H	felt / teflon		Fan 10H, Fan 10HS, Nu 20HS	felt / teflon
	Com V1	felt / teflon		Fan 10HW	felt / teflon
	Com V2	felt / teflon		Fan 10V, Fan 20V	felt / teflon
	Ana	felt / hard			

## Castors / glides





Castors / glides	Models	Type
	Fan 10HC, Fan 10Z, Fan 10E, Nu 20HC	Universal (ø 65 mm)
	Com HC, Normo HC	Universal (ø 55 mm)
	Fan 10Z, Fan 10E	teflon
	Sorriso 10V	felt / teflon
	Noor 6090/6095	felt / hard
	Noor 6060/6065	felt / hard
	Noor 6050/6055	felt / hard
	Noor 6080/6085	felt / hard

Castors are equipped with a brake that prevents the chair from "moving away" without a load.  
In models LightUp 330ST/350ST and Trillo<sup>Pro</sup> 30ST/31ST castors are equipped with a reverse brake that prevents the chair from "moving away" with a load.

# Bases

Base	Applied to the models	Colour	Type of material	Diameter (mm)
	Ellie <sup>Pro</sup> 10HST, Ellie <sup>Pro</sup> 20HST, Trillo <sup>Pro</sup> 20HST, Trillo <sup>Pro</sup> 21HST, Nu HC	black	aluminium powder coated aluminum	770
	Ellie <sup>Pro</sup> 10HST, Ellie <sup>Pro</sup> 20HST, Trillo <sup>Pro</sup> 20HST, Trillo <sup>Pro</sup> 21HST, Nu HC	white	powder coated aluminum	770
	Ellie <sup>Pro</sup> 10HST, Ellie <sup>Pro</sup> 20HST, Trillo <sup>Pro</sup> 20HST, Trillo <sup>Pro</sup> 21HST, Nu HC	graphite	powder coated aluminum	770
	Ellie <sup>Pro</sup> 10HST, Ellie <sup>Pro</sup> 20HST, Trillo <sup>Pro</sup> 20HST, Trillo <sup>Pro</sup> 21HST, Nu HC	polished aluminum	aluminium	770
	Ellie <sup>Pro</sup> 10ST, Ellie <sup>Pro</sup> 20ST	black	plastic - polyamide	710
	Ellie <sup>Pro</sup> 10ST, Ellie <sup>Pro</sup> 20ST	light grey	plastic - polyamide	710
	Noor 6070, Noor 6075	polished aluminum	aluminium	665
	Noor 6070, Noor 6075	black	aluminium	665
	Noor 6070, Noor 6075	white	aluminium	665

# Bases

Base	Applied to the models	Colour	Type of material	Diameter (mm)
	Fan	black	plastic - polyamide	720
	Fan	MetallicPro	powder coated aluminum	720
	Fan	polished aluminum	aluminum	720
	Sorriso 10F	polished aluminum	aluminium	760
	Fan 10F, Nu 20F	polished aluminum	aluminium	700

# Mechanisms



## Rocker

Fan 10Z

A - Seat height  
B - Tilt angle of the backrest and the seat

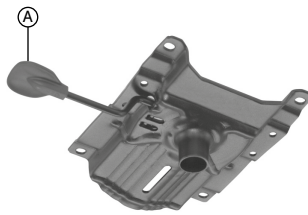

## Economic

Fan 10E

A - Seat height

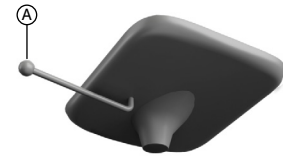

## Economic

Noor 6070/6075

A - Seat height

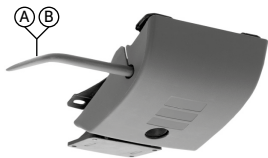

## Synchro Self\*

Trillo<sup>Pro</sup>, Ellie<sup>Pro</sup>

A - Seat height  
B - Tilt angle of the backrest and the seat



## Synchro Self\*

Trillo<sup>Pro</sup>, Ellie<sup>Pro</sup>

A - Tilt angle of the backrest and the seat

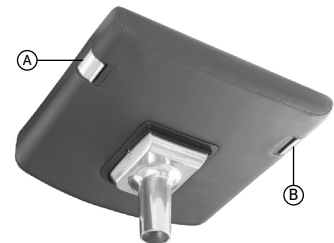

## Rocker

MyTurn 10FZ, 20FZ

A - Seat height (only in Z models)  
B - Tilt angle of the backrest and the seat

The Synchro mechanisms used in Profim products are equipped with Anti-Shock system after releasing the mechanism, the back does not hit the sitting person, but remains in the previous position. The Synchro mechanism is activated only when the person leans on the backrest again.

# Linking parts

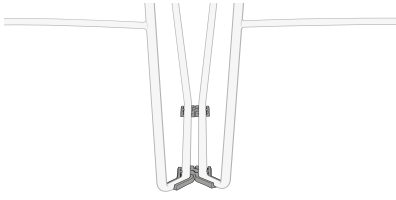

## Linking part Ariz

Price - no extra charge.

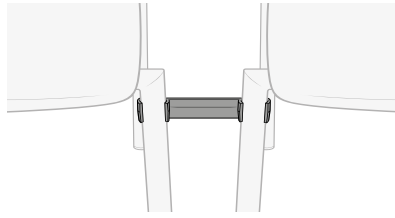

## Universal FIXED 1 Linking part

Available in models without armrests: Bit.

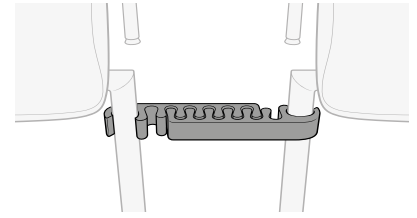

## Universal ADJUSTABLE Linking part

Available in Bit without armrests.  
Available in Com.

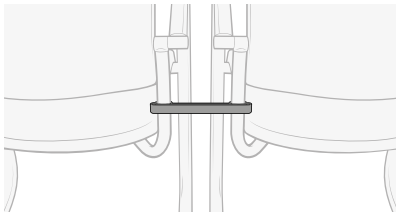

## Universal FIXED 2 Linking part

Available in models: Acos<sup>PRO</sup>.

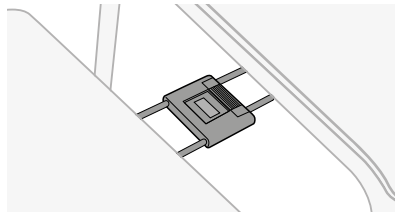

## Linking part Com, Zoo

Available in 4-legged Com and Zoo.

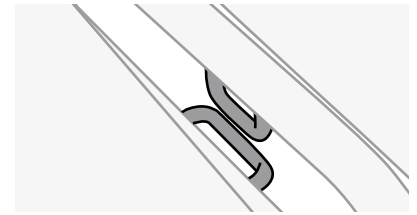

## Linking part Ana

Available in Ana.

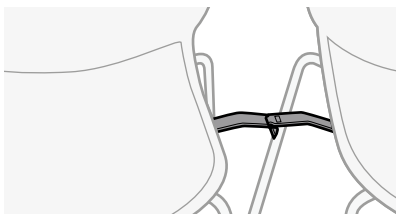

## Linking part Noor

Available in Noor.

# Stacking

	Maximum quantity in stack (pc.)	Maximum quantity in stack on trolley (pc.)
<b>Acos<sup>Pro</sup></b>		
30V	2	-
<b>Ana</b>		
4340	12	-
4340S	10	-
4340SR	7	-
<b>Ariz</b>		
550V, 555V	15	45
550V 2P, 555V 2P	10	45
560V, 560V 2P	5	20
570V, 570V 2P	5	20
575V, 575V 2P	5	20
550CV	2	-
555CV	2	-
560CV	2	-
570CV	2	-
575CV	2	-
<b>Bit</b>		
550H, 550H 2P	5	-
555H, 555H 2P	5	-
560H, 560H 2P	3	-
570H, 570H 2P	3	-
575H, 575H 2P	3	-
550V, 550V 2P	3	-
555V, 555V 2P	3	-
560V, 560V 2P	3	-
570V, 570V 2P	3	-
575V, 575V 2P	3	-
<b>Com</b>		
12H (+2P)	15	15
12H 2PB	5	5
12V1 (+2P)	5	5
12V2	5	5
12V	15	15
22H (+2P)	12	12
22H 2PB	5	5
22V1 (+2P)	5	5
22V2	5	5
22V	12	12
32H (+2P)	12	12
32H 2PB	5	5

	Maximum quantity in stack (pc.)	Maximum quantity in stack on trolley (pc.)
32V1 (+2P)	5	5
32V2	5	5
32V	12	12
42H (+2P)	10	10
42H 2PB	5	5
42V1 (+2P)	5	5
42V2	5	5
42V	10	10
<b>Noor</b>		
4-leg 6050/6055	10	-
4-leg 6050/6055 with armrests	10	-
4-leg 6060/6065	5	-
4-leg 6060/6065 with armrests	5	-
<b>Normo</b>		
H, H LP, H SP	4	-
V, V SP	4	-
<b>Zoo</b>		
522H	10	12
522H 2P	10	10
522H 2PB	5	5
502H, 502H 2P, 502H 2PB	5*	5*
500H, 500H 2P, 500H 2PB	5*	5*

\* Chairs upholstered in Valencia - 3 pcs.

# Glides, table tops, joining in rows

	Joining in rows	Felt glides (for hard surfaces)	Teflon glides (universal)	Left-sided table top	Right-sided table top
Ana	•	•		•	•
Ariz	•	•	•	•	•
Bit	•	•	•		
Chic		•	•		
Chic Lounge		•	•		
Chic Tables		•	•		
Com	•	•	•	•	
Ellie <sup>Pro</sup>		•	•		
Fan		•	•		
Mickey			•		
MyTurn Sofa		•			
Noor	•	•			
Normo		•	•		
Nu		•	•		
October		•			
Revo			•		
Revo Tables		•			
Seven					
SoftBox	•	•			
Sorriso		•	•		
Tables SH/SR/SV/SW		•	•		
Trillo <sup>Pro</sup>			•		
Vancouver Lite		•			
Vancouver Oto	•	•			
Wall In	•	•			
Zoo	•	•	•	•	

Details in additional information on specific models.



# Consumption of fabric and leather

The quantities below are only estimated. The real quantity of fabric- or leather-consumption may vary in accordance to the quantity of pieces on order. Please notice that before we accept any order in customer's own material we need to make sample trials. Please be aware that not every type of fabric/leather is suitable for upholstery. Volume of customer's own material must be agreed each time with Profim sales organization

Column A - Estimated consumption of fabric (roll width: 1,40 m)

Column B - Estimated consumption of leather (m<sup>2</sup>)

	A	B		A	B		A	B
<b>Acos<sup>Pro</sup></b>			<b>Ellie<sup>Pro</sup></b>			<b>Revo</b>		
30H, 30HC, 30V	1,2	1,8	10	2,5	-	P40	1,5	-
			20	2,4	-	P60	2,2	-
<b>Ariz</b>			<b>Fan</b>			SW120		
560, 575	0,6	-	10	1,4	1,9	SW180	3,2	-
570	1,6	-	20	2,4	3,3	SW240	3,9	-
<b>Bit</b>			cushion			SN150		
560, 575	0,6	-		0,5	0,5	SN210	3,3	-
570	1,0	-	<b>Mickey</b>			B90		
580	1,2	-	seating			B120		
			side of the base			B180		
<b>Chic</b>			<b>MyTurn Sofa</b>			W90		
10	2,2	3,5	10	3,8	7,4	W120	3,8	-
20	1,2	1,4	20	6,0	10,0	W180	5,6	-
21	1,0	1,1	30	8,7	13,0	<b>SoftBox</b>		
<b>Chic Lounge</b>			<b>Normo</b>			10, S2		
A10	2,2	4,0	500			1C		
A20	2,1	3,3				11		
PV3	1,2	1,6	<b>Nu</b>			20		
CU	0,4	0,3	20			2B		
<b>Cushion</b>						2R, 2L		
CU30	0,4	-	<b>October</b>			21		
CU40	0,5	-	10			3B		
<b>Com</b>			10			3R, 3L		
22	0,5	0,3	20			31		
32	1,0	0,7	11			1CW*		
42	1,1	1,1	21			11W*		
22CV	0,5	0,3	31			2BW*		
42CV	0,7	0,8	12			2RW*, 2LW*		
			22			21W*		
			32			3BW*		
						3RW*, 3LW*		
						31W *		

\*refers only to screens

## Consumption of fabric and leather

	A	B		A	B
<b>Sorriso</b>			<b>Wall In</b>		
10	2,1	2,6	10, 11, 12, 13, B	1,5	2,0
<b>Trillo<sup>Pro</sup></b>			20, 21	1,8	2,7
20	0,6	-	22, 23	1,8	2,7
21	1,2	-	30, 31, 32	2,3	3,2
<b>Vancouver Lite</b>			C1, B1	1,6	1,4
1 H/V	2,6	4,1	C2, B2, P1	1,6	1,7
2 H/V	3,6	5,9	P3, P4	1,2	1,7
2,5 H/V	4,0	6,7	W	1,7	-
3 H/V	5,1	8,4	<b>Zoo</b>		
1 HW/VW	1,9	3,2	502	0,7	-
2 HW/VW	2,6	4,8	500	1,1	-
2,5 HV/VW	2,9	5,5			
3 HV/VW	3,5	6,5			
W1	6,7	-			
W2	6,7	-			
W2,5	8,9	-			
W3	8,9	-			
SW	5,5	-			
<b>Vancouver Oto</b>					
R1, R1B	1,2	1,6			
R2, R2B	1,0	1,1			
S1, S1B	1,8	2,6			
S2, S2B	1,1	1,3			

# Quilting

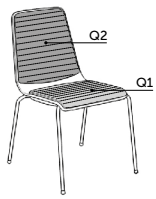

Bit / Com

Q1 - quilting on the seat pad  
Q2 - quilting on the backrest pad

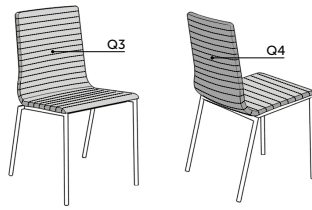

Acos<sup>Pro</sup> / Com

Q3 - quilting on the whole front part  
Q4 - quilting on the whole rear part



Nu / Sorriso

Q5 - quilting on the seat cushion

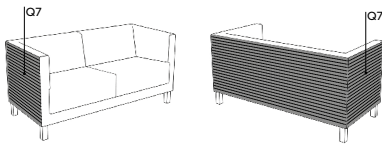

MyTurn Sofa / Vancouver Lite

Q7 - quilting on the outer part of the sides and the back

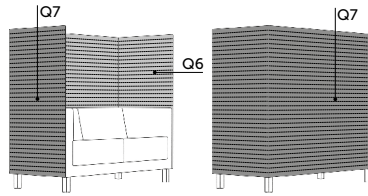

Vancouver Lite

Q6 - quilting on the inner part of the wall  
Q7 - quilting on the outer part of the wall

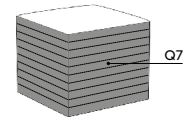

Vancouver Oto

Q7 - quilting on all of the sides

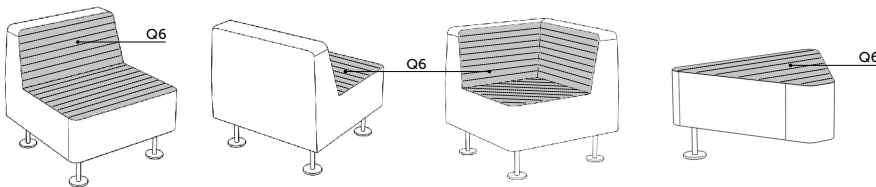

Wall In

Q6 - quilting on the seat and backrest

## Notes

---

---

---

---

---

---

---

---

---

---

---

---

---

---

---

---

---

---

---

---

---

---

---

---

---

---

---

---

---

---

# Measuring methodology

Swivel armchairs and chairs are measured with a mechanism adjusted in such a way that the seat is as much as it is possible positioned levelly, while the backrest vertically. Swivel armchairs and chairs are measured on their castors, whereas visitor and reception chairs on hard glides. The measurements are approximate and can differ depending on the product configuration.

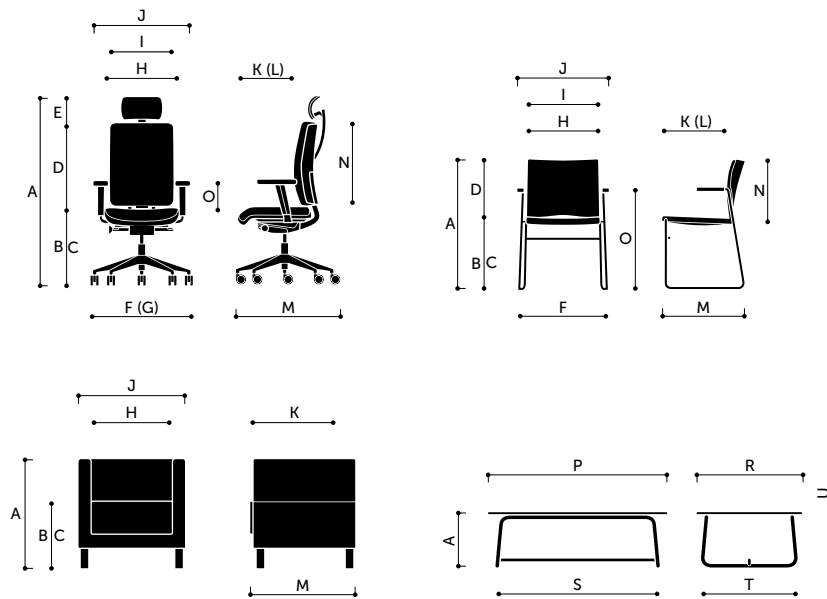

## A - Total height

For products fitted with a gas lift - it is measured with gas lift's minimum and maximum extension. For products fitted with an additional backrest and headrest height adjustment - it is measured in both minimum and maximum positions of the backrest, headrest and gas lift.

## B - Seat height

Measured at the highest point of the seat. For products fitted with a gas lift - it is measured with absorber's minimum and maximum extension.

## C - Seat height with the burden

Seat measured according to EN standards (with seat burden). For products fitted with a gas lift - it is measured with gas lift's minimum and maximum extension.

## D - Backrest height

Measured from the seat to the backrest upper edge. For products with adjustable backrest height - it is measured in the minimum and maximum position.

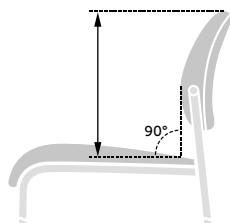

## E - Headrest height

Measured from the backrest upper edge to the headrest upper edge. The headrest adjusted in maximum vertical position in relation to the upper and lower edge of the headrest. Measured in the headrest's minimum and maximum position.

## F - Base, frame width

Measured at the uttermost points of the base according to the following figures.

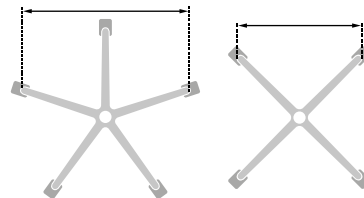

## G - Base diameter

Measured according to the figure underneath.

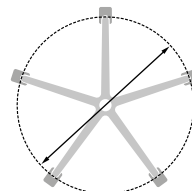

## H - Seat width

Measured at the uttermost points of the seat.

## I - Backrest width

Measured at the uttermost points of the backrest.

## J - Total width

Measured at the uttermost points. For products fitted with adjustable armrests - it is measured with the armrests slid apart to maximum. For products fitted with armrests with adjustable pads - it is measured with the pads slid apart to maximum.

# Measuring methodology

## K - Seat depth

Measuring the distance between the uttermost point on the seat and the point it touches the backrest (the contact point is determined with a level positioned vertically to the backrest by projecting the S point from the backrest onto the seat) (1). For some shell chairs, where there is no distinct border-line between the seat and the backrest, the depth is measured on the bend halfway between the seat and the backrest (2). For products with additional adjustable seat depth - it is measured with minimum and maximum slide.

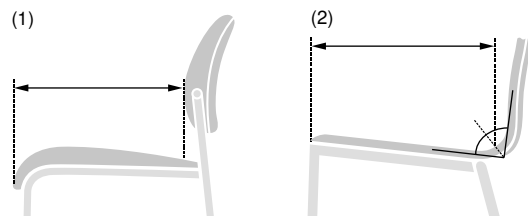

## L - Seat (element) length

Measured at the uttermost points of the seat.

## M - Total depth

Measured at the uttermost points. Swivel armchairs and chairs are measured according to the drawing underneath. For products with adjustable seat depth - it is measured with minimum and maximum slide.

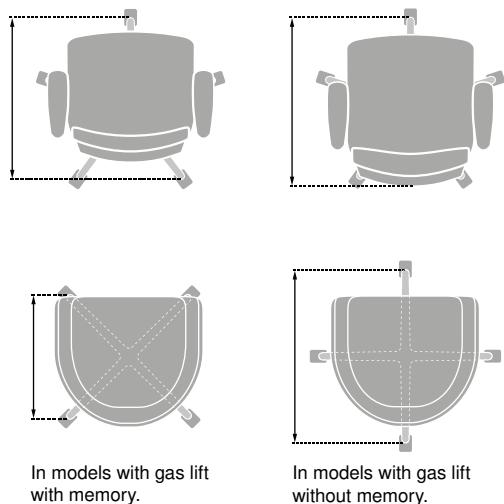

## N - Backrest (element) length

Measured at the uttermost points of the backrest.

## O - Armrest height

For swivel armchairs and chairs – it is measured from the seat surface to the armrest upper edge. For armrests with adjustable height – it is measured in the minimum and maximum position. For visitor chairs – it is measured from the floor to the armrest upper edge.

## P - Table top length

Measured at the uttermost points of the table top.

## R - Table top width

Measured at the uttermost points of the table top.

## S - Table frame length

Measured at the uttermost points of the table frame.

## T - Table frame width

Measured at the uttermost points of the table frame.

## U - Table top thickness

Table top (element) thickness is measured.

# Terms of guarantee

applies to products manufactured after January 15th, 2019

1. Profim (the Guarantor) guarantees the efficient operation of its products.
2. Claims must be submitted at the purchase location, on a claims form (which can be downloaded from [www.profim.eu](http://www.profim.eu)), together with a purchase document (invoice or guarantee) and the guarantee certificate, if the certificate in question was issued to the Purchaser.
3. Claimed products will be accepted only if cleaned, packaged, and secured against damage in shipping.
4. The claimed product should be delivered, along with the documents listed in point 2, to the purchase location. If the claim is rejected, the product is sent back to the purchase location at the cost of the Purchaser.
5. The Guarantor shall determine whether the claim is justified within 14 days from the claimed products' delivery to manufacturer (together with claim application). A claims department employee will contact the Purchaser by phone or e-mail in order to determine the date and manner of product repair/replacement. Any doubts related to the claims procedure may be clarified at the phone number + 48 63 289 88 40 from Monday to Friday, 9-15, or at the e-mail address [export@profim.pl](mailto:export@profim.pl). Submitting a claim does not entitle the Purchaser to withhold payment for the product.
6. In order to enable the manufacturer to identify the product, the claim notice should include information from the product's LABEL, i.e. the date of manufacture, order number, product number, and configuration. Any tampering with the LABEL will cause the guarantee to become null and void.
7. Guarantee period.  
Refers to the products listed in the current price list and on the website [www.profim.eu](http://www.profim.eu).

Guarantee period	Offer	Operating mode
<b>5 years</b> not longer however than 7 years from production date	Standard Classic - selected products	5 days a week, 8 hours per day (single shift work)
<b>3 years</b> not longer however than 4 years from production date	Classic	5 days a week, 8 hours per day (single shift work)

8. If the product is used for more than 8 hours per day, the guarantee period is reduced to three years.
9. Chair parts (e.g. castors, mechanisms, plastic parts) sold to the Purchaser are covered by a 2 years warranty.
10. If the product is replaced with another product free of defects or repaired by having one of its parts replaced, the course of the guarantee for such product or element is restarted. The guarantee period is extended by the period in which the Purchaser could not make use of the product.
11. If a defect cannot be removed or the removal involves excessive costs, the Guarantor may replace the product with another product free of defects. Any replaced defective products or parts thereof become the property of the Guarantor.
12. In case where an identical product is not available, the Guarantor may replace it with another product free of defects and with identical/similar parameters.

13. Claims concerning mechanical damage (scratches, dents, abrasions, upholstery soiling, missing parts etc.) will be accepted only if submitted within 7 days from the date of handing the product over to the Purchaser. By the above deadline, the Purchaser should unpack the product and remove the wrapping and protective elements in order to rule out mechanical damage. If reservations are made upon delivery with respect to the delivered product, a damage protocol must be drawn up in the presence of the courier or carrier and sent to the Guarantor together with the claims notice.
14. The refusal to hand the product (or any part thereof) over for repair in factory conditions, or preventing repair at the site of the Purchaser, causes the Guarantor to be released from its guarantee obligations and any guarantee claims to be waived.
15. The date of product repair at the site of the Purchaser is scheduled by the Guarantor.
16. Customized products i.e. chairs covered with fabric provided by the Purchaser and manufactured using technology that is not standard for a given product (such as using another base, armrests, covered by a fabric that is not part of standard offer etc.) are covered by one year guarantee.
17. The guarantee covers solely products located on the territory of the Republic of Poland or the country of the Distributor.
18. The Guarantor reserves the right to make innovations in the products that do not alter their durability and usability.
19. Repairs conducted by unauthorized persons or using unauthorized parts will cause the guarantee to become null and void.
20. The Purchaser's rights hereunder do not include the right to pursue lost profits and be indemnified for any potential damage caused by product failure.
21. The Guarantor's liability covers solely defects inherent in the product sold.
22. If the product is damaged after the expiry of the guarantee, the Guarantor may send, if possible, the Purchaser the required element or cure the defect using its factory service. In both cases the Purchaser will be charged accordingly.

# Terms of guarantee

applies to products manufactured after January 15th, 2019

## THE GUARANTEE DOES NOT COVER:

- a) defects caused by assembling the product in a manner not compliant with the manual and using it in a manner not compliant with its purpose,
- b) damage caused during transport and transloading (does not apply to transport provided by the Guarantor),
- c) failure to observe the recommendations contained in the user's manual, damage to castors, glides or floor caused by the inappropriate choice of available options (e.g. using hard castors on hard surfaces); the proper choice of options does not rule out damages that may be caused by using the chairs on carpets, panels, parquet floors etc. of inappropriate quality or on soiled surfaces (e.g. by sand),
- d) damage resulting from extreme climate conditions or environmental factors (e.g. acids, humidity etc.),
- e) damage caused by departing from standard specifications at the customer's request,
- f) operational wear and tear of wheels or upholstery materials,
- g) wear and tear of felt glides, which can be replaced under warranty, only in case the felt come away,
- h) differences in the fabrics shade, if the products come from different manufacturing series of the fabric manufacturer, and differences in individual products purchased by the Purchaser successively are claimed,
- i) discoloration of upholstery caused by some of the clothing colourants and additional colourants (such as those used in denim) which may transfer onto lighter upholstery (the effect can be intensified due to humidity and temperature and is irreversible),
- j) soiling and permanent discolouring of upholstery caused by external factors,
- k) leather upholstery products, where the natural features of the material, such as smell, difference in the structure, texture and shade differences, scars and insects pricks are claimed; during use (e.g. on the seat) the leather takes on shine and becomes looser; the Guarantor does not accept claims motivated by the above features,
- l) foam deformations,
- m) differences in the hardness of polyurethane cold-moulded foam resulting from parameter variations, which according to the DIN 53576/ISO 2439 norm are acceptable if within the range of +/- 10%,
- n) damaging the surface of wooden elements as a result of contact with the edges of desks or other office furniture; mechanical damage of wooden surfaces is not considered to be a product defect,
- o) wooden components used in products, if the slight differences occurring in individual elements are claimed; the character of the raw material makes it impossible to precisely determine the final aesthetic effects, defined by the wood colour, shade, and figure,
- p) differences in geometry of plywood shells, which, because of their natural properties, may differ in tolerance of +/- 1.5 degrees,
- r) small variations in HPL colours, in accordance with PN-EN 438 norm.
- s) differences in colour, gloss, tone or pattern in ceramic table tops. It is natural material and above features are characteristic of this type of surface.

## GENERAL REMARKS CONCERNING PRODUCT USE:

23. The products should be protected against the direct influence of sunrays.
24. Leather products should not be placed next to a heater or another heat source. Please observe a minimum distance of 30 cm from the heat source.
25. Leather should be maintained using special care products that create a protective layer resistant to water and oil substances.
26. Products should be protected against becoming wet.
27. The upholstery fabric should be protected against soiling by grease, sweat, lubricants etc. In case of soiling, apply appropriate cleaning agents.
28. Avoid exposing upholstery to extensive, focused tension (for example standing on a chair) that can result in splitting or a rip of stitching as well as mechanical damage to upholstery.
29. Upholstered furniture is supposed to be used to sit evenly on the seat surface to avoid natural tendency of fabrics and leather to creasing and wrinkling due to ongoing pressure, temperature and the moist of the body (wrinkling and creasing is not a product fault but a natural effect; the bigger the upholstered surface the higher tendency for this effect to occur).
30. Products should be dusted at least once a week.
31. Hard castors are used with soft carpeting and carpets.
32. Soft castors are used with hard floors (e.g. PVC, parquet floors, floor panels).
33. Remarks concerning the use of products containing plywood elements:
  - temperature range from +15°C to +30°C,
  - humidity range from 40% to 65%.
34. Ceramic tops meet the frost resistance requirements per EN 10545-12.
35. Table Chic RH and RR with metal and ceramic table top (apply only when frame/column is made of EPO1, EPO2, EPO3, with hard or teflon glides) can be for outdoor use according to EN 12944-2 cat. C3.
36. Plastic elements of the products like bases, armrests cover (especially light grey colours) require regular cleaning adequate to density of usage.



# Fabrics and finishings

# Profim Standard fabrics

## EVO - PRICE GROUP 0

Evo is a uni-coloured polyester crepe fabric. The irregular weave structure add shine and good stretch.

**Composition:** 100% polyester

**Weight:** 320 g/m<sup>2</sup>

**Abrasion resistance:** 180 000 Martindale (EN ISO 12947-2)

**Flammability:** BS EN 1021: 1-2 (Cigarette & match)

**Light fastness:** 4-5 (EN ISO 105-B02)

**Rubbing fastness:** 4-5 (Wet/Dry) (EN ISO 105-X12)

**Pilling resistance:** 5 (EN ISO 12945-2)

**Environmental facts:** EU Ecolabel, Oeko-Tex® Standard 100, ISO 14001 certified company

**Design:** Miranda Design Team

**Produced in:** Poland

**Cleaning & disinfection:** Dry cleaning with tetrachloroethylene and water solution of carbonate fluoride

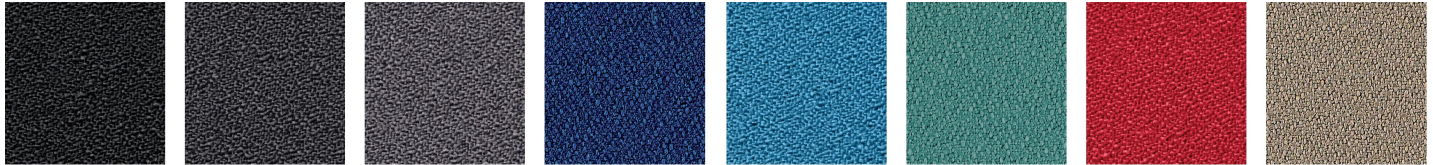

EVO011

EVO001

EVO014

EVO010

EVO025

EVO024

EVO005

EVO002

## CURA (GABRIEL) - PRICE GROUP 1

Cura is a two-coloured fabric made from 98% post-consumer recycled polyester. It has a matt, slightly irregular and natural-looking texture where the dark, underlying grey fibers create a discreet yet vibrant melange effect. High durability and stretchability and its soft, voluminous touch make Cura suitable for both office and lounge furniture.

&nbsp;

**Composition:** 100% post-consumer recycled polyester

**Weight:** 420 g/m<sup>2</sup>

**Abrasion resistance:** 100 000 Martindale (EN ISO 12947-2)

**Flammability:** BS EN 1021: 1-2, BS 5852 0&1, CA TB 117-2013, ASTM E 84 Class I

**Light fastness:** 5-8 (EN ISO 105 - B02)

**Rubbing fastness:** 4-5/4-5 (Wet/Dry) (EN ISO 105X12)

**Pilling:** 4-5 (EN ISO 12945-2)

**Environmental facts:** EU Ecolabel, Oeko-Tex® Standard 100, Contains no Flame Retardant chemicals, ISO 14001 certified company

**Design:** Cenk Kivrikoglu

**Produced in:** Lithuania

**Cleaning:** Wash or dry cleaning, Can be disinfected with ethanol and is bleach-cleanable (For further info follow Gabriel´s cleaning guidelines - [www.gabriel.dk](http://www.gabriel.dk))

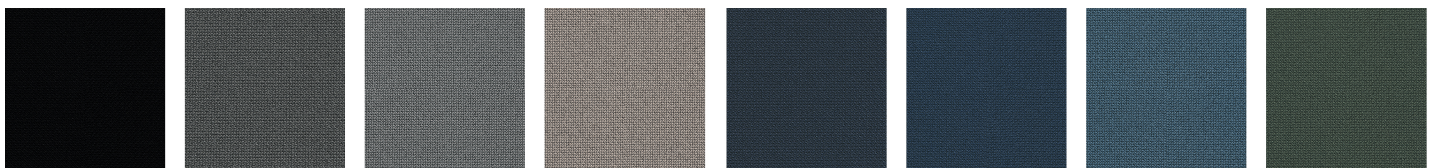

CU60999

CU60109

CU60110

CU61168

CU66165

CU66170

CU66167

CU68182

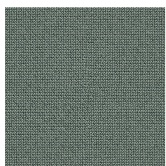

CU68186

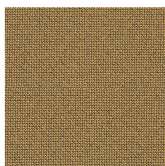

CU62083

## TONAL (GABRIEL) - PRICE GROUP 1

Tonal is a post-consumer recycled polyester fabric in a two-coloured melange. It has a discreet textured look with a fusion of light and dark tones adding depth to the colours.

**Composition:** 99% post-consumer recycled polyester, 1% polyester

**Weight:** 315 g/lm

**Abrasion resistance:** 100 000 Martindale (EN ISO 12947-2)

**Flammability:** BS EN 1021: 1-2, BS 476 Part 7 class 1, CA TB 117-2013, ASTM E 84 Class I

**Light fastness:** 6-8 (EN ISO 105 - B02)

**Rubbing fastness:** 4-5/4-5 (Wet/Dry) (EN ISO 105X12)

**Pilling:** 4-5 (EN ISO 12945-2)

**Environmental facts:** EU Ecolabel, Oeko-Tex® Standard 100, Contains no Flame Retardant chemicals, ISO 14001 certified company

**Design:** Cenk Kivrikoglu

**Produced in:** Lithuania

**Cleaning:** Wash or dry cleaning. Can be disinfected with ethanol and is bleach-cleanable (For further info follow Gabriel's cleaning guidelines - [www.gabriel.dk](http://www.gabriel.dk))

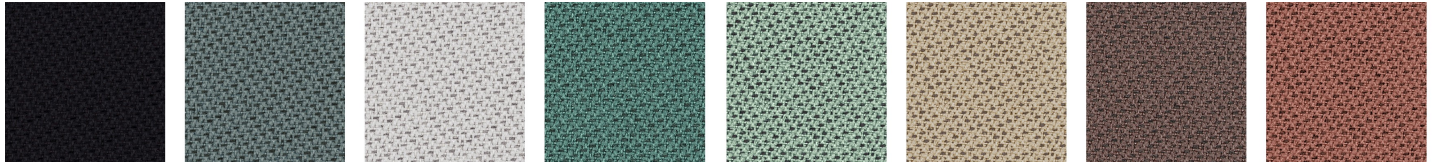

TL60999

TL60124

TL60122

TL67090

TL67089

TL61180

TL64211

TL64210

## XTREME (CAMIRA) - PRICE GROUP 1

Xtreme is a crepe fabric made from 100% post-consumer recycled polyester that features exceptional Euro flammability performance. Extra stretch and structure gives an irregular, shiny finish.

**Composition:** 100% post-consumer recycled polyester

**Weight:** 310 g/m2

**Abrasion resistance:** >100 000 Martindale (EN ISO 12947-2)

**Flammability:** BS EN 1021: 1-2 (Cigarette & match), BS 7176 Low & Medium Hazard, BS 5852 Section 4 Crib 5, DIN 4102 B1, UNI 9175 Class 1 IM, NF D 60-013

**Light fastness:** 6 (EN ISO 105 - B02: 2013)

**Rubbing fastness:** 4/4 (Wet/Dry) (EN ISO 105X12)

**Pilling:** 5 (EN ISO 12945-2)

**Environmental facts:** EU Ecolabel, Oeko-Tex® Standard 100, Indoor Advantage™ "Gold", non metallic dyestuffs, ISO 14001 certified company.

**Design:** Camira Design Studio

**Produced in:** United Kingdom

**Cleaning & disinfection:** Washable to 60 °C and bleach cleanable (For further info follow Camira's cleaning guidelines - [www.camirafabrics.com](http://www.camirafabrics.com))

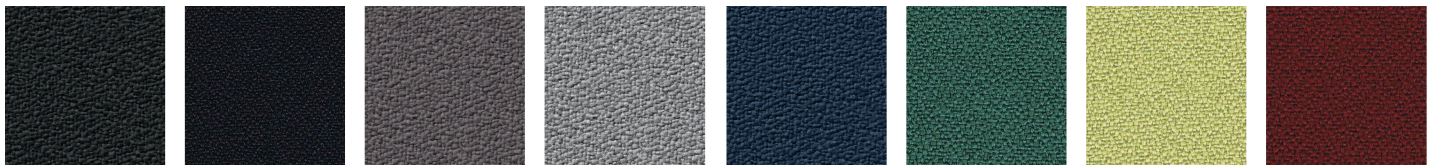

EXR009

EXR145

EXR081

EXR094

EXR026

EXR047

EXR096

EXR136

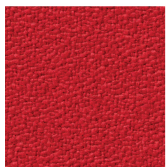

EXR079



## SELECT (GABRIEL) - PRICE GROUP 2

Select is a classic woolen fabric with a tightly woven relief structure, combining excellent softness, stretch and durability. Its rich texture with the interplay of light and shadow add depth in all the colours in the palette.

**Composition:** 85% New Zealand wool, 15% polyamide

**Abrasion resistance:** 200 000 Martindale (EN ISO 12947-2)

**Flammability:** BS EN 1021: 1-2, BS 5852 0&1, BS5852 Crib 5, CA TB 117-2013, IMO MSC 307(88) Annex 1 part 8/MED registration IMO

**Light fastness:** 5-8 (EN ISO 105 - B02)

**Rubbing fastness:** 4-5/4-5 (Wet/Dry) (EN ISO 105X12)

**Pilling:** 4 (EN ISO 12945-2)

**Environmental facts:** EU Ecolabel, Oeko-Tex® Standard 100, 100% free of heavy metals, ISO 14001 certified company

**Design:** Cenk Kivrikoglu

**Produced in:** Lithuania

**Cleaning:** Professional dry cleaning (For further info follow Gabriel's cleaning guidelines - [www.gabriel.dk](http://www.gabriel.dk))

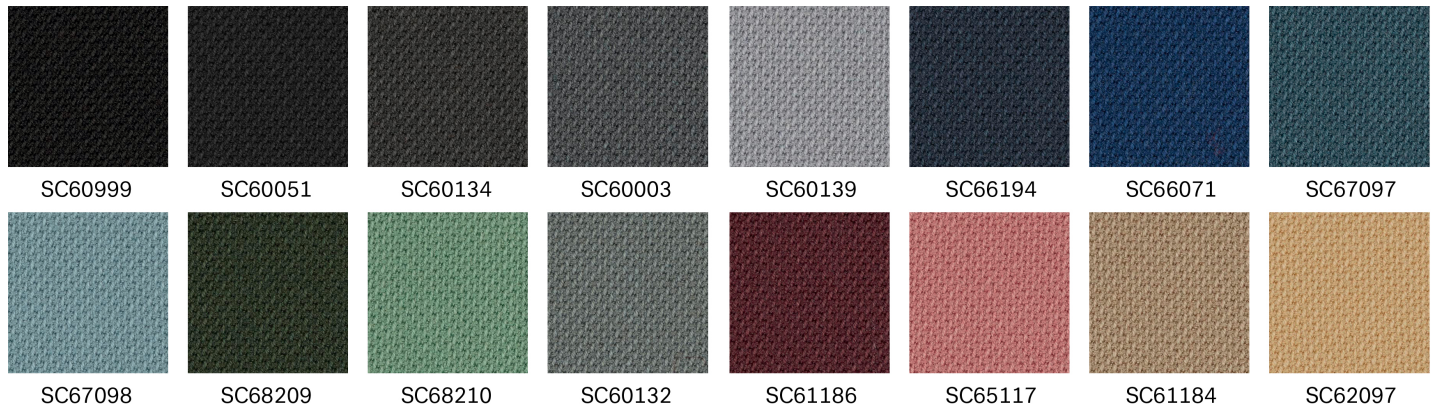

## CAPTURE (GABRIEL) - PRICE GROUP 3

Capture is a lightly felted and multi-coloured wool fabric combining softness, stretch and strenght. It fuses light and dark colours to a refined melange pattern in subtle nuances, which add richness and depth to the design.

**Composition:** 85% New Zealand wool, 15% polyamide

**Abrasion resistance:** 200.000 Martindale (EN ISO 12947-2)

**Flammability:** BS EN 1021: 1-2 (Cigarette & match), BS 5852 Part 1 0,1 (Cigarette & match), CA TB 117-2013, Class Uno UNI 9175 Class 1 IM

**Light fastness:** 5-7 (EN ISO 105-B02)

**Rubbing fastness:** 4-5/4-5 (Wet/Dry) (EN ISO 105X12)

**Pilling:** 4-5 (EN-ISO 12945-2)

**Environmental facts:** EU Ecolabel, Oeko-Tex® Standard 100, 100% free of heavy metals, ISO 14001 certified company

**Design:** Cenk Kivrikoglu

**Produced in:** Lithuania

**Cleaning:** Professional dry cleaning (For further info follow Gabriel's cleaning guidelines - [www.gabriel.dk](http://www.gabriel.dk))

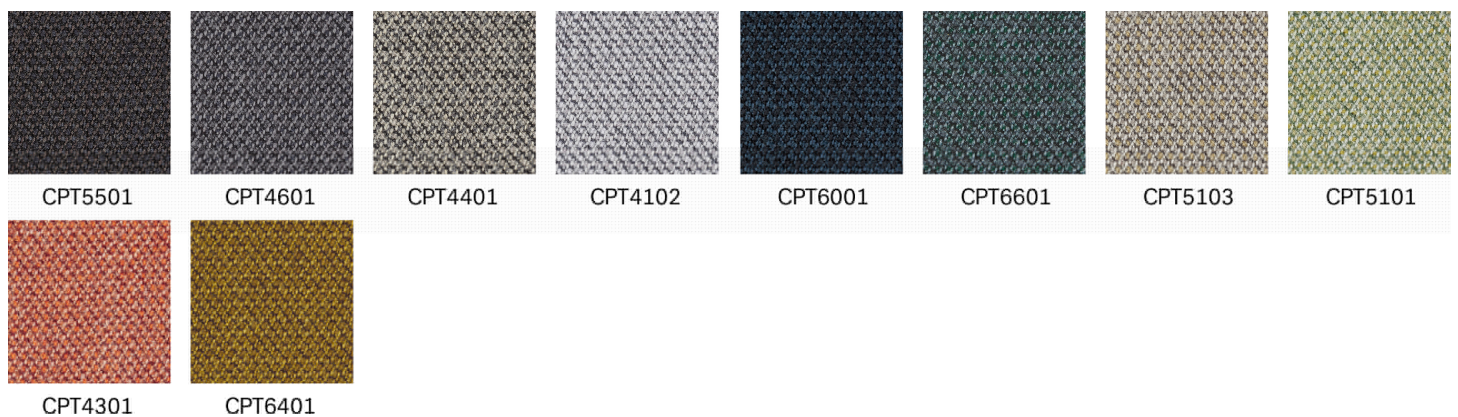

## OCEANIC (CAMIRA) - PRICE GROUP 3

Oceanic is made from 100 % post-consumer recycled polyester yarn where 90% are created from post-consumer plastic bottles diverted from landfill and 10% is upcycled marine plastic(from marine litter). It is a fabric born out of the SEAQUAL Initiative designed to combat marine plastic pollution and achieve a waste free environment. Oceanic has a two coloured diagonal structure with a matte surface and soft touch.

**Composition:** 100 % post-consumer recycled polyester, including 50% SEAQUAL yarn

**Weight:** 497 g/m2 ±5%

**Abrasion resistance:** >100 000 Martindale (EN ISO 12947-2)

**Flammability:** BS EN 1021: 1-2 (Cigarette & match), BS 7176 Low, BS 7176 Medium Hazard with EnviroFlam5, CA TB 117-2013

**Light fastness:** 5 (EN ISO 105 - B02: 2013)

**Rubbing fastness:** 4/4 (Wet/Dry) (EN ISO 105X12)

**Pilling:** 4 (EN ISO 12945-2)

**Environmental facts:** EU Ecolabel, Oeko-Tex® Standard 100, Indoor Advantage™ "Gold", non metallic dyestuffs, ISO 14001 certified company.

**Design:** Camira Design Studio

**Produced in:** United Kingdom

**Cleaning & disinfection:** Washable at 60 °C and bleach cleanable (For further info follow Camira´s cleaning guidelines – [www.camirafabrics.com](http://www.camirafabrics.com))

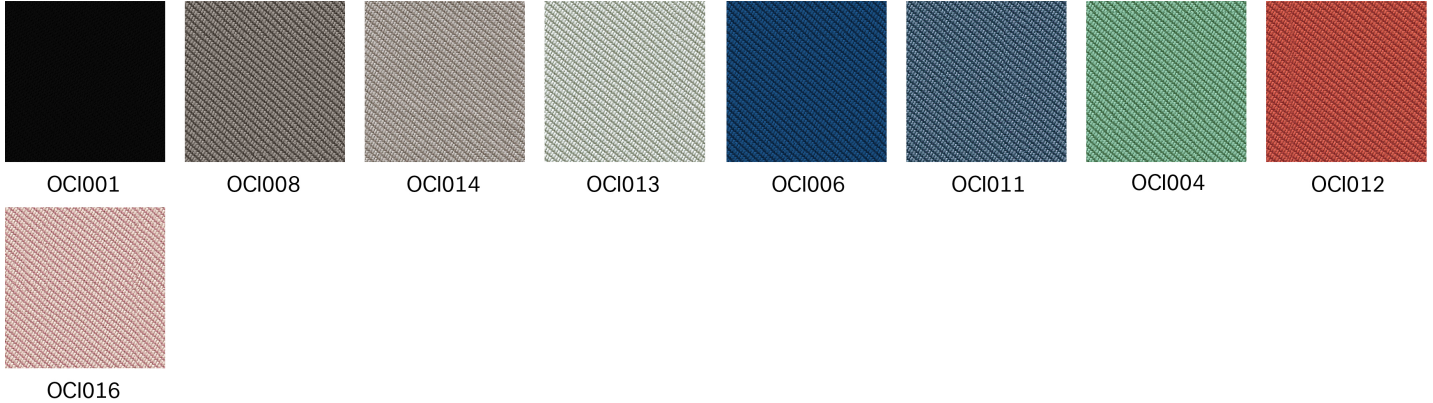

## STEP (GABRIEL) - PRICE GROUP 3

Step is unique in both texture and performance. With its delicate surface, Step is perceived as vivid and interesting. The texture with the fire-resistant Trevira CS yarn ensures that the fabric is suited for use in environments with high fire safety and durability requirements.

**Composition:** 100% Trevira CS

**Weight:** 336 g/m2

**Composition:** 100% Trevira cs

**Abrasion resistance:** 100 000 Martindale (EN ISO 12947-2)

**Flammability:** BS EN 1021: 1&2 (Cigarette & match), BS 5852 0&1 (Cigarette & match), BS 5852 Crib 5, CA TB 117-2013, MED Certificate IMO, Class Uno UNI 9175 Class 1 EMME, ÖNORM

**Light fastness:** 5-7 (EN ISO 105 - B02)

**Rubbing fastness:** 4-5/4-5 (Wet/Dry) (EN ISO 105X12)

**Pilling:** 4-5 (EN ISO 12945-2)

**Environmental facts:** EU Ecolabel, Oeko-Tex® Standard 100, 100% free of heavy metals, ISO 14001 certified company

**Design:** Inger Mosholt Nielsen

**Produced in:** Lithuania

**Cleaning:** Professional dry cleaning (For further info follow Gabriel's cleaning guidelines [www.gabriel.dk](http://www.gabriel.dk))

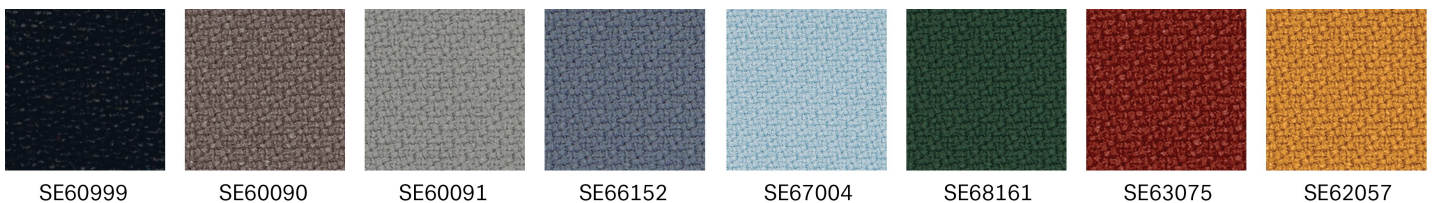



## SYNERGY (CAMIRA) - PRICE GROUP 3

Epitomising natural simplicity, Synergy is a wool rich fabric which is at once both irresistibly soft and ultra-high performing. Delicately felted, with a beautifully relaxed drape, the understated aesthetics showcase the intriguing coloration of this considered textile.

---

**Composition:**

- 95% wool
- 5% polyamide
- **Weight:** 400 g/m<sup>2</sup>

---

**Certificates:**

- **Abrasion resistance:** 100000 Martindale cycles (BS-EN ISO 12947-2)
- **Pilling resistance:** 4 (BS-EN ISO 12945-2)
- **Flammability:** cigarette (BS-EN 1021-1)
- **Flammability:** match (BS-EN 1021-2)
- **Flammability:** (UNI 9175 Class 1IM)
- **Light fastness:** 5 (ISO 105-B02)
- **Maintenance:**
  - -vacuum regularly
  - -use dry-clean preparations
  - -do not bleach

---

Because of the fact that the fabric Synergy is composed of 95% natural fiber, each of the batches shows variations in shade, which may be visible in products of follow-up orders. Additionally, an inherent feature of all natural fibers is the tendency to delicate fabric pilling.

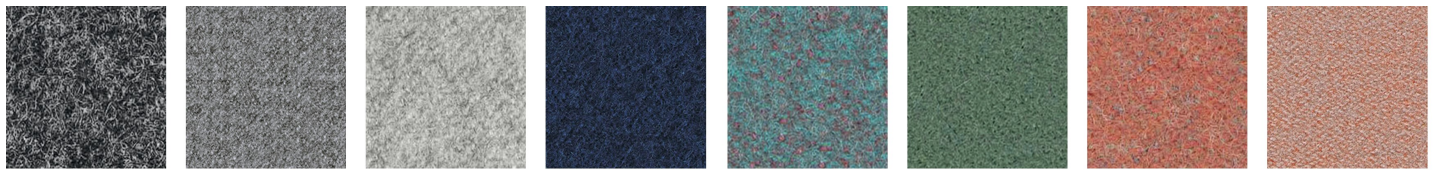

SGY017

SGY016

SGY008

SGY062

SGY056

SGY049

SGY073

SGY074

## STEELCUT 3 (KVADRAT) - PRICE GROUP 4

Steelcut 3 is a unicoloured strong worsted wool and polyamide woven fabric, combining durability, soft touch and colour depth. The construction create a three-dimensional surface resembling small pyramids or steel points. Despite its complex weaving technique, it has a simple and precise expression.

**Composition:** 90% worsted new wool, 10% polyamide

**Weight:** 825 g/lm

**Abrasion resistance:** 100 000 Martindale (EN ISO 12947-2)

**Flammability:** BS EN 1021: 1-2 (Cigarette & match, CA TB 117-2013, BS 5852 Crib 5 (with treatment), BS 5852 part 1, IMO FTP Code 2010 Part 8, NF D 60 013, NFPA 260, UNI 9175 1IM, ÖNORM B1/Q1, AS/NZS 3837 Class 2, ASTM E84 Class A Unadhered, ASTM 84 Class B Adhered

**Light fastness:** 5 6 (EN ISO 105-B02)

**Rubbing fastness:** 3-5/4-5 (Wet/Dry) (EN ISO 105X12)

**Pilling:** 3-4 (EN ISO 12945-2)

**Environmental facts:** EU Ecolabel, 100% free of heavy metals, ISO 14001 certified company, GREENGUARD Gold

**Design:** Frans Dijkmeijer, Giulio Ridolfo (updated colourways)

**Produced in:** United Kingdom

**Cleaning:** Professional dry cleaning with tetrachloroethylene, normal process (For further info follow Kvadrat's cleaning guidelines – [www.kvadrat.dk](http://www.kvadrat.dk))



STT190

STT655

## STEELCUT TRIO 3 (KVADRAT) - PRICE GROUP 4

Steelcut Trio 3 is a strong worsted wool and polyamide woven fabric, made with three different coloured yarns. The colours and the special weave create a three-dimensional surface where the colours seem to change depending on the angle of perspective. Like Steelcut 3, despite the complexity of the textile's innovative weave, it has a simple, precise expression.

**Composition:** 90% worsted new wool, 10% polyamide

**Weight:** 770 g/lm

**Abrasion resistance:** 100 000 Martindale (EN ISO 12947-2)

**Flammability:** BS EN 1021: 1-2 (Cigarette & match, CA TB 117-2013, . BS 5852 Crib 5 (with treatment), BS 5852 part 1, BS 5852 ignition source 3, IMO FTP Code 2010 Part 8, NF D 60 013, NFPA 260, UNI 9175 1IM, ÖNORM B1/Q1, AS/NZS 3837 Class 2, GB 50222 B1 with treatment (Chinese)

**Light fastness:** 6-7 (EN ISO 105-B02)

**Rubbing fastness:** 3-5/4-5 (Wet/Dry) (EN ISO 105X12)

**Pilling:** 4 (EN ISO 12945-2)

**Environmental facts:** EU Ecolabel, 100% free of heavy metals, ISO 14001 certified company, GREENGUARD Gold

**Design:** Frans Dijkmeijer, Giulio Ridolfo (updated colourways)

**Produced in:** United Kingdom

**Cleaning:** Professional dry cleaning with tetrachloroethylene, normal process (For further info follow Kvadrat's cleaning guidelines – [www.kvadrat.dk](http://www.kvadrat.dk))

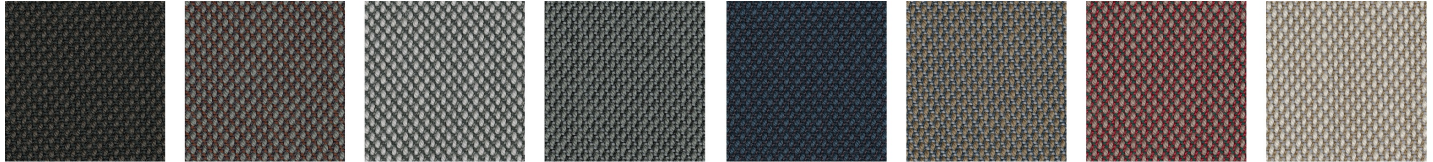

STT383

STT276

STT133

STT153

STT796

STT253

STT645

STT213

## PALOMA SOFT (WOLLSDORF) - PRICE GROUP 6

High quality semi-aniline leather. All our standard colours from Paloma have a special finish adding a particular softness to the leather. Excellent friction and breathing properties. The surface may feature small scars and marks resulting from insect bites etc. These are proof of the natural origin of the product and are part of its character.

**Flammability:** BS EN 1021: 1-2 (Cigarette & match), BS 5852 Crib 5, IMO A.652 (16)

**Light fastness:** 6 (EN ISO 105-B02)

**Rubbing:** Wet 80/4 -Dry 2000/4 - Sweat 50/4 - ISO 11640

**Finish-adhesion:** 2.0 N/cm ISO 11644

**Tear-strength:** 20 N/mm DIN 53329- A

**Environmental facts:** Tanned without using chromium salts, BlueAngel, ECO2L-certificate, ISO 14001 certified company

**Produced in:** Austria

**Animal Welfare:** All hides are by-products from the meat and dairy industries, only use hides from healthy and uninjured animal. Following European standards as a minimum and the "Five Freedoms" of livestock as defined by FAWC (Farm Animal Welfare Council)

**Cleaning:** Follow the leather care guide from our supplier – [www.wollsdorf.com](http://www.wollsdorf.com)



ATG56100

ATG55185

ATG55206

ATG55115

ATG55130

# Fabrics and finishings

## Mesh

Ariz

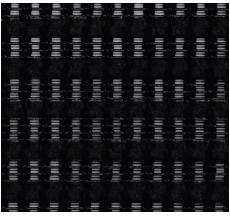

GZ-21

## Mesh

Bit

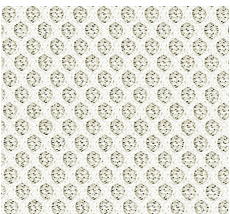

Runner 60061

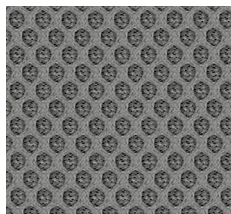

Runner 60011



Runner 60999

## Plastics

Ariz



CODE 20



CODE 517

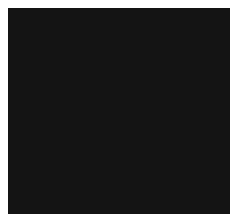

CODE 01



CODE 516



CODE 503



CODE 513



CODE 3020

Finishings colours in print may differ from real ones.



# Fabrics and finishings

## Plastics

Ellie<sup>Pro</sup>/ Trillo<sup>Pro</sup>

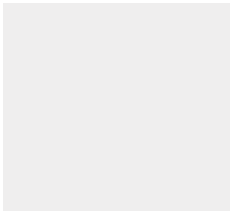

Light grey (RAL 7047)



Black

## Plastics

Mickey

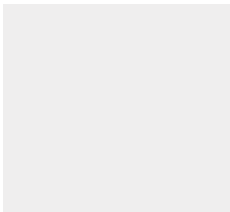

Light grey (RAL 7047)



Grey (RAL 7043)

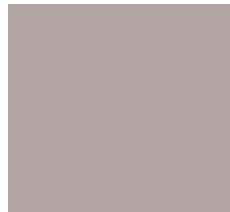

Beige (RAL 7036)

## Plastics / frames

Zoo

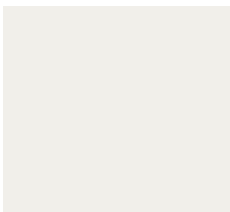

Light grey (NCS S 2500-N)



Grey (NCS S 6500-N)

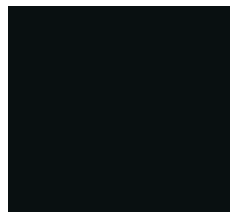

Black (RAL 9005)

# Fabrics and finishings

## Tempered glass

Chic Tables



G1 (Milky)



G2 (Black)



G3 (RAL 7044)



G4 (RAL 7042)

# Kolory stelaży / Frame colours / Gestellfarben

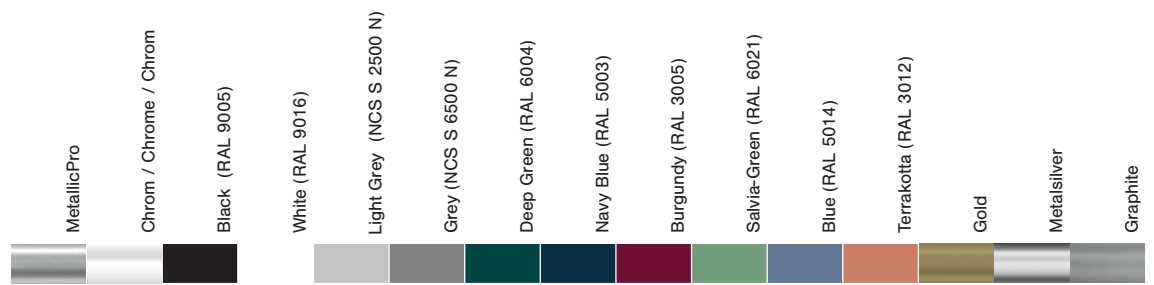

		MetallicPro	Chrom / Chrome / Chrom	Black (RAL 9005)	White (RAL 9016)	Light Grey (NCS S 2500 N)	Grey (NCS S 6500 N)	Deep Green (RAL 6004)	Navy Blue (RAL 5003)	Burgundy (RAL 3005)	Salvia-Green (RAL 6021)	Blue (RAL 5014)	Terrakotta (RAL 3012)	Gold	Metalsilver	Graphite
Acos <sup>Pro</sup>	V, H, HC	○	○	○	○	○	○	○	○	○	○	○	○			
Arca	V, V PP	○	○	○	○											
Ariz	V, V 2P, CV	○	○	○	○	○	○	○	○	○	○	○	○			
Bit	H, V	○	○	○	○											
Chic	H	○	○	○	○	○	○	○	○	○	○	○	○	○		
Chic	CH, CR	○	○	○	○	○	○	○	○	○	○	○	○			
Chic Air	H	○	○	○												
Chic Lounge	V3, PV3, F	○	○	○	○	○	○	○	○	○	○	○	○	○		
Chic Tables	RR	○	○	○	○	○	○	○	○	○	○	○	○			
Chic Tables	RH, CS, CR	○	○	○	○	○	○	○	○	○	○	○	○	○		
Com	HC, HF, HS	○	○	○	○	○	○	○	○	○	○	○	○	○		
Com	H, H 2P, V, CV, V1, V1 2P, V2	○	○	○	○	○	○	○	○	○	○	○	○			
Com	L3, L4	○		○												
Ellie <sup>Pro</sup> (polished alu)	HST	○	○	○	○											○
Ellie <sup>Pro</sup>	V3	○		○	○	○	○							○	○	
Fan	H, HC, HS, V	○	○	○	○	○	○	○	○	○	○	○	○	○		
Fan	R	○	○	○	○	○	○	○	○	○	○	○	○			
MyTurn Sofa	H, V	○	○	○												
MyTurn Sofa Tables	H, V	○	○	○												
MyTurn	VN		○													
Normo	H, V, HS, HC	○		○	○	○	○	○	○	○	○	○	○			
Nu	H, V3	○	○	○	○	○	○	○	○	○	○	○	○	○		
Nu (polished alu)	HC	○	○	○	○											○
Nu	R	○	○	○	○	○	○	○	○	○	○	○	○			
October	-	○	○	○												
October Tables	-	○	○	○												
Revo Tables	-	○		○	○	○	○	○	○	○	○	○	○			
Seven	-	○		○	○	○	○	○	○	○	○	○	○			
Snap	-	○		○	○	○	○	○	○	○	○	○	○	○		
SoftBox (polished alu)	-		○	○												
SoftBox Tables	-		○	○												
Sorriso	V	○	○	○												
Sun	H, V, H 2P, H 2PB	○	○	○												
Tables	SV, SH, SR	○	○	○	○	○	○	○	○	○	○	○	○			
Trillo <sup>Pro</sup> (polished alu)	HST	○	○	○	○											○
Vancouver Lite	H, V	○	○	○												
Wall In	-	○	○	○												
Xenon	H, V, H 2P, V 2P	○	○	○												
Xenon Net	H, V, H 2P, V 2P	○	○	○												
Zoo	H, V, H 2P, V 2P, HC, HC 2P	○	○	○	○	○	○									
Zoo	L3, L4	○		○												

# Kolory drewna i sklejkki / Wood colours / Holzfarben

	Sklejka bukowa / Stained beech / Holz (Schichtholz Buche)			Okleiny naturalne / Natural veneers / Beiztöne Holz				Okleiny naturalne barwione / Coloured natural veneers / Farben von Edel furnier				
	H6	H12	H5	Ash (NA)	Beech (NB)	Oak (NO)	Walnut (NW)	White Ash CNA01	Black Ash CNA02	Deep Green Ash CNA05 (RAL 6004)	Navy Blue Ash CNA06 (RAL 5003)	Burgundy Ash CNA07 (RAL 3005)
Chic	<input type="radio"/>	<input type="radio"/>	<input type="radio"/>									
Chic Tables				<input type="radio"/>	<input type="radio"/>	<input type="radio"/>	<input type="radio"/>	<input type="radio"/>	<input type="radio"/>	<input type="radio"/>	<input type="radio"/>	<input type="radio"/>
Com	<input type="radio"/>	<input type="radio"/>	<input type="radio"/>	<input type="radio"/>		<input type="radio"/>	<input type="radio"/>	<input type="radio"/>	<input type="radio"/>	<input type="radio"/>	<input type="radio"/>	<input type="radio"/>
Ellie <sup>Pro</sup>	<input type="radio"/>	<input type="radio"/>	<input type="radio"/>									
Fan	<input type="radio"/>	<input type="radio"/>	<input type="radio"/>									
MyTurn Sofa Tables												
Nu	<input type="radio"/>	<input type="radio"/>	<input type="radio"/>									
October	<input type="radio"/>	<input type="radio"/>	<input type="radio"/>									
October Tables	<input type="radio"/>	<input type="radio"/>	<input type="radio"/>									
Revo Tables				<input type="radio"/>	<input type="radio"/>	<input type="radio"/>	<input type="radio"/>	<input type="radio"/>	<input type="radio"/>	<input type="radio"/>	<input type="radio"/>	<input type="radio"/>
SoftBox	<input type="radio"/>	<input type="radio"/>	<input type="radio"/>									
SoftBox Tables												
Tables SH/SR												
Tables SW	<input type="radio"/>	<input type="radio"/>	<input type="radio"/>									
Wall In												

# Kolory drewna i sklejkki / Wood colours / Holzfarben

	Okleiny naturalne modyfikowane / Natural modified veneers / Beiztöne Holz								Drewno (dąb) / Wood (Oak) / Holz (Buche)					
	HM10	HM11	HM12	HM20	HPL	White LW01 (RAL 9016)	Light Grey LW03 (NCS S 2500-N)	Grey LW04 (RAL 7037)	Black LW02 (RAL 9011)	Navy Blue LW06 (RAL 5003)	Light Burgundy LW07 (RAL 3004)	HO6	HO12	HO11
Chic														
Chic Tables														
Com						o	o	o	o	o	o			
Ellie <sup>Pro</sup>														
Fan												o	o	o
MyTurn Sofa Tables	o	o	o	o		o		o	o					
Nu														
October														
October Tables														
Revo Tables						o	o	o	o	o	o			
SoftBox														
SoftBox Tables	o	o	o	o		o		o	o					
Tables SH/SR						o	o	o	o	o	o			
Tables SW												o	o	o
Wall In						o	o	o	o	o	o			

## Kolory kubeków / Shell colours / Schalenfarbe

Legenda / Legend / Legende:

- Standardowy czas realizacji / Standard delivery time / Standardlieferzeit
- Wydłużony czas realizacji / Extended delivery time / Verlängerte Lieferzeit

Model	Plastics														Veneer shell		
	Poppy	Vanilla	Straw	Rose	Coral	Sky	Sea Green	Teal Blue	Forest	Misty Grey	Clay	Graphite	Graphite – recycled PP	Charcoal	Oak	Dark stained Oak	
Ana	●	●					○	●		●		●	●				
Noor 6050/6055	○	●	○	○	○	○	●	●	○	●	●	●			●	○	
Noor 6060/6065	○	●	○	○	○	○	●	●	○	●	●	●			●	○	
Noor 6070/6075	○	●	○	○	○	○	●	●	○	●	●	●			●	○	
Noor 6080/6085	○	●	○	○	○	○	●	●	○	●	●	●			●	○	
Noor Up 6090/6095	○	●	○	○	○	○	●	●	○	●	●	●			●	○	

## Kolory stelaży / Frame colours / Gestellfarbe

Legenda / Legend / Legende:

- Standardowy czas realizacji / Standard delivery time / Standardlieferzeit
- Wydłużony czas realizacji / Extended delivery time / Verlängerte Lieferzeit

Model	Frames											Aluminium elements				Wood (Ash)			Aluminium elements for base 6080/6085	
	Lingon RAL 3000	Snow (White) RAL 9016	Canola	Rose	Aqua	Sea Green	Teal Blue	Forest	Misty Grey	Black RAL 9005	Metalsilver	Steelgrey	Polished Alu	White stained Ash	Stained Ash	Dark stained Ash	Black painted Aluminium frame	Polished Aluminium frame		
Ana	○	●				○	●		●	●	●						●			
Noor 6050/6055	○	○		○		●	●	○	○	●	●									
Noor 6060/6065	○	●	○	○	○	●	●	○	○	●	●									
Noor 6070/6075		○							●			○								
Noor 6080/6085														○	●	○	●	○		
Noor Up 6090/6095	○	●	○	○	○	●	●	○	○	●	●						●			

## Kolory blatów / Table tops colours / Plattefarbe

Legenda / Legend / Legende:

- Standardowy czas realizacji / Standard delivery time / Standardlieferzeit
- Wydłużony czas realizacji / Extended delivery time / Verlängerte Lieferzeit

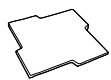

	<b>HPL</b>													<b>Linoleum</b>					<b>Melamine</b>	
	Polar White Mat Formica F2255	Folkstone Formica F7927	Sarum Grey Formica F2770	Diamond Black Formica F2253	Oak natural Formica F1079	Birch Formica F7921	Pale Ash Nat Formica F1004	Elegant Oak Nat Formica F5374	Refined Walnut Nat Formica F5872	Dark Ash Nat Formica F8575	Kashmir Mat Formica F0187	Oyster Grey Mat Formica F7929	Pumice Mat Formica F7858	Olive Forbo Desktop 4184	Smokey Blue Forbo Desktop 4179	Burgundy Forbo Desktop 4154	Iron Forbo Desktop 4178	Beech M3227		
Allround	●	●	○	○	○	○	○	○	○	○	○	○	○	○	○	○	○	●		
u-Connect	●	●	○	○	○	○	○	○	○	○	○	○	○	○	○	○	○	●		
Eminent	●	●	○	○	○	○	○	○	○	○	○	○	○	○	○	○	○	●		
Standard Folding table	●	●	○	○	○	○	○	○	○	○	○	○	○					●		

## Kolory stelaży / Frame colours / Gestellfarbe

Legenda / Legend / Legende:

- Standardowy czas realizacji / Standard delivery time / Standardlieferzeit
- Wydłużony czas realizacji / Extended delivery time / Verlängerte Lieferzeit



	Snow RAL 9016	Misty Grey	Metalsilver	Steelgrey	Black RAL 9005/RAL9011	Polished aluminium
Allround	●		●	●	●	
u-Connect	●	●		●	●	○
Eminent	●		●	●	●	
Standard Folding table		●	●	●		

# Rozmiary blatów / Table top sizes / Plattenmaßen

Legenda / Legend / Legende:

- Standardowy czas realizacji / Standard delivery time / Standardlieferzeit
- Wydłużony czas realizacji / Extended delivery time / Verlängerte Lieferzeit
- Standard / Extended

cm	ø60	ø70	ø80	ø100	ø120	ø160	1/2 circle ø160	Ellipse 180 x 100	Trapezium 140x70x70x70, depth 60	80 x 80	90 x 60	120 x 45	120 x 60	120 x 70	120 x 80	120 x 90	140 x 60	140 x 70	140 x 80	160 x 70	160 x 80	180 x 70	180 x 80	180 x 90	
Allround	○	●	○	○	○			○		○				●	●			●	●			○	○	●	○
u-Connect													●	●	●			●	●	●	●	●	●	●	●
Eminent					○	○			○	○			●		●		○	●	●			●		●	
Standard Folding table							○				●	●	●	●	●	●	●	●	●	●	●	●	○	●	○



# Fabrics - Extended

Lead time 30-40 working days

- Legend: ● Possibility of making the product in the given upholstery  
 ○ Possibility of making only the seat in the given upholstery  
 □ No possibility of making the walls in the given upholstery  
 ◇ Handle always in fabric Next  
 - Impossibility of making a product in a given upholstery

	<b>Camira</b>										<b>Gabriel</b>											
	Blazer (PG 3)	Craggan Flax (PG 4)	Era (PG 3)	Gravity (PG 3)	Main Line Flax (PG 3)	Rivet (PG 3)	Nexus (PG 3)	Urban (PG 3)	X2 (PG 3)		Breeze Fusion (PG 4)	Chilli (PG 3)	Comfort+ (PG 5)	Crisp (PG 3)	Cyber (PG 3)	Fame (PG 3)	Focus (PG 3)	Focus Melange (PG 3)	Go_Check (PG 3)	Focus Royal (PG 3)	Gaja Classic (PG 3)	
Ana	●	●	●	●	●	●	●	●	●		●	●	●	●	-	●	●	●	●	●	●	●
Ariz	●	●	●	●	●	●	●	●	●		●	●	●	●	-	●	●	●	●	●	-	●
Bit	●	-	●	-	●	●	-	●	●		-	●	●	-	-	●	●	●	●	●	-	-
Chic	●	-	●	-	●	●	●	●	●		●	●	●	●	-	●	●	●	●	●	-	-
Chic Lounge	●	-	●	-	●	●	-	●	●		●	●	●	-	-	●	●	●	●	●	-	-
Com	●	-	●	-	●	●	●	●	●		●	●	●	●	-	●	●	●	●	●	-	-
Ellie <sup>Pro</sup>	●	-	●	-	●	●	-	●	●		●	●	-	●	-	●	●	●	●	●	-	-
Fan	●	-	●	●	●	●	●	●	●		●	●	●	●	-	●	●	●	●	●	-	●
Mickey	●	-	●	-	●	●	●	●	●		●	●	●	●	-	●	●	●	●	●	-	-
MyTurn Sofa	●	-	●	-	●	●	-	●	●		●	●	●	●	-	●	●	●	●	●	-	-
Noor	●	●	●	●	●	●	●	●	●		●	●	●	●	●	●	●	●	●	●	●	●
Noor F	●	-	-	-	●	-	●	-	●		-	●	-	-	●	●	●	●	●	●	●	●
Normo	●	-	●	-	●	●	-	●	●		●	●	●	●	-	●	●	●	●	●	-	-
Nu	●	-	●	-	●	●	●	●	●		●	●	●	●	-	●	●	●	●	●	-	●
October	●	●	●	-	●	●	●	●	●		-	●	●	-	-	●	●	●	●	●	-	-
Revo	●	-	●	-	●	●	-	●	●		●	●	●	-	-	●	●	●	●	●	-	-
Snap 20H	-	-	●	-	●	-	-	●	●		●	●	-	-	-	●	●	●	●	●	-	-
Snap 21H	-	-	●	-	●	-	-	●	●		●	●	-	-	-	●	●	●	●	●	-	-
SoftBox	●	-	●	-	●	●	●	●	●		●	●	●	●	-	●	●	●	●	●	-	-
Sorriso	●	-	●	-	●	●	●	●	●		-	●	●	●	-	●	●	●	●	●	-	●
Trillo <sup>Pro</sup>	●	-	●	-	●	●	-	●	●		-	●	●	-	-	●	●	●	●	●	-	-
Vancouver Lite	●	-	●	-	●	●	●	●	●		●	●	●	●	-	●	●	●	●	●	-	-
Vancouver Oto	●	-	●	●	●	●	●	●	●		●	●	●	●	-	●	●	●	●	●	-	●
Wall In	●	-	●	-	●	●	●	●	●		●	●	●	●	-	●	●	●	●	●	-	-
Zoo	●	-	●	-	●	●	●	●	●		-	●	●	-	-	●	●	●	●	●	-	-
Cushions	●	-	●	-	●	●	-	●	●		-	●	●	-	-	●	●	●	●	●	-	-

# Fabrics - Extended

Lead time 30-40 working days

Gaja C2C (PG 3)	Passion (PG 4)	Step Melange (PG 3)	GU											Kvadrat								
			Arndal (PG 4)	Bardal (PG 4)	Gandal + (PG 4)	Heidal (PG 4)	Hemsedal (PG 3)	Mandal (PG 4)	Morgedal (PG 4)	Setesdal (PG 4)	Sirdal (PG 4)	Suldal (PG 4)	Atlas (PG 3)	Canvas (PG 4)	Coda (PG 6)	Divina Melange (PG 5)	Divina (PG 5)	Divina MD(PG 5)	Flord 2 (PG 4)			
●	●	●	●	●	●	●	●	●	●	●	●	●	●	●	●	●	●	●	●	●	Ana	
●	-	●	●	●	●	●	●	-	●	●	●	●	●	●	-	●	●	●	-	●	Ariz	
-	-	●	-	-	-	-	-	-	-	-	-	-	●	●	-	●	●	-	-	●	Bit	
-	-	●	●	●	●	●	●	-	●	●	●	●	●	●	●	●	●	●	-	●	Chic	
-	-	●	●	●	●	●	●	-	●	●	●	●	●	●	●	-	●	●	-	●	Chic Lounge	
-	-	●	●	●	●	●	●	-	●	●	●	●	●	●	-	●	●	●	-	●	Com	
-	-	●	●	●	●	●	●	-	●	●	●	●	●	●	-	●	●	●	-	●	Ellie <sup>Pno</sup>	
-	-	●	●	●	●	●	●	-	●	●	●	●	●	●	●	●	●	●	-	●	Fan	
-	-	●	●	●	●	●	●	-	●	●	●	●	●	●	◇	◇	◇	●	-	●	Mickey	
-	-	●	●	●	●	●	●	-	●	●	●	●	●	●	●	●	●	●	-	●	MyTurn Sofa	
●	●	●	●	●	●	●	●	●	●	●	●	●	●	●	●	●	●	●	●	●	Noor	
●	-	●	●	●	-	●	●	-	●	●	●	●	-	-	●	●	●	●	●	●	Noor F	
-	-	●	●	●	●	●	●	-	●	●	●	●	●	●	●	●	●	●	-	●	Normo	
-	-	●	●	●	●	●	●	-	●	●	●	●	●	●	●	●	●	●	-	●	Nu	
-	-	●	-	-	-	-	-	-	-	-	-	-	●	●	●	●	●	-	-	●	October	
-	-	●	-	-	-	●	-	-	-	-	-	-	●	●	●	●	●	-	-	●	Revo	
-	-	●	-	-	-	-	-	-	-	-	-	-	●	●	●	●	●	●	-	●	Snap 20H	
-	-	●	-	-	-	-	-	-	-	-	-	-	-	●	●	●	●	●	-	●	Snap 21H	
-	-	●	●	●	●	●	●	-	●	●	●	●	●	●	●	●	●	●	-	●	SoftBox	
-	-	●	-	-	-	-	-	-	-	-	-	-	●	●	●	●	●	-	-	●	Sorriso	
-	-	●	-	-	-	-	-	-	-	-	-	-	●	●	-	●	●	-	-	●	Trillo <sup>Pno</sup>	
-	-	●	●	●	●	●	●	-	●	●	●	●	●	●	●	●	●	●	-	●	Vancouver Lite	
-	-	●	●	●	●	●	●	-	●	●	●	●	●	●	●	●	●	●	-	●	Vancouver Oto	
-	-	●	●	●	●	●	●	-	●	●	●	●	●	●	●	●	●	●	-	●	Wall In	
-	-	●	-	-	-	-	-	-	-	-	-	-	●	●	-	●	●	-	-	●	Zoo	
-	-	●	-	-	-	-	-	-	-	-	-	-	●	●	●	●	●	-	-	●	Cushions	

# Fabrics - Extended

Lead time 30-40 working days

- Legend: ● Possibility of making the product in the given upholstery  
 ○ Possibility of making only the seat in the given upholstery  
 ☒ No possibility of making the walls in the given upholstery  
 ◇ Handle always in fabric Next  
 - Impossibility of making a product in a given upholstery



























	Foss (PG 5)	Hallingdal 65 (PG 5)	Melange Nap (PG 4)	Navelli (PG 4)	Remix (PG 3)	Re-wood (PG 3)	Twill Weave (PG 5)	Tonus 4 (PG 5)	<b>Nevotex</b>	Illusion (PG 4)	Illusion Full Grain(PG 4)	<b>Oniro</b>	PUxx 1 (PG 3)	PUxx 2 (PG 3)	<b>Spradling</b>	Silvertex (PG 3)	Valencia (PG 1)	<b>Svensson</b>	Khaki (PG 3)	Node (PG 3)	Semi (PG 3)	Step (PG 3)
Ana	●	●	●	●	●	●	●	●		●	●		●	●		●	●		●	●	●	●
Ariz	●	●	●	-	●	●	●	●		○	-		○	○		●	●		●	-	●	●
Bit	-	-	●	-	●	●	●	-		-	-		-	-		●	●		-	-	●	-
Chic	-	●	●	-	●	●	●	●		-	-		-	-		●	●		-	-	●	-
Chic Lounge	-	●	●	-	●	●	●	●		-	-		-	-		-	-		-	-	●	-
Com	-	●	●	-	●	●	●	●		-	-		○	○		●	●		-	-	●	-
Ellie <sup>Pro</sup>	-	●	●	-	●	●	●	●		-	-		-	-		-	-		-	-	●	-
Fan	-	●	●	-	●	●	●	●		-	-		-	-		●	●		-	-	●	-
Mickey	-	●	●	-	●	●	●	●		-	-		-	-		◇	●		-	-	●	-
MyTurn Sofa	-	●	●	-	●	●	●	●		-	-		-	-		●	●		-	-	-	-
Noor	●	●	●	●	●	●	●	●		●	●		●	●		●	●		●	●	●	●
Noor F	-	●	●	-	-	●	●	-		-	-		-	-		-	-		-	●	●	●
Normo	-	●	●	-	●	●	●	●		-	-		-	-		-	-		-	-	●	-
Nu	●	●	●	-	●	●	●	●		-	-		-	-		●	●		-	-	●	-
October	-	-	●	-	●	●	●	-		-	-		-	-		●	●		-	-	●	-
Revo	-	-	●	-	●	●	●	-		-	-		-	-		●	●		-	-	●	-
Snap 20H	-	●	●	-	●	●	-	-		-	-		-	-		●	-		-	-	●	-
Snap 21H	-	●	●	-	●	●	-	-		-	-		-	-		-	-		-	-	●	-
SoftBox	-	●	●	-	●	●	●	●		-	-		-	-		☒	☒		-	-	●	-
Sorriso	-	-	●	-	●	●	●	●		-	-		-	-		●	●		-	-	●	-
Trillo <sup>Pro</sup>	-	-	●	-	●	●	●	-		-	-		-	-		●	●		-	-	●	-
Vancouver Lite	-	●	●	-	●	●	●	●		-	-		-	-		●	●		-	-	●	-
Vancouver Oto	-	●	●	-	●	●	●	●		-	-		-	-		●	●		-	-	●	-
Wall In	-	●	●	-	●	●	●	●		-	-		-	-		☒	☒		-	-	●	-
Zoo	-	-	●	-	●	●	●	-		-	-		-	-		●	●		-	-	●	-
Cushions	-	-	●	-	●	●	●	-		-	-		-	-		●	●		-	-	●	-

# Fabrics - Extended

Lead time 30-40 working days

	Ana
	Ariz
	Bit
	Chic
	Chic Lounge
	Com
	Ellie <sup>Pro</sup>
	Fan
	Mickey
	MyTurn Sofa
	Noor
	Noor F
	Normo
	Nu
	October
	Revo
	Snap 20H
	Snap 21H
	SoftBox
	Sorriso
	Trillo <sup>Pro</sup>
	Vancouver Lite
	Vancouver Oto
	Wall In
	Zoo
	Cushions

# Legend

 20,0	net weight		Ergonomie geprüft
 22,5	gross weight		GS (geprüfte Sicherheit)
 10	stacking (max. quantity)		Quality Office
 15	stacking on trolley for transportation (max. quantity)		MöBELFAKTA
	right-sided table top		The Blue Angel
	left-sided table top	<a href="http://www.blauer-engel.de/uz117">www.blauer-engel.de/uz117</a>	
	joining in rows		Forest Stewardship Council®
	two-colour upholstery		Environmental Product Declarations (EPD)
	teflon glides		GS (Intertek)
	felt glides		EU Ecolabel: PL/049/001
	special threads		
	clothes hanger		
	Mediaport		
	guarantee period		
	ISO 9001		
	ISO 14001		
	Chrom (III)		
	The mark of responsible forestry. Concerns only products indicated as FSC® certified.		

Social Media

Facebook

YouTube

Instagram

Pinterest

LinkedIn

Office

Flokk A/S

Sorgenfrivej 18

2800 Kongens Lyngby