



PRISLISTE

DKK - GYLDIG FRA 01.04.2024



DESIGNED FOR HUMAN PERFORMANCE

Content

General sales and delivery terms	3
RH Logic 200 /220 Silver	5
RH Logic 200/220 Black	8
RH Logic 300 - Udgår af prislisten i løbet af 2024	10
RH Logic 400 - Udgår af prislisten i løbet af 2024	13
RH Mereo Silver	16
RH Mereo Black	18
RH Mereo Silver Grey	20
RH Extend - Udgår af prislisten i løbet af 2024	22
RH Activ	24
RH Activ 300	27
RH Support	29
RH Secur24	31
RH Focus	34
RH Logic 400/300 ESD - Udgår af prislisten i løbet af 2024	36
RH Extend ESD - Udgår af prislisten i løbet af 2024	37
RH Activ ESD	38
RH Activ ESD Cleanroom	40
RH Activ Cleanroom	42
Spare parts	44
Standard Fabric & Colour Collection	50
Fabrics 24/7	58
Extended Fabric & Colour Collection	61
Flokk & Kvadrat Curated Collection	63
Fabric requirement	64
Physical measurements - Work chairs	65
Tests and Certificates	72
RH Quick-ship	73

General sales and delivery terms

This document applies for contracted distributors of RH in Denmark (including Faroe Islands and Greenland).

CUSTOMER SERVICE

Flokk A/S
Phone: +45 99 50 55 00
E-mail: info-dk@flokk.com

Flokk reserves the right to make small corrections alterations without notice.

STANDARD DELIVERY TIMES FROM FACTORY

RH Quick-ship	5 - 10 Working days
Standard Fabric & Colour Collection	10 - 15 Working days
Curated Fabric & Colour Collection	20 Working Days
Extended Fabric & Colour Collection	25 Working days*
On request	On request

STANDARD DELIVERY TIMES FOR RH SECURE24

RH Quick-ship	10 Working days
Standard Fabric & Colour Collection	23-28 Working days*
Extended Fabric & Colour Collection	30-35 Working days*
On request	On request

1-2 transport days to be added on top of production lead time.

* Provided that the supplier has the fabric in stock.

Transport-Days Must Be Added. Longer delivery times may occur periodically, during holidays and for large orders.

Order entry specification:

Please specify the following information when placing an order for RH products:

- Order number
- Model code/name
- Number of products
- Fabric/leather Colour Code
- Colour/paint on foot base/frame
- Type of castors or glides
- Type of gas lift
- Options. Eg. armrests, neckrest
- Desired delivery date
- Delivery address
- Project number (if any)

PRICES

All prices are recommended retail prices in DKK exclusive of VAT. Valid from 01.04.2024. Quotations are valid for 30 days unless otherwise agreed. Any typographical errors shall not be binding for Flokk and will be subject to correction without liability to the vendor.

Conditions of payment

Subject to local sales agreement. Interest charged for non-payment according to current terms. All goods remain the property of Flokk A/S until payment is made in full.

CONDITIONS OF DELIVERY

Ex Works (Incoterms 2020), including packaging. A 3% transportation & energy cost surcharge on the net order value will be applied to all orders with delivery terms agreed different from Ex Works.

Shipping fee of 5% of the net order value (min. DKK 250) is added on all orders, which is not delivered to addresses used or owned by the distributor.

Time specific delivery on a specific date and time indication costs DKK 5.000 per. order and must be ordered no later than five days before the sending date via Customer Service, Flokk A/S.

Visible transport damage and discrepancies in the number of items received must always be noted on the bill of carriage at the time of receipt and reported to the carrier and Customer Service, Flokk within 7 days after receipt.

Invisible damage (means no damaged packaging) must also be reported in writing to Customer Service, Flokk within 7 days after receipt.

For transport damage you need to take photos and document the damage, before reporting in writing to Customer Service, Flokk.

Please document:

- Photo of Flokk product label (including order no.)
- Photo of damaged goods
- Photo of damaged packaging
- Copy of transport document (if provided)
- Short description of claim

Damage in transit

Visible transport damage and discrepancies in the number of items received must always be noted on the bill of carriage at the time of receipt and reported to the carrier. The recipient/customer must also inform the supplier within 48 hours of receipt.

Invisible transport damage (damaged product, but not package) should be reported in writing to Customer Service, Flokk A/S within 7 days.

Change/cancellation of orders on chairs and upholsteries

Change/cancellation of orders on chairs or upholstery are possible up until production has begun. Changes made 2 days after receiving the order confirmation, each amended or cancelled order will incur a charge per order (see below).

Once production has started orders cannot be changed. Change of orders within the RH Quick-ship collection are not possible.

Each amended or cancelled order will incur a charge:

- Amended order (all changes & cancellations) before production start will incur a charge of 500 DKK per order
- Amended order & cancellations after purchasing has started will incur a charge of 750 DKK per order + cost of materials

For further information regarding change/cancellation of orders, please feel free to contact Customer Service, Flokk A/S.

GENERAL WARRANTY

Flokk's warranty covers all chairs against material and manufacturing faults and defects from the chair's production date. The warranty covers any necessary spare parts. Labour and transport costs are not covered. Wear and tear must be expected from normal use and are not covered by the warranty. Unless otherwise specified, the maximum weight for users is 150 kg/23.5 stones. The warranty is conditional on the chair and fabrics/leather undergoing normal cleaning.

10 year warranty for RH products

Flokk provides a 10 year warranty for all RH chairs that are used under normal conditions for up to 9 hours per day. For normal usage that exceeds 9 hours a day RH provides a 5 year warranty on all RH Chairs (covers chairs delivered after 01.02.2010).

24/7 - 3 year warranty (from production date 01.05.2022)

Flokk provides a 3 year warranty for RH chairs that are approved for control room or 24/7 use (RH Logic, RH Secur 24 & RH Focus). Upholstery is not covered under these terms unless its an RH approved 24/7 fabric.

>9 hours/day - 5 year warranty

Flokk provides a 5 year warranty for all RH chairs that are in normal use for more than 9 hours per day. Please also see the general warranty terms and conditions.

ESD/Cleanroom warranty

Flokk provides a 5 year warranty for ESD, ESD Cleanroom and Cleanroom finished chairs, conditional on castors and treads being cleaned regularly with a suitable cleaning agent.

Spare Part Guarantee

Flokk guarantees the deliver of spare parts for minimum of 10 years after the chairs´ s production date. The guarantee covers the parts needed to maintain the chairs´ s original functionally.

Upholstery

When seated, the foam in the seat pad is compressed, which may cause small wrinkles to occur. This is normal for this type of product. Wrinkles will partially disappear when the chair is not in use.

Standard fabric & colour collection

Flokk provides a 10 year warranty for fabrics/leather from the Standard Fabric & Colour Collection when the chair is in normal use for up to 9 hours per day. Flokk provides a 5 year warranty for fabrics/leather from the Standard Fabric & Colour Collection when the chair is in normal use for more than 9 hours per day. Except for Illusion and Puxx1 where a 5 year warranty is provided.

Fire classification

Foams and standard fabrics are tested to EN 1021-1&2 (cigarette & match). Foam and fabric according to BS-5852 ignition source 5 (crib 5) can be delivered on request at a surcharge of and must be specified at the time of order. Order of CMHR adds approximately two to five weeks to delivery lead times. CMHR foam must be specified on chairs intended for domestic use. Please contact Customer Services for further information.

Curated fabric & colour collection

Flokk provides a 10 year warranty for fabrics from the Curated collection when the chair is in normal use for up to 9 hours per day. Flokk provides a 5 year warranty for fabrics from the Curated Collection when the chair is in normal use for more than 9 hours per day.

NOTE! Some fabrics in our Collections may not be approved for all RH chairs, please contact our Customer Service, Flokk A/S for more information.

Extended fabric & colour collection

Flokk provides a 5 year warranty for fabrics/leather from the Extended Fabric & Colour Collection when the chair is in normal use for up to 9 hours per day. Some of the fabrics in the Extended Fabric & Colour Collection are available with a 5 year warranty for 24 hour use (for use of more than 9 hours per day).

Special fabrics/leather or customers own material (COM)

If the fabrics in the Standard, Curated or Extended collections are not what you are looking for, please contact Customer Service, Flokk A/S. When choosing Special or Customer specified fabric/leather the general warranty terms and conditions are still valid, except for the upholstery which will be without any warranty. This does not affect your rights and obligations under local law. Customer specified fabrics/leather can only be used following approval by Flokk. Fabrics and leathers that are not tested on our products, need to have an upholstery test before we can approve it and the order can be registered. Cost (DKK 1.545) for testing will be charged.

NOTE! For environmental reasons we don´t use any glue or fasteners in the upholstery process for some of our products. Therefore some fabric are not suitable for certain products, see information on the pages for Fabric Collections or contact our Customer Service for more information.

Maintenance guide

Care of Fabric upholstery: Regular vacuum cleaning is recommended. Marks and stains should be removed with a proprietary cleaner. Care of leather upholstery: Wipe with a slightly damp cloth and gently rub dry. A good proprietary hide food should be applied at least once a year and more often if the leather is in a dry atmosphere or close to a heat source.

For additional maintenance advice please contact our customer service team or website www.flokk.com.

QUALITY

Flokk is ISO 9001 certified. Most chair models are tested and approved in accordance with the most stringent European regulations including: Möbelfakta, EN 1335-1 (dimensions), BS/EN 1335-2 (safety, strength and durability). All measurements given in the price list are based on EN1335-1, hence measurements cannot be replicated without correct settings, methods and equipment. The seat height will vary in accordance with the weight of the user. Please contact us for further information or test reports.

Flokk disclaims any responsibility for products that are configured or assembled in a different way than Flokk's official configurations. That is, as a result of component purchases, special orders or the like.

ENVIRONMENTAL RESPONSIBILITY

Environmental considerations on our products and the manufacturing of our products are at the heart of our business. Most of the materials used in RH chairs can be recycled if handled properly. A complete material composition for each RH product and our environmental brochure are available on request. Flokk is certified in accordance with ISO 14001:2015 environment and ISO 50001:2018 energy management systems. The environmental life cycle impact of RH Logic 200/220, RH Logic 400/300, RH Mereo, RH Extend, RH Axia, RH Activ and RH Support is documented in the ISO 14025 Environmental Product Declarations (EPD). RH Logic 200/220, RH Logic 300/400, RH Mereo, RH Extend, RH Axia, RH Activ and RH Support are also GREENGUARD Gold certified

End of life - Recycling





We encourage you to ensure proper recycling of your chair and its various components. Please dispose of your chair/components using your local recycling partners/stations - and follow your local regulations. If you have questions on how to dispose or return your chair after use, please inform your contact person within Flokk.

Packaging material - Recycling

We encourage you to ensure recycling of all packaging material. Please sort and return the packaging material, using your local recycling partners/stations - and follow your local regulations. If you have questions on how to handle waste packaging material, please inform your contact person within Flokk.







RH Logic 200 /220 Silver

- Seat width: 442 mm, depth 477 mm (seatslide 100 mm)
- Seat height: 406-550 mm (4T NPR)
- Base in silver lacquered aluminium (5T) and castors for carpeted floors (Ø65 mm)
- Plastic colour: Black
- Lumbar pump is standard
- Certified in accordance to: EN 1335, GS, ANSIBIFMA X5.1, BS5459-2, Möbelfakta, EPD ISO 14025, GREENGUARD GOLD

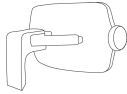
Item no	Base model +	Price Group (PG)	Price Group							Price
			①	②	③	④	⑤	⑥	⑦	
9111	RH Logic 200 Silver • Backrest medium: width 431 mm, height 518 mm • Weight: 19,9 kg		11 719	11 824	11 941	12 359	13 101	14 411	16 862	
9118	RH Logic 200 Silver Elite • Backrest medium: width 431 mm, height 518 mm • 20 mm extra foam in seat and back • Seat height: 426-570 mm (4T NPR) • Weight: 21 kg • This model is tested and approved for control room use		12 656	12 769	12 896	13 348	13 548	15 564	18 211	
9211	RH Logic 220 Silver • Backrest large: width 433 mm, height 620 mm • Weight: 20,4 kg		13 074	13 193	13 325	13 792	14 618	16 079	18 812	
9218	RH Logic 220 Silver Elite • Backrest large: width 433 mm, height 620 mm • 20 mm extra foam in seat and back • Seat height: 426-570 mm (4T NPR) • Weight: 22 kg • This model is tested and approved for control room use		14 120	14 248	14 391	14 895	15 787	16 798	20 317	
Accessories/Options/Surcharges:										
HR220	Neckrest RH Logic 200 Silver in fabric. Adjustable in height & depth								1 369	
HR221	Neckrest RH Logic 200 Silver in leather. Adjustable in height & depth								1 742	
BB200	Upholstered backshell								1 378	
SP242	Uniform upholstery of back and seat								0	
DS201	Decorative Stitching								905	
AR730	Armrest 8L Silver pair. Armrest top in TPU (black). Adjustable in height, depth, width & turnable								1 868	
AR731	Armrest 8L Silver pair for BS standard . Armrest top in TPU (black) . Adjustable in height, depth, width & turnable								1 868	
AR733	Armrest 8L Silver pair. Armrest top in leather (black). Adjustable in height, depth, width & turnable								2 487	
AR738	Armrest 8L XL Silver pair. Armrest top in TPU (black). Adjustable in height, depth, width & turnable								2 884	

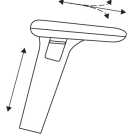
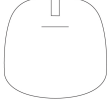
Accessories/Options/Surcharges:

AR741	Armrest traverse Silver. To supplement with armrest at a later stage	551
AE220	Coat hanger Logic 200	531
SE224	Seat XL, width 490 mm, depth 505 mm	1146
SP201	Coccyx seat only available for 9111 & 9211	1750
LI232	Gas stem A Silver	0
LI230	Gas stem B Silver	0
LI222	Gas stem 4T Silver	0
FB221	Footbase 5T Polished	698
CA201	Castors for hard floors, Ø65 mm, black	0
CA221	Castors manually lockable, Ø65 mm	337





Item no	Description	Accessories/Option	Item no	Description	Accessories/Option
HR220	Neckrest RH Logic 200 Silver in fabric. Adjustable in height & depth.		SP242	Uniform upholstery of back & seat. Fewer seams for a cleaner visual look.	
HR221	Neckrest RH Logic 200 Silver in leather. Adjustable in height & depth.		DS201	Decorative Stitching	
AR730	Armrest 8L Silver Armrest top in TPU (black) Height of armrest above seat 199-315 mm		SP201	Coccyx seat Seat with cut out for relief of the coccyx and lumbar spine. Only for model 9111 & 9211	
AR733	Armrest 8L Silver Armrest top in black leather (black) Height of armrest above seat 199-315 mm		FB221	Base 5T Polished, Ø680 mm, polished aluminium	
AR731	Armrest 8L Silver BS pair Armrest top in TPU (black) Height of armrest above seat 199-315 mm Select to accomplish BS5459-2				
AR738	Armrest 8L Silver XL Armrest top in black leather (black) width 135 mm, length 254 mm. Height of armrest above seat 199-315 mm				
SE224	Seat XL Width 490 mm, depth 505 mm				
AE220	Coat hanger in black plastic				
LI232	Gas stem A Silver Seat height 495-625 mm				
LI230	Gas stem B Silver Seat height 480-610 mm				
LI222	Gas stem 4T Silver Seat height 394-526 mm				

User Instruction RH Logic 200/220

Check out our user guide, explaining how each of the unique functions are adjusted. https://www.youtube.com/watch?v=_3wWOc2Gslg

RH Logic 200/220 Black

- Seat width: 442 mm, depth 477 mm (seatslide 100 mm)
- Seat height: 406-550 mm (4T NPR)
- Base in black lacquered aluminium (5T) and castors for carpeted floors (Ø65 mm)
- Plastic colour: Black
- Lumbar pump is standard
- Certified in accordance to: EN 1335, GS, ANSIBIFMA X5.1, BS5459-2, Möbelfakta, EPD ISO 14025, GREENGUARD GOLD





Item no	Base model +	Price Group (PG)	Price Group							Price
			①	②	③	④	⑤	⑥	⑦	
9112	RH Logic 200 Black • Backrest medium: width 431 mm, height 518 mm • Weight: 19,9 kg		11 719	11 824	11 941	12 359	13 101	14 411	16 862	
9119	RH Logic 200 Black Elite • Backrest medium: width 431 mm, height 518 mm • 20 mm extra foam in seat and back • Seat height: 426-570 mm (4T NPR) • Weight: 21 kg • This model is tested and approved for control room use		12 656	12 769	12 896	13 348	13 548	15 564	18 211	
9212	RH Logic 220 Black • Backrest large: width 433 mm, height 620 mm • Weight: 20,4 kg		13 074	13 193	13 325	13 792	14 618	16 079	18 812	
9219	RH Logic 220 Black Elite • Backrest large: width 433 mm, height 620 mm • 20 mm extra foam in seat and back • Seat height: 426-570 mm (4T NPR) • Weight: 22 kg • This model is tested and approved for control room use		14 120	14 248	14 391	14 895	15 787	16 798	20 317	

Accessories/Options/Surcharges:

HR218	Neckrest RH Logic 200 Black in fabric. Adjustable in height & depth	1 369
HR219	Neckrest RH Logic 200 Black in leather. Adjustable in height & depth	1 742
BB200	Upholstered backshell	1 378
SP242	Uniform upholstery of back and seat	0
DS201	Decorative Stitching	905
AR720	Armrest 8L Black pair. Armrest top in TPU (black). Adjustable in height, depth, width & turnable.	1 868
AR723	Armrest 8L Black pair. Armrest top in leather (black). Adjustable in height, depth, width & turnable.	2 487
AR721	Armrest 8L Black pair for BS standard . Armrest top in TPU (black) . Adjustable in height, depth, width & turnable.	1 868
AR728	Armrest 8L Black XL pair. Armrest top in leather (black). Adjustable in height, depth, width & turnable.	2 884

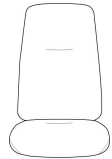
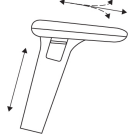
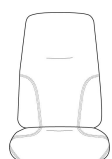
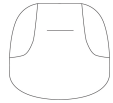
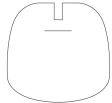
Accessories/Options/Surcharges:

AR740	Armrest traverse Black. To supplement with armrest at a later stage.	551
AE220	Coat hanger in black plastic	531
SE224	Seat XL, width 490 mm, depth 505 mm	1146
SP201	Coccyx seat only available for 9112 & 9212	1750
LI233	Gas stem A Black	0
LI231	Gas stem B Black	0
LI223	Gas stem 4T Black	0
FB221	Footbase 5T Polished	698
CA201	Castors for hard floors, Ø65 mm, black	0
CA221	Castors manually lockable, Ø65 mm	337

Item no	Description	Accessories/Option	Item no	Description	Accessories/Option
HR218	Neckrest RH Logic 200 Black in fabric. Adjustable in height & depth.		SP242	Uniform upholstery of back & seat. Fewer seams for a cleaner visual look.	
HR219	Neckrest RH Logic 200 Black in leather. Adjustable in height & depth.				
AR720	Armrest 8L Black Armrest top in TPU (black) Height of armrest above seat 199-315 mm		DS201	Decorative Stitching	
AR723	Armrest 8L Black Armrest top in black leather (black) Height of armrest above seat 199-315 mm				
AR721	Armrest 8L Black BS pair Armrest top in TPU (black) Height of armrest above seat 199-315 mm Select to accomplish BS5459-2				
AR728	Armrest 8L Black XL Armrest top in black leather (black) width 135 mm, length 254 mm, Height of armrest above seat 199-315 mm				
SE224	Seat XL Width 490 mm, depth 505 mm		SP201	Coccyx seat Seat with cut out for relief of the coccyx and lumbar spine. Only for model 9112 & 9212	
AE220	Coat hanger in black plastic		FB221	Base 5T Polished, Ø680 mm, polished aluminium	
LI233	Gas stem A Black Seat height 495-625 mm				
LI231	Gas stem B Black Seat height 480-610 mm				
LI223	Gas stem 4T Black Seat height 394-526 mm				

User Instruction RH Logic 200/220

Check out our user guide, explaining how each of the unique functions are adjusted. https://www.youtube.com/watch?v=_3wW0c2Gslg

RH Logic 300 - Udgår af prislisen i løbet af 2024

- Seat width: 462 mm, depth 467 mm (seatslide 80 mm)
- Backrest width: 447 mm, height 510 mm
- Seat height: 410-530 mm (4Q Silver)
- Base in silver aluminium (5X) and castors for carpeted floors (Ø65 mm)
- Lumbar pump is an optional extra on this model
- Neckrest Cassette - If ordering a RH Logic 300 without neckrest you must add a neckrest cassette in order to equip the chair with a neckrest at a later stage
- Certified in accordance to: EN 1335, BS5459-2, Möbelfakta, EPD ISO 14025, GREENGUARD GOLD, Nordic Swan

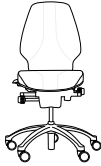
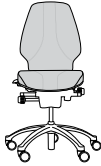
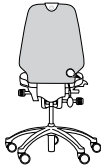
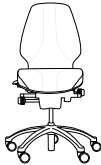
Item no	Base model +	Price Group (PG)	Price Group							Price
			①	②	③	④	⑤	⑥	⑦	
3340	RH Logic 300 Weight: 21 kg		11 339	11 443	11 615	12 014	12 701	13 959	16 331	
3343	RH Logic 300 Comfort • Extra padding with improved ventilation in seat and backpad • Weight: 21 kg		12 339	12 450	12 639	13 074	13 820	15 191	17 774	
3347	RH Logic 300 Elegance • Including upholstered backshell • Weight: 21 kg		12 473	12 587	12 777	13 214	13 970	15 355	17 966	
3349	RH Logic 300 Elite • 20 mm extra foam in seat and back with improved ventilation • Seat height: 430-550 mm (4Q silver) • This model is tested and approved for control room use • Weight: 21 kg		12 339	12 450	12 639	13 074	13 820	15 191	17 774	







Accessories/Options/Surcharges:

15022	Neckrest RH Logic 400 in fabric/C.O.M. Adjustable in height & depth	964
15032	Neckrest RH Logic 400 in leather. Adjustable in height & depth	1 447
15041	Neckrest Cassette for RH Logic 300 &Extend 100/200	85
DS201	Decorative Stitching	932
8300130-02	Armrest 8S pair (black). Adjustable in height, width & rotatable	1 623
8300230-02	Armrest 8S XL pair (black). Upholstered armrest top in black leather. Adjustable in height, width & rotatable	2 613
8700130-02	Armrest 8E pair (black). Adjustable in height, depth & width	1 694
8700280-02	Armrest 8E pair (black). Upholstered armrest top black leather. Adjustable in height, depth & width	2 489

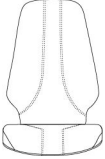
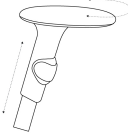
Accessories/Options/Surcharges:

111050-01	Coat hanger in black plastic	546
LP201	Lumbar pump	628
SE224	Seat XL, width 490 mm, depth 505 mm	1181
SP201	Coccyx seat	1750
SP202	Seat with memory foam (Only for: 3340, 3347)	3495
LI233	Gas stem A Black	0
LI232	Gas stem A Silver	0
LI231	Gas stem B Black	0
LI230	Gas stem B Silver	0
LI210	Gas stem 4Q Black	0
FB214	Base 5X Black, Ø660 mm, black lacquered aluminium	0
FB215	Base 5X Polished, Ø660 mm, polished aluminium	720
CA201	Castors for hard floors, Ø65 mm, black	0
CA221	Castors manually lockable, Ø65 mm	348

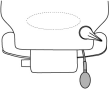
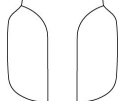
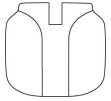
NOTE! To enable a neckrest to be fitted at a later stage, neckrest cassette must be added.

Item no	Description	Accessories/option	Item no	Description	Accessories/option
15022	Neckrest RH Logic 400 in fabric/C.O.M. Adjustable in height & depth		905005	Decorative Stitching	
15032	Neckrest RH Logic 400 in leather. Adjustable in height & depth				
8300130-02	Armrest 8S pair (black) Height of armrest above seat 198-299 mm		8700130-02	Armrest 8E pair (black) Height of armrest above seat 198-299 mm	
	RH Logic 300 Elite Height of armrest above seat 228-329 mm				
8300230-02	Armrest 8S XL pair (black). Upholstered armrest top in black leather. Height of armrest above seat 198-299 mm		8700280-02	Armrest 8E pair (black). Upholstered armrest top black leather. Height of armrest above seat 198-299 mm	
	RH Logic 300 Elite Height of armrest above seat 178-279 mm				
111050-01	Coat hanger in black plastic		LP201	Lumbar pump	
750235	Seat XL. Width 505 mm, depth 490 mm		SP201	Coccyx seat Seat with cut out for relief of the coccyx and lumbar spine.	
LI233	Gas stem A Black Seat height 495-625 mm		FB214	Base 5X Black, Ø660 mm, black lacquered aluminium	
LI232	Gas stem A Silver Seat height 495-625 mm				
LI231	Gas stem B Black Seat height 480-610 mm				
LI230	Gas stem B Silver Seat height 480-610 mm				
LI210	Gas stem 4Q Black Seat height 410-530 mm				
			FB215	Base 5X Polished, Ø660 mm, polished aluminium	

User Instruction RH Logic 400/300

Check out our user guide, explaining how each of the unique functions are adjusted. <https://www.youtube.com/watch?v=vM7s6RymQFs>

RH Logic 400 - Udgår af prislisen i løbet af 2024

- Seat: width 462 mm, depth 467 mm (seatslide 80 mm)
- Backrest with lumbar pump: width 447 mm, height 620 mm
- Seat height: 410-530 mm (4Q Silver)
- Base in silver aluminium (5X) and castors for carpeted floors (Ø65 mm)
- Certified in accordance to: EN 1335, BS5459-2, Möbelfakta, EPD ISO 14025, GREENGUARD GOLD, Nordic Swan

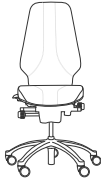
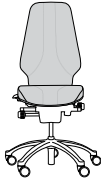
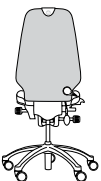
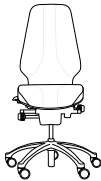





Item no	Base model +	Price Group (PG)	Price Group							Price
			①	②	③	④	⑤	⑥	⑦	
3550	RH Logic 400 Weight: 21,8 kg		13 355	13 477	13 681	14 153	14 959	16 444	19 240	
3553	RH Logic 400 Comfort • Extra padding with improved ventilation in seat and backpad • Weight: 21,8 kg		14 532	14 663	14 882	15 396	16 274	17 887	20 929	
3557	RH Logic 400 Elegance • Including upholstered backshell • Weight: 21,8 kg		14 766	14 897	15 123	15 643	16 537	18 176	21 266	
3559	RH Logic 400 Elite • 20 mm extra foam in seat and back with improved ventilation • Seat height 430-550 mm (4Q silver) • This model is tested and approved for control room use • Weight: 22,8 kg		14 532	14 663	14 882	15 396	16 274	17 887	20 929	

Accessories/Options/Surcharges:

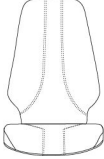
15022	Neckrest RH Logic 400 in fabric/C.O.M. Adjustable in height & depth	964
15032	Neckrest RH Logic 400 in leather. Adjustable in height & depth	1 447
DS201	Decorative Stitching	932
8300130-02	Armrest 8S pair (black). Adjustable in height, width & rotatable	1 623
8300230-02	Armrest 8S XL pair (black). Upholstered armrest top in black leather. Adjustable in height, width & rotatable	2 613
8700130-02	Armrest 8E pair (black). Adjustable in height, depth & width	1 694
8700280-02	Armrest 8E pair (black). Upholstered armrest top black leather. Adjustable in height, depth & width	2 489
111050-01	Coat hanger in black plastic	546
SE224	Seat XL, width 490 mm, depth 505 mm	1 181

Accessories/Options/Surcharges:

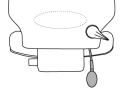
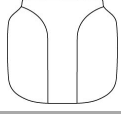
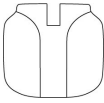
SP201	Coccyx seat	1 750
SP202	Seat with memory foam (Only for: 3550, 3557)	3 495
LI233	Gas stem A Black	0
LI232	Gas stem A Silver	0
LI231	Gas stem B Black	0
LI230	Gas stem B Silver	0
LI210	Gas stem 4Q Black	0
FB214	Base 5X Black, Ø660 mm, black lacquered aluminium	0
FB215	Base 5X Polished, Ø660 mm, polished aluminium	720
CA201	Castors for hard floors, Ø65 mm, black	0
CA221	Castors manually lockable, Ø65 mm	348

Item no	Description	Accessories/option	Item no	Description	Accessories/option
15022	Neckrest RH Logic 400 in fabric/C.O.M. Adjustable in height & depth		905005	Decorative Stitching	
15032	Neckrest RH Logic 400 in leather. Adjustable in height & depth				
8300130-02	Armrest 8S pair (black) Height of armrest above seat 198-299 mm RH Logic 400 Elite Height of armrest above seat 178-279 mm		8700130-02	Armrest 8E pair (black) Height of armrest above seat 198-299 mm RH Logic 400 Elite Height of armrest above seat 178-279 mm	
8300230-02	Armrest 8S XL pair (black). Upholstered armrest top in black leather. Height of armrest above seat 198-299 mm RH Logic 400 Elite Height of armrest above seat 178-279 mm		8700280-02	Armrest 8E pair (black). Upholstered armrest top in black leather Height of armrest above seat 198-299 mm RH Logic 400 Elite Height of armrest above seat 178-279 mm	
111050-01	Coat hanger in black plastic		-	Lumbar pump Standard on all RH Logic 400 models	
750235	Seat XL. Width 505 mm, depth 490 mm		SP201	Coccyx seat Seat with cut out for relief of the coccyx and lumbar spine.	
LI233	Gas stem A Black Seat height 495-625 mm		FB214	Base 5X Black, 660 mm, black lacquered aluminium	
LI232	Gas stem A Silver Seat height 495-625 mm				
LI231	Gas stem B Black Seat height 480-610 mm		FB215	Base 5X Polished, 660 mm, polished aluminium	
LI230	Gas stem B Silver Seat height 480-610 mm				
LI210	Gas stem 4Q Black Seat height 400-544 mm				

User Instruction RH Logic 400/300

Check out our user guide, explaining how each of the unique functions are adjusted. <https://www.youtube.com/watch?v=vM7s6RymQFs>

RH Mereo Silver

- Seat: width 407 mm, depth 470 mm (seatslide 100 mm)
- Seat height: 395-525 mm (4T NPR Silver)
- Base in silver lacquered aluminium (5T) and castors for carpeted floors (Ø65 mm)
- Plastic colour: Black
- Certified in accordance to: EN 1335, GS, ANSI/BIFMA X5-1, Möbelfakta, EPD ISO 14025, GREENGUARD GOLD

Item no	Base model +	Price Group (PG)	Price Group							Price
			①	②	③	④	⑤	⑥	⑦	
8111	RH Mereo 200 Silver • Backrest medium: width 365 mm, height 470 mm • Weight: 18,4 kg		8 529	8 606	8 734	9 036	9 554	10 499	12 283	
8211	RH Mereo 220 Silver • Backrest large: width 365 mm, height 630 mm • Weight: 18,9 kg		9 055	9 138	9 276	9 592	10 141	11 148	13 043	
8311	RH Mereo 300 Silver • Backrest large: width 442 mm, height 630 mm • Weight: 18,9 kg		9 146	9 229	9 322	9 651	10 226	11 249	13 161	

Accessories/Options/Surcharges:

730006-1	Neckrest RH Mereo in fabric/C.O.M Silver (only for 8211, 8311). Adjustable in height, depth and angle	1 173
730016-1	Neckrest RH Mereo in leather Silver (only for 8211, 8311). Adjustable in height, depth and angle	1 440
SE274	Seat XL RH Mereo from 2022	1 061
DS201	Decorative Stitching	932
SP233	RH Mereo Duo. Combination of two fabrics	932
730019-1	Armrest 8T pair Silver. Adjustable in height, depth, width & turnable.	1 566
AR705	Armrest 8T XL Silver pair. Adjustable in height, depth, width & turnable	2 411
730030-1	Armrest traverse Silver. To supplement with armrests at a later stage	568
730014-1	Coat hook in silver metal (only for 8211, 8311, 8213, 8313)	187
730015-1	Coat hanger in silver metal (only for 8211, 8311, 8213, 8313)	465
LI232	Gas stem A Silver	0
LI230	Gas stem B Silver	0
LI222	Gas stem 4T Silver	0
FB221	Footbase 5T Polished	719
CA201	Castors for hard floors, Ø65 mm, black	0

Accessories/Options/Surcharges:

CA220	Castors soft wheels for hard floors, Ø65 mm, grey	0
CA221	Castors manually lockable, Ø65 mm	348
CA222	Castor 75mm univer. freeroll (Only for: 8111, 8211)	191



Item no	Description	Accessories/option	Item no	Description	Accessories/option
730006-1	Neckrest RH Mereo Silver in fabric/C.O.M (only for 8211, 8311) Adjustable in height, depth & angle		905005	Decorative Stitching	
730016-1	Neckrest RH Mereo Silver in leather. (only for 8211, 8311) Adjustable in height, depth & angle				
730019-1	Armrest 8T Silver pair. Height of armrest above seat 195-310 mm		905008	RH Mereo Duo. Combination of two fabrics	
AR705	Armrest 8T XL Silver pair. Armrest top in black leather (black) width 135 mm, length 254 mm, Height of armrest above seat 195-310 mm				
SE274	Seat XL Width 490 mm, depth 520 mm		730015-1	Coat hanger in Silver metal (only for 8211, 8311, 8213, 8313)	
			730014-1	Coat hook in silver metal (only for 8211, 8311, 8213, 8313)	
LI232	Gas stem A Silver Seat height 495-625 mm		FB221	Base 5T Polished, Ø680 mm, polished aluminium	
LI230	Gas stem B Silver Seat height 480-610 mm				
LI222	Gas stem 4T Silver Seat height 388-520 mm				

User Instruction RH Mereo

Check out our user guide, explaining how each of the unique functions are adjusted. <https://www.youtube.com/watch?v=rN2R1H-6ZIk>







RH Mereo Black

- Seat: width 407 mm, depth 470 mm (seatslide 100 mm)
- Seat height: 395-525 mm (4T NPR Black)
- Base in black lacquered aluminium (5T) and castors for carpeted floors (Ø65 mm)
- Plastic colour: Black
- Certified in accordance to: EN 1335, GS, ANSI/BIFMA X5-1, Möbelfakta, EPD ISO 14025, GREENGUARD GOLD

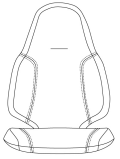
Item no	Base model +	Price Group (PG)	Price						
			①	②	③	④	⑤	⑥	⑦
8112	RH Mereo 200 Black • Backrest medium: width 365 mm, height 470 mm • Weight: 18,4 kg		8 529	8 606	8 734	9 036	9 554	10 499	12 283
8212	RH Mereo 220 Black • Backrest large: width 365 mm, height 630 mm • Weight: 18,9 kg		9 055	9 138	9 276	9 592	10 141	11 148	13 043
8312	RH Mereo 300 Black • Backrest large: width 400 mm, height 630 mm • Weight: 18,9 kg		9 146	9 229	9 322	9 651	10 226	11 249	13 161

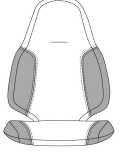
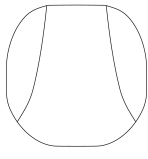
Accessories/Options/Surcharges:

730006-2	Neckrest RH Mereo in fabric/C.O.M Black (only for 8312, 8212). Adjustable in height, depth and angle	1 173
730016-2	Neckrest RH Mereo in leather Black (only for 8312, 8212). Adjustable in height, depth and angle	1 440
SE274	Seat XL RH Mereo from 2022	1 061
DS201	Decorative Stitching	932
SP233	RH Mereo Duo. Combination of two fabrics	932
730019-2	Armrest 8T Black pair. Adjustable in height, depth, width & turnable	1 566
AR707	Armrest 8T XL Black pair. Adjustable in height, depth, width & turnable	2 411
730030-2	Armrest traverse Black. To supplement with armrests at a later stage	568
730014-2	Coat hook in black metal (only for 8212, 8312)	187
730015-2	Coat Hanger in black metal (only for 8212, 8312)	465
LI233	Gas stem A Black	0
LI231	Gas stem B Black	0
LI223	Gas stem 4T Black	0
FB221	Footbase 5T Polished	719
CA201	Castors for hard floors, Ø65 mm, black	0
CA221	Castors manually lockable, Ø65 mm	348



Item no	Description	Accessories/option	Item no	Description	Accessories/option
730006-2	Neckrest RH Mereo Black in fabric/C.O.M (only for 8212, 8312). Adjustable in height, depth & angle		905005	Decorative Stitching	
730016-2	Neckrest RH Mereo Black in leather (only for 8212, 8312). Adjustable in height, depth & angle				
730019-2	Armrest 8T Black pair. Height of armrest above seat 195-310 mm		905008	RH Mereo Duo. Combination of two fabrics	
AR707	Armrest 8T XL Black pair . Armrest top in black leather (black) width 135 mm, length 254 mm, Height of armrest above seat 195-310 mm				
SE274	Seat XL Width 490 mm, depth 520 mm		730015-2	Coat Hanger in black metal (only for 8212, 8312)	
			730014-2	Coat hook in black metal (only for 8212, 8312)	
LI233	Gas stem A Black Seat height 495-625 mm		FB221	Base 5T Polished, Ø680 mm, polished aluminium	
LI231	Gas stem B Black Seat height 480-610 mm				
LI233	Gas stem 4T Black Seat height 388-520 mm				

User Instruction RH Mereo

Check out our user guide, explaining how each of the unique functions are adjusted. <https://www.youtube.com/watch?v=rN2R1H-6ZIk>

RH Mereo Silver Grey

- Seat: width 407 mm, depth 470 mm (seatslide 100 mm)
- Seat height: 395-525 mm (4T NPR Silver)
- Base in silver lacquered aluminium (5T) and castors for carpeted floors (Ø65 mm)
- Plastic colour: Grey
- Certified in accordance to: EN 1335, GS, ANSI/BIFMA X5-1, Möbelfakta, EPD ISO 14025, GREENGUARD GOLD

Item no	Base model +	Price Group (PG)	Price Group							Price
			①	②	③	④	⑤	⑥	⑦	
8113	RH Mereo 200 Silver Grey • Backrest medium: width 365 mm, height 470 mm • Weight: 18,4 kg		8 600	8 701	8 911	9 218	9 743	10 711	12 533	
8213	RH Mereo 220 Silver Grey • Backrest large: width 365 mm, height 630 mm • Weight: 18,9 kg		9 234	9 321	9 461	9 791	10 344	11 370	13 302	
8313	RH Mereo 300 Silver Grey • Backrest large: width 400 mm, height 630 mm • Weight: 18,9 kg		9 329	9 414	9 508	9 842	10 535	11 476	13 428	

Accessories/Options/Surcharges:







730006-3	Neckrest RH Mereo Silver Grey in fabric/C.O.M (only for 8213, 8313). Adjustable in height, depth and angle	1 187
730016-3	Neckrest RH Mereo Silver Grey in leather(only for 8213, 8313). Adjustable in height, depth and angle	1 453
SE274	Seat XL RH Mereo from 2022	1 061
DS201	Decorative Stitching	932
SP233	RH Mereo Duo. Combination of two fabrics	932
730019-3	Armrest 8T Silver Grey pair. Adjustable in height, depth, width & turnable	1 613
AR709	Armrest 8T XL Silver Grey pair. Adjustable in height, depth, width & turnable	2 483
730030-3	Armrest traverse Silver Grey. To supplement with armrests at a later stage	571
730014-1	Coat hook in silver metal (only for 8211, 8311, 8213, 8313)	187
730015-1	Coat hanger in silver metal (only for 8211, 8311, 8213, 8313)	465
LI232	Gas stem A Silver	0
LI230	Gas stem B Silver	0
LI222	Gas stem 4T Silver	0
FB221	Footbase 5T Polished	719
CA201	Castors for hard floors, Ø65 mm, black	0
CA220	Castors soft wheels for hard floors, Ø65 mm, grey	0

Accessories/Options/Surcharges:

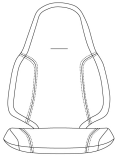
CA221

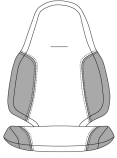
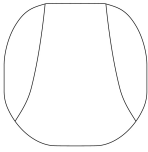
Castors manually lockable, Ø65 mm

348





Item no	Description	Accessories/option	Item no	Description	Accessories/option
730006-3	Neckrest RH Mereo Silver Grey in fabric/C.O.M (only for 8213, 8313). Adjustable in height, depth & angle		905005	Decorative Stitching	
730016-3	Neckrest RH Mereo Silver Grey in leather (only for 8213, 8313). Adjustable in height, depth & angle				
730019-3	Armrest 8T Silver Grey pair. Height of armrest above seat 195-310 mm		905008	RH Mereo Duo. Combination of two fabrics	
AR709	Armrest 8T XL Silver Grey pair. Armrest top in black leather (black) width 135 mm, length 254 mm, Height of armrest above seat 195-310 mm				
SE274	Seat XL Width 490 mm, depth 520 mm		730015-1	Coat hanger in silver metal (only for 8213, 8313)	
			730014-1	Coat hook in silver metal (only for 8213, 8313)	
LI232	Gas stem A Silver Seat height 495-625 mm		FB221	Base 5T Polished, Ø680 mm, polished aluminium	
LI230	Gas stem B Silver Seat height 480-610 mm				
LI222	Gas stem 4T Silver Seat height 388-520 mm				

User Instruction RH Mereo

Check out our user guide, explaining how each of the unique functions are adjusted. <https://www.youtube.com/watch?v=rN2R1H-6ZIk>

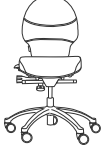
RH Extend - Udgår af prislisen i løbet af 2024

- Seat: width 461 mm, depth 465 mm (seatslide 80 mm)
- Seat height: 420-534 mm (4Q Silver)
- Base in silver lacquered aluminium (5X) and castors for carpeted floors (Ø65 mm)
- Certified in accordance to: EN 1335, GS, Möbelfakta, EPD ISO 14025, GREENGUARD GOLD

Item no	Base model +	Price Group (PG)	Price Group							Price
			①	②	③	④	⑤	⑥	⑦	
6111	RH Extend 100 • Backrest medium: width 440 mm, height 510 mm • Weight: 19 kg		8 059	8 131	8 255	8 539	9 024	9 918	11 606	
6211	RH Extend 120 • Backrest large: width 440 mm, height 620 mm • Weight: 19,8 kg		8 644	8 724	8 853	9 160	9 685	10 642	12 451	
6112	RH Extend 200 • Adjustable back angle • Backrest medium: width 440 mm, height 510 mm • Weight: 19 kg		9 772	9 860	10 006	10 352	10 945	12 029	14 073	
6212	RH Extend 220 • Adjustable back angle • Backrest large: width 440 mm, height 620 mm • Weight: 19,8 kg		10 357	10 453	10 609	10 974	11 601	12 751	14 919	







Accessories/Options/Surcharges:

100023	Neckrest RH Extend. Upholstered in Xtreme 009. Adjustable in height & depth	1 525
100023-01	Neckrest RH Extend in fabric/C.O.M. Adjustable in height & depth	1 895
100023-02	Neckrest RH Extend in leather. Adjustable in height & depth	2 036
15041	Neckrest Cassette for RH Logic 300 & Extend 100/200	85
750236	Seat XL, width 490 mm, depth 505 mm	1 070
DS201	Decorative Stitching	932
	Uniform upholstery back	819
	Uniform upholstery seat	819
8300130-02	Armrest 8S pair (black). Adjustable in height, width & rotatable	1 623
8700130-02	Armrest 8E pair (black). Adjustable in height, depth & width	1 694

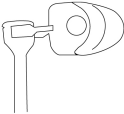
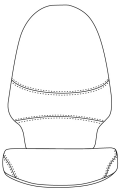
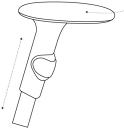
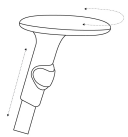
Accessories/Options/Surcharges:

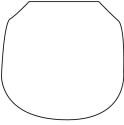
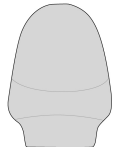
8700280-02	Armrest 8E pair (black). Upholstered armrest top black leather. Adjustable in height, depth & width	2 489
111050-01	Coat hanger in black plastic	546
LI201	Gas stem 4P Black	0
LI200	Gas stem 4P Silver	0
LI210	Gas stem 4Q Black	0
FB214	Base 5X Black, Ø660 mm, black lacquered aluminium	0
FB215	Base 5X Polished, Ø660 mm, polished aluminium	720
CA201	Castors for hard floors, Ø65 mm, black	0

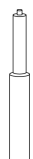
NOTE: To enable a neckrest to be fitted at a later stage, you "must" add a neckrest cassette. Only for RH Extend 100 and 200.





Item no	Description	Accessories/option	Item no	Description	Accessories/option
100023	Neckrest RH Extend. Upholstered in Xtreme 009. Adjustable in height & depth		905005	Decorative Stitching	
100023-01	Neckrest RH Extend in fabric/C.O.M. Adjustable in height & depth				
100023-02	Neckrest RH Extend in leather. Adjustable in height & depth				
8300130-02	Armrest 8S pair (black). Adjustable in height, width & rotatable Height of armrest above seat 220-297 mm		8700130-02	Armrest 8E pair (black). Adjustable in height, depth & width Height of armrest above seat 220-297 mm	
111050-01	Coat hanger in black plastic		8700280-02	Armrest 8E pair (black). Upholstered armrest top black leather. Adjustable in height, depth & width Height of armrest above seat 220-297 mm	
750236	Seat XL. Width 490 mm, depth 505 mm		-	Uniform upholstery back. Upholstery without contrasted black waist for a cleaner visual look.	
			-	Uniform upholstery seat Upholstery without contrasted black sides for a cleaner visual look.	
LI201	Gas stem 4P Black Seat height 440-550 mm		FB214	Base 5X Black, Ø660 mm, black lacquered aluminium	
LI200	Gas stem 4P Silver Seat height 440-550 mm		FB215	Base 5X Polished, Ø660 mm, polished aluminium	
LI210	Gas stem 4Q Black Seat height 420-534 mm				

User Instruction RH Extend

Check out our user guide, explaining how each of the unique functions are adjusted. <https://www.youtube.com/watch?v=0F0aJG1JbdI>

RH Activ

- Seat height: 392-522 mm (B Black)
- Base in black lacquered aluminium (5F) and castors for carpeted floors (Ø50 mm)
- Certified in accordance to: EN 1335, BS5459, Möbelfakta, EPD ISO 14025, GREENGUARD GOLD

Item no	Base model +	Price Group (PG)	Price Group							Price
			①	②	③	④	⑤	⑥	⑦	
2772	RH Activ 200 • Backrest medium: width 370 mm, height 295 mm • Seat medium: width 440 mm, depth 430 mm (seatslide 55 mm) • Weight: 13 kg		5 844	5 895	5 984	6 191	6 544	7 191	8 414	
2872	RH Activ 220 • Backrest large: width 370 mm, height 430 mm • Seat medium: width 440 mm, depth 430 mm (seatslide 55 mm) • Weight: 13,6 kg		6 235	6 290	6 384	6 607	6 983	7 676	8 981	
2782	RH Activ 202 • Backrest medium: width 370 mm, height 295 mm • Seat medium: width 460 mm, depth 460 mm (seatslide 55 mm) • Weight: 13 kg		6 180	6 236	6 330	6 548	6 923	7 607	8 900	
2882	RH Activ 222 • Backrest large: width 370 mm, height 430 mm • Seat large: width 460 mm, depth 460 mm (seatslide 55 mm) • Weight: 13,6 kg		6 574	6 635	6 735	6 965	7 364	8 093	9 469	

Accessories/Options/Surcharges:









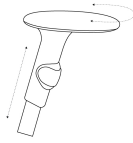

8300130-02	Armrest 8S pair (black). Adjustable in height, width & rotatable	1 623
8700130-02	Armrest 8E pair (black). Adjustable in height, depth & width	1 694
8700280-02	Armrest 8E pair (black). Upholstered armrest top black leather. Adjustable in height, depth & width	2 489
RB200	Reinforced upper part backpad (black leather)	398
RS200	Reinforced front edge seat (black leather)	398
SE212	Seat cashier medium (30 mm extra padding)	590
63100-01	Footring 6F, black, Ø455 mm	916
LI233	Gas stem A Black	0
LI232	Gas stem A Silver	0
LI230	Gas stem B Silver	0
LI235	Gas stem D Black	81

Accessories/Options/Surcharges:

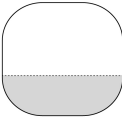
LI234	Gas stem D Silver	81
LI237	Gas stem E Black	224
LI236	Gas stem E Silver	224
LI228	Gas stem 4FL Black	0
FB225	Base 5F Silver, Ø590 mm, silver lacquered aluminium	0
FB227	Base 5F Polished, Ø590 mm, polished aluminium	904
FB229	Base 5G Black, Ø630 mm, black lacquered aluminium	189
FB228	Base 5G Silver, Ø630 mm, silver lacquered aluminium	189
FB230	Base 5G Polished, Ø630 mm, polished aluminium	1090
FB210	Base 5N - Ø540 mm, polished steel, for castors 7HN, 7D or 7G increases seat height 25 mm	313
CA206	Castors for hard floors, Ø50 mm, black	0
CA211	Castors 7D for carpeted floors, Ø50 mm. For base 5N	0
CA207	Castors 7G, locks automatically when seated, Ø50 mm	280
CA212	Castors 7HN for hard floors, Ø50 mm. For base 5N	0
CA208	Plastic glide 7K	0

VALID COMBINATIONS

Model: 2772 & 2782	
Base: 5N	Gas stem: 4FL, B
Base: 5F	Gas stem: 4FL, B, A, D, E
Base: 5G	Gas stem: 4FL, B, A, D, E
Model: 2882, 2872	
Base: 5F	Gas stem: 4FL, B
Base: 5G	Gas stem: 4FL, B, A, D, E



Item no	Description	Accessories/option	Item no	Description	Accessories/option
8300130-02	Armrest 8S pair (black). Adjustable in height, width & rotatable. Armrest height above seat 190-290 mm		8700130-02	Armrest 8E pair (black). Adjustable in height, depth & width. Armrest height above seat 190-290 mm	
SE212	Seat cashier medium (30 mm extra padding)		8700280-02	Armrest 8E pair (black). Upholstered armrest top black leather. Adjustable in height, depth & width. Armrest height above seat 190-290 mm	
RB200	Reinforced upper part backpad (black leather)		RS200	Reinforced front edge seat (black leather)	
63100-01	Footring 6F, black, Ø455 mm		71810	Plastic glide 7K	
LI233	Gas stem A Black Seat height 437-573 mm		FB225	Base 5F Silver, Ø590 mm, silver lacquered aluminium	
LI232	Gas stem A Silver Seat height 437-573 mm		FB227	Base 5F Polished, Ø590 mm, polished aluminium	
LI230	Gas stem B Silver Seat height 392-522 mm		FB229	Base 5G Black, Ø630 mm, black lacquered aluminium	
LI235	Gas stem D Black Seat height 590-680 mm		FB228	Base 5G Silver, Ø630 mm, silver lacquered aluminium	
LI234	Gas stem D Silver Seat height 590-680 mm		FB230	Base 5G Polished, Ø630 mm, polished aluminium	
LI237	Gas stem E Black Seat height 600-850 mm		FB210	Base 5N - Ø540 mm, polished steel	
LI236	Gas stem E Silver Seat height 600-850 mm				
LI228	Gas stem 4FL Black Seat height 370-460 mm				

User Instruction RH Activ

Check out our user guide, explaining how each of the unique functions are adjusted. <https://www.youtube.com/watch?v=hexc6goUIM4>

RH Activ 300

- Seat height: 500-680 mm (D Grey)
- Backrest: width 280 mm, height 230 mm
- All metal parts in dark grey lacquer (RAL 7024), all plastic parts in dark grey (MT 11310)
- Base in dark grey lacquered aluminium (5F) and castors that lock automatically when seated (50mm)
- Certified in accordance to: ANSI/BIFMA, GS





Item no	Base model +	Price Group (PG)	Price Group							Price
			①	②	③	④	⑤	⑥	⑦	
2678	RH Activ 301 • Seat medium: width 440 mm, depth 430 mm (seatslide 50 mm) • Weight: 13 kg		6 408	6 467	6 565	6 791	7 180	7 888	9 229	
2688	RH Activ 302 • Seat large: width 460 mm, depth 460 mm (seatslide 50 mm) • Weight: 13,6 kg		6 632	6 692	6 792	7 025	7 429	8 164	9 553	
2668-01	RH Activ 303 • Seat Cashier: width 450 mm, depth 428 mm (extra padding, 30 mm) (seatslide 50 mm) • Seat height: 515-700 mm • Weight: 13 kg		6 880	6 945	7 049	7 291	7 706	8 470	9 910	

Accessories/Options/Surcharges:

RB200	Reinforced upper part backpad (black leather)	398
RS200	Reinforced front edge seat (black leather)	398
63100-01	Footring 6F, black, Ø455 mm	916
LI254	Gas stem A Grey (RAL 7024)	0
LI237	Gas stem E Black	224
FB227	Base 5F Polished, Ø590 mm, polished aluminium	904
FB229	Base 5G Black, Ø630 mm, black lacquered aluminium	189
FB230	Base 5G Polished, Ø630 mm, polished aluminium	1 090
CA206	Castors for hard floors, Ø50 mm, black	0
CA205	Castors for soft floors, Ø50 mm, black	0
CA208	Plastic glide 7K	0

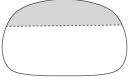
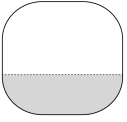
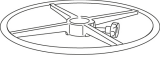

NOTE!

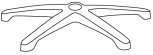
RH Activ 301, 302, 303 with gas stem E only in combination with base 5G

Item no	Description	Accessories/option	Item no	Description	Accessories/option
RB200	Reinforced upper part backpad (black leather)		RS200	Reinforced front edge seat (black leather)	
63100-01	Footring 6F, black, Ø455 mm		CA208	Plastic glide 7K	
LI254	Gas stem A Grey (RAL 7024) Seat height 437-573 mm		FB227	Base 5F Polished, Ø590 mm, polished aluminium	
LI237	Gas stem E Black Seat height 600-850 mm		FB229	Base 5G Black, Ø630 mm, black lacquered aluminium	
			FB230	Base 5G Polished, Ø630 mm, polished aluminium	

RH Support

- Base in black lacquered aluminium (5F- Ø590 mm) and glides (7K)
- Certified in accordance to: EPD ISO 14025, GREENGUARD GOLD

Item no	Base model +	Price Group (PG)	①	②	③	④	⑤	⑥	⑦	Price
4501	RH Support 4501 • Backrest RH17: width 380 mm, height 230 mm • Seat RH8 Saddle: width 410 mm, depth 380 mm • Mechanism: 3G • Seat height: 565-810 mm (E Black) • Weight: 10,6 kg		5 298	5 344	5 426	5 612	5 934	6 521	7 631	
4511	RH Support 4511 • Backrest RH17: width 380 mm, height 230 mm • Seat RH9 Taburet: Ø350 mm • Mechanism: 3G • Seat height: 580-825 mm (E Black) • Weight: 10,5 kg		5 156	5 201	5 279	5 462	5 773	6 344	7 424	
4521	RH Support 4521 • Backrest RH17: width 380 mm, height 230 mm • Seat RH7 Limpan: width 450 mm, depth 240 mm • Mechanism: 3G • Seat height: 565-810 mm (E Black) • Weight: 10,5 kg		5 130	5 175	5 252	5 434	5 744	6 313	7 387	
Accessories/Options/Surcharges:										
LI233	Gas stem A Black									- 224
LI232	Gas stem A Silver									- 224
LI231	Gas stem B Black									- 224
LI230	Gas stem B Silver									- 224
LI235	Gas stem D Black									- 146
LI234	Gas stem D Silver									- 146
LI236	Gas stem E Silver									0
LI228	Gas stem 4FL Black									- 224
63100-01	Footring 6F, black, Ø455 mm									916

Accessories/Options/Surcharges:

FB225	Base 5F Silver, Ø590 mm, silver lacquered aluminium	0
FB227	Base 5F Polished, Ø590 mm, polished aluminium	904
FB229	Base 5G Black, Ø630 mm, black lacquered aluminium	189
FB228	Base 5G Silver, Ø630 mm, silver lacquered aluminium	189
FB230	Base 5G Polished, Ø630 mm, polished aluminium	1090
FB210	Base 5N - Ø540 mm, polished steel, for castors 7HN, 7D or 7G increases seat height 25 mm	313
CA205	Castors for soft floors, Ø50 mm, black	0
CA206	Castors for hard floors, Ø50 mm, black	0
CA207	Castors 7G, locks automatically when seated, Ø50 mm	280
CA211	Castors 7D for carpeted floors, Ø50 mm. For base 5N	0
CA212	Castors 7HN for hard floors, Ø50 mm. For base 5N	0

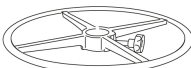
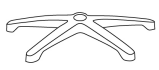
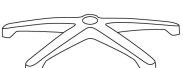
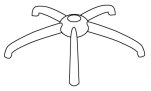
Item no	Description	Accessories/option	Seat height 4501, 4521	Seat height 4511
LI233	Gas stem A Black		415-545 mm	430-560 mm
LI232	Gas stem A Silver		415-545 mm	430-560 mm
LI231	Gas stem B Black		375-510 mm	390-525 mm
LI230	Gas stem B Silver		375-510 mm	390-525 mm
LI235	Gas stem D Black		485-665 mm	500-680 mm
LI234	Gas stem D Silver		485-665 mm	500-680 mm
LI236	Gas stem E Silver		565-810 mm	580-825 mm
LI228	Gas stem 4FL Black		345-430 mm	360-445 mm
63100-01	Footring 6F, black, Ø455 mm			
FB225	Base 5F Silver, Ø590 mm, silver lacquered aluminium			
FB227	Base 5F Polished, Ø590 mm, polished aluminium			
FB229	Base 5G Black, Ø630 mm, black lacquered aluminium			
FB228	Base 5G Silver, Ø630 mm, silver lacquered aluminium			
FB230	Base 5G Polished, Ø630 mm, polished aluminium			
FB210	Base 5N - Ø540 mm, polished steel, for castors 7HN, 7D or 7G. Increases seat height 25 mm			

User Instruction RH Support

Check out our user guide, explaining how each of the unique functions are adjusted. <https://www.youtube.com/watch?v=DJDUiSFiy9s>

RH Secur24

- Seat: width 410 mm, depth 435 mm
- Seat height: 400-520 mm (ON-4S)
- Double-sided operation: seat height, back angle, seat angle adjustment
- Base (5S) in polished aluminium 710 mm and castors for hard floors
- Upholstery: The outside of the RH Secur24 is always finished in black imitation leather in PG3 & PG5. In PG6 & PG7 it is always finished in black natural leather.
- Fabrics to choose from are used for the middle part. See available upholstery option in list below.
- Certified in accordance to: EN-1335, GS, BS5459-2

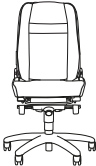









Item no	Base model +	Price Group (PG)	③	⑤	⑥	⑦	Price
3130	RH Secur24 <ul style="list-style-type: none"> • Backrest: width 481 mm, height 829 mm • With 110 mm thick seat cushion & 80 mm thick back cushion • Adjustable lumbar support in depth • Weight: 37,6 kg 		17 812	18 176	20 467	24 641	
3131	RH Secur24 Exclusive <ul style="list-style-type: none"> • Backrest: width 481 mm, height 829 mm • With 110 mm thick seat cushion & 80 mm thick back cushion • Adjustable lumbar support in height & depth • With seat depth adjustment, 120 mm • Weight: 37,6 kg 		19 346	19 703	21 834	26 474	

Accessories/Options/Surcharges:

HR2710	Headrest RH Secur24. Adjustable in height & angle (only for 3130)	2 141
HR2715	Headrest RH Secur24 Exclusive. Adjustable in height, depth & angle	3 507
HC2710	Headrest cover RH Secur24 in Helanca 8628	534
HC2715	Headrest cover RH Secur24 with customer logo in Helanca 8628	Price on request
HC2720	Headrest cover RH Secur24 Exclusive in Helanca 8628	534
HC2725	Headrest cover RH Secur24 Exclusive with customer logo in Helanca 8628	Price on request
002-613-P100	RH Secur24 Hygienical disposal covers for headrest, 100 pieces	194
WR2710	Backrest with weapon recess (Only for: 3130)	2 398
CV2710	Protection cover RH Secur24 for back and seat in Staccato 7020 (only with AR2805, AR2810)	4 476
AE2710	Coat hanger in black laquerad aluminium	2 233
SA2710	Seat slide adjustment (Only for: 3130)	2 195
ME2710	Mechanism with extended tension control for model 3130	1 223
ME2720	Mechanism with extended tension control for model 3130 and 3131 (for seatslide)	

Accessories/Options/Surcharges:

AR2805	Armrest 8SC pair. Adjustable in height & angle	1952
AR2810	Armrest 8SC XL pair. Armrest top in black leather. Adjustable in height & angle	3544
AR2710	Armrest 8F pair. Flipable & adjustable in angle	2932
AR2715	Armrest 8F pair. Armrest top in black leather. Flipable & adjustable in angle	3993
AR2720	Armrest 8H pair. Flipable, adjustable in height & angle	4565
AR2725	Armrest 8H pair. Armrest top in black leather. Flipable & adjustable in angle	5617
LI2730	Gas stem ON-4FZ Black	89
LI2740	Gas stem ON-4FH Polished	176
FB2735	Footbase ON-5S Black, 710 mm	369
125178	Castors for soft floors, Ø65 mm, black	0
CA208	Plastic glide 7K	0

Item no	Description	Accessories/Options	Item no	Description	Accessories/Options
HR2710	Headrest RH Secur24 Adjustable in height & angle Upholstery: Follows selected fabric of the chair (outer & inner)		WR2710	Backrest with weapon recess (Only for 3130)	
HR2715	Headrest RH Secur24 Exclusive Adjustable in height, depth & angle Upholstery: Black Imitation leather, Trento TRO60, Elmo Soft 99999		SA2710	Seat with seatslide (Only for 3130)	
AR2805	Armrest 8SC Black lacquered Adjustable in height & angle		AE2710	Coathanger	
AR2810	Armrest 8SC XL Black lacquered with armrest top XL in black leather. Adjustable in height & angle		FB2735	Base in black lacquered aluminium 710 O mm	
AR2720	Armrest 8H pair. Flipable, adjustable in height & angle		LI2730	Gas stem ON-4FZ Black 440-590 mm	
AR2725	Armrest 8H pair. Armrest top in black leather. Flipable, adjustable in height & angle		LI2740	Gas stem ON-4FH Poliert 490-640 mm	
AR2710	Armrest 8F pair. Flipable & adjustable in angle				
AR2715	Armrest 8F pair. Armrest top in black leather. Flipable & adjustable in angle				

User Instruction RH Secur24

Check out our user guide, explaining how each of the unique functions are adjusted <https://www.youtube.com/watch?v=Orf07DH6SXA>

DELIVERY TIMES FOR RH SECURE24

RH Secur24 Quick-ship: 10 days delivery time

Model	Outer Upholstery	Inner Upholstery
RH Secur24	Black imitation leather	Staccato 7020
RH Secur24 Exclusive	Black imitation leather	Staccato 7020

Additional options for RH Secur24 in Quick-ship:

- Seat-slide
- Seat-slide with weapon recess

RH Secur24 Standard Collection: 23-28 days delivery time

RH Secur24 Extended Collection: 30-35 days delivery time

NOTE! For special requests please contact our Customer Service

UPHOLSTERY GUIDE

HEADREST

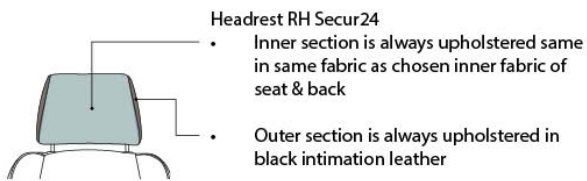

FABRIC CHOICE SEAT & BACK

OUTER & INNER SECTION COMBINATIONS

Outer:
Black imitation leather (standard)
Black leather:
Trento+
Elmosoft

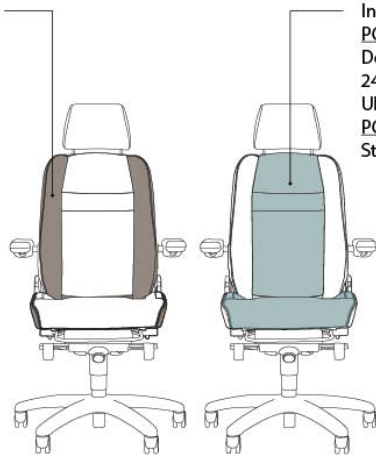

Inner:
PG3
Dolce
24/7+
Ultra
PG5
Staccato

FULLY UPHOLSTERED

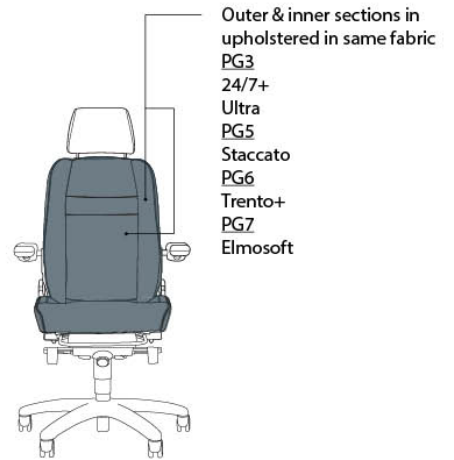

RH Focus

- Backrest: height 684 mm, width 480 mm, thickness 60 mm
- Seat: width 468 mm, depth 475 mm, thickness 60 mm (seat slide 80 mm)
- Seat height: 400-550 mm (ON-4FZ)
- RH Focus F mechanism: double-sided operation: seat height, back angle, seat angle adjustment
- Base (5S) in polished aluminium 710 mm and castors for hard floor
- Certified in accordance to: EN 1335, GS, ANSI/BIFMA X5.1, EPD ISO 14025

Please note: The outer part of the backrest and headrest are always upholstered in black leather. The fabrics to choose from are applicable to the inner part of both backrest and headrest.

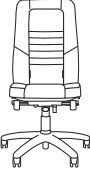







Item no	Base model +	Price Group (PG)	③	⑤	⑦	Price
3135	RH Focus • Weight: 23,9 kg		14 491	14 837	18 477	

Accessories/Options/Surcharges:

HR2720	Headrest RH Focus. Adjustable in height & angle					2 238
HC2730	Headrest cover RH Focus with RH logo					535
002-614-P100	RH Focus Hygienical disposal covers for headrest, 100 pieces					195
HC2735	Headrest cover RH Focus with customer logo					0
HP2710	Holster protect, reinforced upholstery on back (in Black Delinova 200)					1 068
CV2730	Protection cover RH Focus for back and seat in Staccato 7020					4 476
AR2730	Armrest 8K pair. Armrest top in black leather. Adjustable in height & angle					1 868
AR2745	Armrest 8K XL pair. Armrest top in black leather. Adjustable in height & angle					3 455
AR2720	Armrest 8H pair. Flipable, adjustable in height & angle					4 587
AR2725	Armrest 8H pair. Armrest top in black leather. Flipable & adjustable in angle					5 616
AR2710	Armrest 8F pair. Flipable & adjustable in angle					2 715
AR2715	Armrest 8F pair. Armrest top in black leather. Flipable & adjustable in angle					3 993

Accessories/Options/Surcharges:

LI2730	Gas stem ON-4FZ Black	89
LI2740	Gas stem ON-4FH Polished	176
FB2735	Footbase ON-5S Black, 710 mm	369
125178	Castors for soft floors, Ø65 mm, black	0
CA208	Plastic glide 7K	0

Item no	Description	Accessories/Options	Item no	Description	Accessories/Options
HR2720	Headrest RH Focus. Adjustable in height & angle Upholstery: Outer part in black leather		HP2710	Holster protect, reinforced upholstery on back	
AR2730	Armrest 8K Black lacquered Adjustable in height & angle		LI2730	Gas stem ON-4FZ Black 420-555 mm	
AR2745	Armrest 8K XL Black lacquered with armrest top XL in black leather. Adjustable in height & angle		LI2740	Gas stem ON-4FH Polished 450-600 mm	
AR2720	Armrest 8H pair. Flipable, adjustable in height & angle		FB2735	Base in black lacquered aluminium 710 Ø mm	
AR2725	Armrest 8H pair. Armrest top in black leather. Flipable, adjustable in height & angle				
AR2710	Armrest 8F pair. Flipable & adjustable in angle				
AR2715	Armrest 8F pair. Armrest top in black leather. Flipable & adjustable in angle				

User Instruction RH Focus

Check out our user guide, explaining how each of the unique functions are adjusted <https://www.youtube.com/watch?v=8TyXdip7kpw>

RH Logic 400/300 ESD - Udgår af prislisen i løbet af 2024



- Seat: width 457 mm, depth 465 mm (seatslide 80 mm)
- Seat height: 440-560 mm (4F Logic)
- Base in black aluminium (5X black) and free wheeling ESD castors 7FM (metal)
- Upholstered backshell
- Upholstered in Global ESD Melange (1508-291) or black antistatic vinyl
- Certified in accordance to: EN 1335, BS5459, Möbelfakta, EPD ISO 14025, Nordic Swan, GREENGUARD GOLD, IEC 61340 (ESD)

Item no	Base model +	Price Group (PG)	Price
3346	RH Logic 300 ESD • Backrest: width 447 mm, height 510 mm • Weight: 21 kg		15051

3556	RH Logic 400 ESD • Backrest: with lumbar pump: width 447 mm, height 620 mm • Weight: 21,8 kg		17554
------	--	---	-------

Accessories/Options/Surcharges:

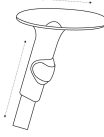
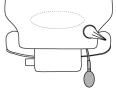
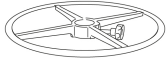
8700420	Armrest 8E ESD pair (black). Adjustable in height, depth & width	2167
LP201	Lumbar pump (Only for: 3346)	628
LI217	Gas stem B (Chrome)	0
FB215	Base 5X Polished, Ø660 mm, polished aluminium	720
CA219	Castors, antistatic, for hard floors	- 288
63100-01	Footring 6F, black, Ø455 mm	916

Item no	Description	Accessories/option	Item no	Description	Accessories/option
8700420	Armrest 8E ESD pair (black). Adjustable in height, depth & width. Height of armrest above seat 198-299 mm		LP201	Lumbar pump (only for: 3346)	
63100-01	Footring 6F, black, Ø455 mm		FB215	Base 5X Polished, Ø660 mm, polished aluminium	
LI217	Gas stem B (Chrome) Seat height 480-610 mm				

User Instruction RH Logic 400/300

Check out our user guide, explaining how each of the unique functions are adjusted. <https://www.youtube.com/watch?v=vM7s6RymQFs>

RH Extend ESD - Udgår af prislisen i løbet af 2024



- Seat: width 461 mm, depth 465 mm (seatslide 80 mm)
- Seat height: 440-560 mm (4F Logic)
- Base in black aluminium (5X black) and free wheeling ESD castors 7FM (metal)
- Upholstered backshell
- Upholstered in Global ESD Melange (1508-291) or black antistatic vinyl
- Certified in accordance to: EN 1335, GS, BS 5459/2, Möbelfakta, EPD ISO 14025, GREENGUARD GOLD, IEC 61340 (ESD)

Item no	Base model +	Price Group (PG)	Price
6116	RH Extend 200 ESD • Backrest medium: width 440 mm, height 510 mm • Weight: 19 kg		12339

6216	RH Extend 220 ESD • Backrest large: width 440 mm, height 620 mm • Weight: 19,8 kg		13274
------	---	---	-------

Accessories/Options/Surcharges:

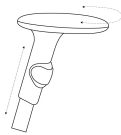
8700420	Armrest 8E ESD pair (black). Adjustable in height, depth & width	2167
FB215	Base 5X Polished, Ø660 mm, polished aluminium	720
CA219	Castors, antistatic, for hard floors	- 288



Item no	Description	Accessories/option	Item no	Description	Accessories/option
8700420	Armrest 8E ESD pair (black). Adjustable in height, depth & width. Height of armrest above seat 220-297 mm		FB215	Base 5X Polished, Ø660 mm, polished aluminium	

User Instruction RH Extend

Check out our user guide, explaining how each of the unique functions are adjusted. <https://www.youtube.com/watch?v=0F0aJG1JbdI>

RH Activ ESD

- Seat height: 392-522 mm (B Chrome)
- Base in black lacquered aluminium (5F) and free wheeling ESD castors 7FM (metal)
- Upholstered in Global ESD Melange (1508-291) or black antistatic vinyl
- Certified in accordance to: EN 1335, BS5459, Möbelfakta, EPD ISO 14025, GREENGUARD GOLD, IEC 61340 (ESD)

Item no	Base model +	Price Group (PG)	Price
2776	RH Activ 200 ESD <ul style="list-style-type: none"> • Backrest medium ESD: width 370 mm, height 295 mm • Seat medium: width 440 mm, depth 430 mm (seatslide 55 mm) • Weight: 13 kg 		8 039
2876	RH Activ 220 ESD <ul style="list-style-type: none"> • Backrest large ESD: width 370 mm, height 430 mm • Seat medium: width 440 mm, depth 430 mm (seatslide 55 mm) • Weight: 13,6 kg 		8 504
2886	RH Activ 222 ESD <ul style="list-style-type: none"> • Backrest large ESD: width 370 mm, height 430 mm • Seat large: width 460 mm, depth 460 mm (seatslide 55 mm) • Weight: 13,6 kg 		8 855



Accessories/Options/Surcharges:

8700420	Armrest 8E ESD pair (black). Adjustable in height, depth & width	2 167
LI2742	Gas stem ON-4FH Black	0
LI219	Gas stem D (Chrome)	81
LI220	Gas stem E (Chrome)	224
LI206	Gas stem 4FL (Chrome)	0
63100-01	Footring 6F, black, Ø455 mm	916
FB227	Base 5F Polished, Ø590 mm, polished aluminium	904
FB229	Base 5G Black, Ø630 mm, black lacquered aluminium	189
FB230	Base 5G Polished, Ø630 mm, polished aluminium	1 090
CA219	Castors, antistatic, for hard floors	- 288
CA209	Castor 7HF	- 288
FB207	Footbase 5J	718
FB206	Footbase 5MP	720

VALID COMBINATIONS

Model: 2776	
Base: 5F	Gas stem: 4FL, B, ON-4FH, D, E
Base: 5G	Gas stem: 4FL, B, ON-4FH, D, E

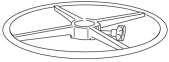
Model: 2876 & 2686	
Base 5F:	Gas stem: 4FL, B
Base 5G	Gas stem: 4FL, B, ON-4FH, D, E

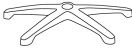
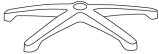

Item no	Description	Accessories/option	Item no	Description	Accessories/option
8700420	Armrest 8E ESD pair (black). Adjustable in height, depth & width. Height of armrest above seat 190-290 mm		63100-01	Footring 6F, black, Ø455 mm	
LI2742	Gas stem ON-4FH Black Seat height 459-607 mm		FB227	Base 5F Polished, Ø590 mm, polished aluminium	
LI219	Gas stem D (Chrome) Seat height 515-690 mm		FB229	Base 5G Black, Ø630 mm, black lacquered aluminium	
LI220	Gas stem E (Chrome) Seat height 605-855 mm		FB230	Base 5G Polished, Ø630 mm, polished aluminium	
LI206	Gas stem 4FL (Chrome) Seat height 375-465 mm				

User Instruction RH Activ

Check out our user guide, explaining how each of the unique functions are adjusted. <https://www.youtube.com/watch?v=hexc6goUiM4>

RH Activ ESD Cleanroom

- Work chair for cleanroom environment designed to deflect static electricity, release a minimum of particles and easy to clean
- Seat medium Cleanroom: width 440 mm, depth 430 mm (seatslide 55 mm)
- Seat height: 392-522 mm (B Chrome)
- Base in black lacquered aluminium (5F) and free wheeling ESD castors 7FM (metal)
- Upholstered in black antistatic vinyl
- Approved according to ISO Class 4.
- Certified in accordance to: EN 1335, BS5459, Möbelfakta, EPD ISO 14025, GREENGUARD GOLD, IEC 61340 (ESD)





Item no	Base model +	Price Group (PG)	Price
2774	RH Activ 200 ESD Cleanroom <ul style="list-style-type: none"> • Backrest medium ESD Cleanroom: width 370 mm, height 295 mm • Weight: 13 kg 		9 505
2874	RH Activ 220 ESD Cleanroom <ul style="list-style-type: none"> • Backrest large ESD Cleanroom: width 370 mm, height 430 mm • Weight: 13,6 kg 		9 973

Accessories/Options/Surcharges:

8700420	Armrest 8E ESD pair (black). Adjustable in height, depth & width	2 167
LI2742	Gas stem ON-4FH Black	0
LI219	Gas stem D (Chrome)	81
LI220	Gas stem E (Chrome)	224
LI206	Gas stem 4FL (Chrome)	0
63100-01	Footring 6F, black, Ø455 mm	916
FB227	Base 5F Polished, Ø590 mm, polished aluminium	904
FB229	Base 5G Black, Ø630 mm, black lacquered aluminium	189
FB230	Base 5G Polished, Ø630 mm, polished aluminium	1 090
CA219	Castors, antistatic, for hard floors	- 288

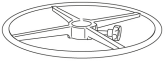
VALID COMBINATIONS

Model: 2774	
Base: 5F	Gas stem: 4FL, B, ON-4FH, D, E
Base: 5G	Gas stem: 4FL, B, ON-4FH, D, E
Model: 2874	
Base: 5F	Gas stem: 4FL, B
Base: 5G	Gas stem: 4FL, B, ON-4FH, D, E



Item no	Description	Accessories/option	Item no	Description	Accessories/option
8700420	Armrest 8E ESD pair (black). Adjustable in height, width & rotatable. Height of armrest above seat 190-290 mm		63100-01	Footring 6F, black, Ø455 mm	
LI2742	Gas stem ON-4FH Black Seat height 459-607 mm		FB227	Base 5F Polished, Ø590 mm, polished aluminium	
LI219	Gas stem D (Chrome) Seat height 515-690 mm		FB229	Base 5G Black, Ø630 mm, black lacquered aluminium	
LI220	Gas stem E (Chrome) Seat height 605-855 mm		FB230	Base 5G Polished, Ø630 mm, polished aluminium	
LI206	Gas stem 4FL (Chrome) Seat height 375-465 mm				

User Instruction RH Activ

Check out our user guide, explaining how each of the unique functions are adjusted. <https://www.youtube.com/watch?v=hexc6goUiM4>

RH Activ Cleanroom

- Work chair for cleanroom environment, designed to release a minimum of particles and easy to clean
- Seat medium Cleanroom: width 440 mm, depth 430 mm (seatslide 55 mm)
- Seat height: 392-522 mm (B Black)
- Base in black lacquered aluminium (5F) and castors for hard floors
- Upholstered in black antistatic vinyl
- Approved according to ISO Class 4 and ISO Class 5.
- Certified in accordance to: EN 1335, BS5459, Möbelfakta, EPD ISO 14025, GREENGUARD GOLD, ISO Class 4

Item no	Base model +	Price Group (PG)	Price
2773	RH Activ 200 Cleanroom <ul style="list-style-type: none"> • Backrest medium Cleanroom: width 370 mm, height 295 mm • Weight: 13 kg 		7 720
2873	RH Activ 220 Cleanroom <ul style="list-style-type: none"> • Backrest large Cleanroom: width 370 mm, height 430 mm • Weight: 13,6 kg 		8 125
Accessories/Options/Surcharges:			
8300130-02	Armrest 8S pair (black). Adjustable in height, width & rotatable		1 623
8700130-02	Armrest 8E pair (black). Adjustable in height, depth & width		1 694
8700280-02	Armrest 8E pair (black). Upholstered armrest top black leather. Adjustable in height, depth & width		2 489
LI233	Gas stem A Black		0
LI232	Gas stem A Silver		0
LI230	Gas stem B Silver		0
LI235	Gas stem D Black		81
LI237	Gas stem E Black		224
LI236	Gas stem E Silver		224
LI228	Gas stem 4FL Black		0
63100-01	Footring 6F, black, Ø455 mm		916
FB225	Base 5F Silver, Ø590 mm, silver lacquered aluminium		0
FB227	Base 5F Polished, Ø590 mm, polished aluminium		904
FB229	Base 5G Black, Ø630 mm, black lacquered aluminium		189
FB228	Base 5G Silver, Ø630 mm, silver lacquered aluminium		189
FB230	Base 5G Polished, Ø630 mm, polished aluminium		1 090
FB210	Base 5N - Ø540 mm, polished steel, for castors 7HN, 7D or 7G increases seat height 25 mm		313
125104	Castors for soft floors, Ø50 mm, black		95
7110050	Castors 7D for carpeted floors, Ø50 mm. For base 5N		115
71400	Castor 7G, locks automatically when seated, Ø50 mm		191
7110060	Castors 7HN for hard floors, Ø50 mm. For base 5N (only for 2772, 2782)		144

Accessories/Options/Surcharges:







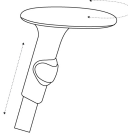

71810

Plastic glide 7K

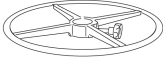
122

VALID COMBINATIONS

Model: 2773	
Base: 5N	Gas stem: 4FL, B
Base: 5F	Gas stem: 4FL, B, A, D, E
Base: 5G	Gas stem: 4FL, B, A, D, E
Model: 2873	
Base: 5F	Gas stem: 4FL, B
Base: 5G	Gas stem: 4FL, B, A, D, E

Item no	Description	Accessories/option	Item no	Description	Accessories/option
8300130-02	Armrest 8S pair (black). Adjustable in height, width & rotatable. Height of armrest above seat 190-290 mm		8700130-02	Armrest 8E pair (black). Adjustable in height, depth & width. Height of armrest above seat 190-290 mm	
63100-01	Footring 6F, black, Ø455 mm		8700280-02	Armrest 8E pair (black). Upholstered armrest top black leather. Adjustable in height, depth & width. Height of armrest above seat 190-290 mm	
LI233	Gas stem A Black Seat height 437-573 mm		FB225	Base 5F Silver, Ø590 mm, silver lacquered aluminium	
LI232	Gas stem A Silver Seat height 437-573 mm		FB227	Base 5F Polished, Ø590 mm, polished aluminium	
LI230	Gas stem B Silver Seat height 392-522 mm		FB229	Base 5G Black, Ø630 mm, black lacquered aluminium	
LI235	Gas stem D Black Seat height 500-680 mm		FB228	Base 5G Silver, Ø630 mm, silver lacquered aluminium	
LI237	Gas stem E Black Seat height 605-855 mm		FB230	Base 5G Polished, Ø630 mm, polished aluminium	
LI236	Gas stem E Silver Seat height 605-855 mm		FB210	Base 5N - Ø540 mm, polished steel	
LI228	Gas stem 4FL Black Seat height 370-460 mm		71810	Plastic glide 7K	

User Instruction RH Activ

Check out our user guide, explaining how each of the unique functions are adjusted. <https://www.youtube.com/watch?v=hexc6goUiM4>

Spare parts

Spareparts RH Axia Exclusive (seat and back pads), RH Secur24 & RH Focus. Please contact our Customer Service for information

Item no	Neckrest	Price
740500-1	Neckrest RH Logic 200 Silver in fabric. Adjustable in height & depth	1369
740550-1	Neckrest RH Logic 200 Silver in leather. Adjustable in height & depth	1742
740500-2	Neckrest RH Logic 200 Black in fabric. Adjustable in height & depth	1369
740550-2	Neckrest RH Logic 200 Black in leather. Adjustable in height & depth	1742
740504	Neckrest pad RH Logic 200 in fabric	1045
740554	Neckrest pad RH Logic 200 in leather	1275
15022	Neckrest RH Logic 400 in fabric/C.O.M. Adjustable in height & depth	964
15032	Neckrest RH Logic 400 in leather. Adjustable in height & depth	1447
100091	Neckrest cover RH Logic 400	117
730006-1	Neckrest RH Mereo in fabric/C.O.M Silver (only for 8211, 8311). Adjustable in height, depth and angle	1173
730006-2	Neckrest RH Mereo in fabric/C.O.M Black (only for 8312, 8212). Adjustable in height, depth and angle	1173
730006-3	Neckrest RH Mereo Silver Grey in fabric/C.O.M (only for 8213, 8313). Adjustable in height, depth and angle	1187
730016-1	Neckrest RH Mereo in leather Silver (only for 8211, 8311). Adjustable in height, depth and angle	1440
730016-2	Neckrest RH Mereo in leather Black (only for 8312, 8212). Adjustable in height, depth and angle	1440
730016-3	Neckrest RH Mereo Silver Grey in leather(only for 8213, 8313). Adjustable in height, depth and angle	1453
100023	Neckrest RH Extend. Upholstered in Xtreme 009. Adjustable in height & depth	1525
100023-01	Neckrest RH Extend in fabric/C.O.M. Adjustable in height & depth	1895
100023-02	Neckrest RH Extend in leather. Adjustable in height & depth	2036
100026	Neckrest pad RH Extend	950
15041	Neckrest Cassette for RH Logic 300 &Extend 100/200	85

Item no	Backrest pads	①	②	③	④	⑤	⑥	⑦
740206	Backrest pad RH Logic 200. From 2019	2444	2464	2489	2577	2731		3514
740273	Backrest pad RH Logic Elite 200. From 2022	2809	2834	2863	2963	3141		4041
740203	Backrest pad RH Logic 220. From 2019	3054	3081	3112	3221	3412		4393
740271	Backrest pad RH Logic Elite 220. From 2022	3513	3543	3579	3703	3924		5052
740204	Backrest RH Logic 200 (complete) From 2019	3615	3647	3684	3814	4041		5200
740272	Backrest RH Logic Elite 200 (complete). From 2022	4157	4195	4237	4385	4647		5980
740200	Backrest RH Logic 220 (complete) From 2019	4212	4251	4293	4444	4710		6062
740270	Backrest RH Logic Elite 220 (complete). From 2022	4844	4889	4936	5109	5415		6971
10031	Back pad RH Logic 300. From 2006	1355	1416	1492	1759	2074	3243	3795
10044	Backrest pad RH Logic 300 Elite. From 2016	2097	2155	2234	2499	2814	3986	4662
10032	Backrest pad RH Logic 300 Comfort. From 2006	2097	2155	2234	2499	2814	3986	4662
10001	Backrest pad RH Logic 400. From 2005	2980	3081	3188	3528	3951	5298	6199
10021	Backrest pad RH Logic 400 Comfort. From 2005	3944	4041	4152	4490	4911	6257	7320
10023	Backrest pad RH Logic 400 Elite. From 2016	3944	4041	4152	4490	4911	6257	7320

Item no	Backrest pads	①	②	③	④	⑤	⑥	⑦
730003	Backrest RH Mereo 200 black plastic (complete) From 2013	1 433	1 446	1 462	1 513	1 604	1 762	2 060
730002	Backrest RH Mereo 220 black plastic (complete) From 2013	1 586	1 603	1 619	1 672	1 771	1 952	2 284
730004-2	Backrest RH Mereo 300 black plastic (complete) From 2019	2 259	2 280	2 305	2 384	2 527	2 779	3 252
730003-3	Backrest RH Mereo 200 grey plastic (complete) From 2019	1 869	1 887	1 906	1 972	2 091	2 299	2 690
730002-3	Backrest RH Mereo 220 grey plastic (complete) From 2019	2 110	2 128	2 150	2 225	2 359	2 595	3 035
730004-3	Backrest RH Mereo 300 grey plastic (complete) From 2019	2 156	2 176	2 199	2 276	2 411	2 654	3 104
100036	Backrest pad RH Activ Medium. From 2011	853	897	940	1 039	1 154	1 729	2 022
100034	Backrest pad RH Activ Large. From 2011	1 369	1 415	1 456	1 555	1 669	2 247	2 628
1850026	Backrest pad RH Extend Medium. From 2008	1 141	1 192	1 233	1 436	1 772	2 510	2 937
1860026	Backrest pad RH Extend Large. From 2008	1 631	1 684	1 727	1 933	2 273	3 548	4 150
111002	Backrest pad RH17	715	757	794	884	992	1 541	1 803

- For options on pads, see each chair model.
- Complete = Pad + Shell

Item no	Upholst. backshell RH Logic	①	②	③	④	⑤	⑦
740207	Upholstered backshell RH Logic 200. From 2019	2 512	2 533	2 560	2 649	2 809	3 615
740202	Upholstered backshell RH Logic 220. From 2019	2 512	2 533	2 560	2 649	2 809	3 615

Item no	Seat pads	①	②	③	④	⑤	⑥	⑦	Price
740101	Seat pad RH Logic 200. From 2019	2 191	2 211	2 231	2 309	2 449		3 152	
740103	Seat pad XL RH Logic 200. From 2019	3 565	3 597	3 633	3 760	3 986		5 130	
740125	Seatpad RH Logic Elite 200. From 2022	2 519	2 543	2 567	2 655	2 815		3 625	
740127	Seatpad RH Logic Elite 200 XL. From 2022	4 101	4 136	4 178	4 324	4 583		5 899	
20002	Seat pad RH Logic 400. From 2008	2 025	2 110	2 206	2 484	2 822	4 013	4 695	
20022	Seat pad RH Logic 400 Comfort. From 2008	2 569	2 653	2 749	3 028	3 369	4 562	5 338	
20023	Seat pad RH Logic 400 Elite. From 2016	2 569	2 653	2 749	3 028	3 369	4 562	5 338	
20037	Seat pad RH Logic 400 XL. From 2008	3 535	3 620	3 716	3 993	4 333	5 524	6 464	
20038	Seat pad RH Logic 400 XL Comfort. From 2008	4 083	4 163	4 260	4 538	4 877	6 071	7 103	
20039	Seat pad RH Logic 400 XL Elite. From 2016	4 083	4 163	4 260	4 538	4 877	6 071	7 103	
730110	Seat pad RH Mereo. From 2013	1 531	1 544	1 561	1 617	1 711	1 883	2 204	
730114	Seat pad RH Mereo XL	2 269	2 288	2 313	2 395	2 535	2 791	3 266	
2850025	Seat pad RH Extend. From 2008	1 892	1 944	1 980	2 182	2 522	3 267	3 822	
2860025	Seat pad RH Extend XL. From 2012	3 288	3 341	3 380	3 580	3 922	4 661	5 453	
200018	Seat RH Activ Medium (complete) From 2011	1 415	1 459	1 498	1 600	1 712	2 292	2 682	
200019	Seat RH Activ Large (complete) From 2011	1 881	1 926	1 967	2 068	2 181	2 760	3 230	
200020	Seat RH Activ Medium Cashier (complete) From 2011	2 180	2 224	2 265	2 363	2 481	3 058	3 577	
25500	Seat RH7 Limpan (complete)	1 143	1 186	1 220	1 313	1 421	1 971	2 306	
26000	Seat RH8 Sadel (complete)	1 368	1 413	1 445	1 536	1 652	2 195	2 568	
26500	Lumbar pump	1 181	1 223	1 257	1 351	1 461	2 008	2 350	
750238	Seat RH Mereo 200/220 XL from 2022	0	0	0	0	0	0		1 030

Item no	Seat pads	①	②	③	④	⑤	⑥	⑦	Price
---------	-----------	---	---	---	---	---	---	---	-------

- For options on pads, see each chair model.
- Complete = Pad + Shell

Item no	Gas stem	Price
143201-1A	Gas stem A Black	1041
143201-2A	Gas stem A Silver	1041
143201-7024	Gas stem A Grey (RAL 7024)	1071
143206-3A	Gas stem B Black	784
143206-2A	Gas stem B Silver	784
520020-03	Gas stem B (chrome)	1341
143202-3A	Gas stem D Black	1041
143202-2A	Gas stem D Silver	1041
143204-3A	Gas stem E Black	1216
143204-2A	Gas stem E Silver	1216
42000-1	Gas stem 4FL Black	1341
520011-05	Gas stem 4P Black	1573
520011	Gas stem 4P Silver	1573
520001-05	Gas stem 4Q Black	1573
520001	Gas stem 4Q Silver	1573
730403-2	Gas stem 4T Black	1573
730403-1	Gas stem 4T Silver	1573
730404-2	Gas stem 4T NPR Black	1573
730404-1	Gas stem 4T NPR Silver	1573

- For seat heights, see section Physical measurements.

Item no	Armrests	Price
740400-1	Armrest 8L Silver pair. Armrest top in TPU (black). Adjustable in height, depth, width & turnable	1868
740480-1	Armrest 8L Silver right. Armrest top in TPU (black). Adjustable in height, depth, width & turnable	934
740482-1	Armrest 8L Silver left. Armrest top in TPU (black). Adjustable in height, depth, width & turnable	934
740401-1	Armrest 8L Silver pair. Armrest top in black leather (black). Adjustable in height, depth, width & turnable.	2487
740484-1	Armrest 8L Silver right. Armrest top in black leather (black). Adjustable in height, depth, width & turnable	1244
740486-1	Armrest 8L Silver left. Armrest top in black leather (black). Adjustable in height, depth, width & turnable	1244
740406-1	Armrest 8L XL Silver pair. Armrest top in leather (black). Adjustable in height, depth, width & turnable	2884
740481-1	Armrest 8L XL Silver right. Armrest top in leather (black). Adjustable in height, depth, width & turnable	1442
740483-1	Armrest 8L XL Silver left. Armrest top in leather (black). Adjustable in height, depth, width & turnable	1442
740400-2	Armrest 8L pair. Armrest top in TPU (black). Adjustable in height, depth, width & turnable. From 2019	1868
740480-2	Armrest 8L right. Armrest top in TPU (black). Adjustable in height, depth, width & turnable. From 2019	934
740482-2	Armrest 8L left. Armrest top in TPU (black). Adjustable in height, depth, width & turnable. From 2019	934
740401-2	Armrest 8L Black pair. Armrest top in black leather (black). Adjustable in height, depth, width & turnable. From 2019	2487
740484-2	Armrest 8L right. Armrest top in black leather (black). Adjustable in height, depth, width & turnable. From 2019	1244

Item no	Armrests	Price
740486-2	Armrest 8L left. Armrest top in black leather (black). Adjustable in height, depth, width & turnable. From 2019	1 244
740406-2	Armrest 8L XL Black pair. Armrest top in leather (black). Adjustable in height, depth, width & turnable	2 884
740481-2	Armrest 8L XL Black right. Armrest top in leather (black). Adjustable in height, depth, width & turnable	1 442
740483-2	Armrest 8L XL Black left. Armrest top in leather (black). Adjustable in height, depth, width & turnable	1 442
740462-2	Armrest traverse Black. To supplement with armrest at a later stage. From 2019	551
8300130-02	Armrest 8S pair (black). Adjustable in height, width & rotatable	1 623
8300135-02	Armrest 8S right (black). Adjustable in height and width. Rotating.	810
8300136-02	Armrest 8S left (black). Adjustable in height, width & rotatable	810
8300230-02	Armrest 8S XL pair (black). Upholstered armrest top in black leather. Adjustable in height, width & rotatable	2 613
8300235-02	Armrest 8S XL right (black). Upholstered armrest top in black leather. Adjustable in height, width & rotatable	1 308
8300236-02	Armrest 8S XL left (black). Upholstered armrest top in black leather. Adjustable in height, width & rotatable	1 308
8700130-02	Armrest 8E pair (black). Adjustable in height, depth & width	1 694
8700135-02	Armrest 8E right (black). Adjustable in height, depth & width.	847
8700136-02	Armrest 8E left (black). Adjustable in height, depth & width.	847
8700280-02	Armrest 8E pair (black). Upholstered armrest top black leather. Adjustable in height, depth & width	2 489
8700285-02	Armrest 8E right (black). Upholstered armrest top black leather. Adjustable in height, depth & width.	1 246
8700286-02	Armrest 8E left (black). Upholstered armrest top black leather. Adjustable in height, depth & width.	1 246
8700420	Armrest 8E ESD pair (black). Adjustable in height, depth & width	2 167
8700425	Armrest 8E ESD right (black). Adjustable in height, depth & width.	1 084
8700426	Armrest 8E ESD left (black). Adjustable in height, depth & width.	1 084
730019-1	Armrest 8T pair Silver. Adjustable in height, depth, width & turnable.	1 566
730011-1	Armrest 8T right Silver. Adjustable in height, depth, width & turnable. From 2019	781
730009-1	Armrest 8T left Silver Adjustable in height, depth, width & turnable. From 2019	782
730031-1	Armrest 8T XL Silver pair. Adjustable in height, depth, width & turnable	2 411
730032-1	Armrest 8T XL Silver right. Adjustable in height, depth, width & turnable	1 206
730033-1	Armrest 8T XL Silver left. Adjustable in height, depth, width & turnable	1 206
730030-1	Armrest traverse Silver. To supplement with armrests at a later stage	568
730019-2	Armrest 8T Black pair. Adjustable in height, depth, width & turnable	1 566
730011-2	Armrest 8T right Black. Adjustable in height, depth, width & turnable. From 2019	782
730009-2	Armrest 8T left Black. Adjustable in height, depth, width & turnable. From 2019	782
730031-2	Armrest 8T XL Black pair. Adjustable in height, depth, width & turnable	2 411
730032-2	Armrest 8T XL Black right . Adjustable in height, depth, width & turnable	1 206
730033-2	Armrest 8T XL Black left. Adjustable in height, depth, width & turnable	1 206
730030-2	Armrest traverse Black. To supplement with armrests at a later stage	568
730019-3	Armrest 8T Silver Grey pair. Adjustable in height, depth, width & turnable	1 613
730011-3	Armrest 8T right Silver Grey. Adjustable in height, depth, width & turnable. From 2019	806
730009-3	Armrest 8T left Silver Grey. Adjustable in height, depth, width & turnable. From 2019	806
730031-3	Armrest 8T XL Silver Grey pair. Adjustable in height, depth, width & turnable	2 483
730032-3	Armrest 8T XL Silver Grey right. Adjustable in height, depth, width & turnable	1 103

Item no	Armrests	Price
730033-3	Armrest 8T XL Silver Grey left. Adjustable in height, depth, width & turnable	1 103
730030-3	Armrest traverse Silver Grey. To supplement with armrests at a later stage	571
ON-8N-ZW	Armrest 8N Multi pair (black)	1 203
ON-8N-ZW-X	Armrest 8N Multi XL pair (black) Upholstered armrest top in black leather.	2 372
ON-8N-AP	Armrest 8N Multi pair (polished)	1 203
ON-8K-ZW	ON-8K-ZW 24/7 multi-armrests black coated (standard)	1 868
ON-8K-ZW-X	ON-8K-ZW-X 24/7 XL-armrests black coated with black leather top	3 455
ON-8SC-ZW	Multi-armrests black coated (ON-8SC-ZW)	1 952
ON-8SC-ZW-X	XL-armrests, black coated with black leather top	3 544

NOTE! Chairs delivered after October 2018 have new armrest locking screw. Please check delivery date of your chair before ordering.

Item no	Footbase	Price
510016-02	Base 5F Black, Ø590 mm, black lacquered aluminium	1 000
510016-01	Base 5F Silver, Ø590 mm, silver lacquered aluminium	1 000
510016-03	Base 5F Polished, Ø590 mm, polished aluminium	1 931
510015-02	Base 5G Black, Ø630 mm, black lacquered aluminium	1 048
510015-01	Base 5G Silver, Ø630 mm, silver lacquered aluminium	1 048
510015-03	Base 5G Polished, Ø630 mm, polished aluminium	2 025
56400	Base 5N - Ø540 mm, polished steel, for castors 7HN, 7D or 7G increases seat height 25 mm	1 229
740118-2	Base 5T Black, Ø680 mm, black lacquered aluminium	820
740118-1	Base 5T Silver, Ø680 mm, silver lacquered aluminium	820
FB221	Base 5T Polished, Ø680 mm, polished aluminium	1 390
510013-02	Base 5X Black, Ø660 mm, black lacquered aluminium	1 220
510013-01	Base 5X Silver, Ø660 mm, silver lacquered aluminium	1 220
510013-03	Base 5X Polished, Ø660 mm, polished aluminium	2 200

Item no	Castors	Price
125108	Castors for hard floors, Ø50 mm, black	95
125104	Castors for soft floors, Ø50 mm, black	95
7110050	Castors 7D for carpeted floors, Ø50 mm. For base 5N	115
72400	Castor Ø50 mm 7FM free wheeling ESD castors (metal)	237
71400	Castor 7G, locks automatically when seated, Ø50 mm	191
7110060	Castors 7HN for hard floors, Ø50 mm. For base 5N (only for 2772, 2782)	144
125115	Castors, Antistatic, for hard floors	122
125178	Castors for soft floors, Ø65 mm, black	101
125177	Castors Ø65 mm, for hard and soft floors, black	101
125177-D	Castors Ø65 mm, for hard and soft floors, grey	95
105000348020	Castors manually lockable, Ø65 mm	107
71810	Plastic glide 7K	122

Item no	Castors	Price
ON-7UK	Plastic glide ON-7UK	63

Item no	Miscellaneous	Price
150012-06	Lumbar pump bulb for RH Logic 300 & 400	270
9990000	Gas stem remover	773

Item no	Ungrouped	Price
63100-01	Footring 6F, black, Ø455 mm	916

Standard Fabric & Colour Collection

10 year guarantee as standard or 5 year guarantee on 24/7 use.

The Standard Fabric & Colour Collection is our collection of fabrics, leathers and other materials.

The collection has been designed to bring out the best visual and functional qualities of these materials. All fabrics and leathers in our Standard collection are of excellent quality. We offer short delivery times, a wide range and all our materials comply with strict environmental requirements.

Maintenance: To maintain fabrics and leather, please vacuum with a furniture brush or use a clean cloth or sponge slightly dampened with clean lukewarm water. Delivery time from factory is approx 20 working days from receipt of order confirmation.

NOTE! Some fabrics in our Collections may not be approved for all RH chairs, please contact our Customer Service for more information.

CURA (GABRIEL) - PRICE GROUP 1

Cura is a two-coloured fabric made from 98% post-consumer recycled polyester. It has a matt, slightly irregular and natural-looking texture where the dark, underlying grey fibers create a discreet yet vibrant melange effect. High durability and stretchability and its soft, voluminous touch make Cura suitable for both office and lounge furniture.

Composition: 98% post-consumer recycled polyester, 2% polyester

Weight: 420 g/lm

Abrasion resistance: 100 000 Martindale (EN ISO 12947-2)

Flammability: BS EN 1021: 1-2, BS 5852 0&1, CA TB 117-2013, ASTM E 84 Class I

Light fastness: 5-8 (EN ISO 105 - B02)

Rubbing fastness: 4-5/4-5 (Wet/Dry) (EN ISO 105X12)

Pilling: 4-5 (EN ISO 12945-2)

Environmental facts: EU Ecolabel, Oeko-Tex® Standard 100, Contains no Flame Retardant chemicals, ISO 14001 certified company

Design: Cenk Kivrikoglu

Produced in: Lithuania

Cleaning: Wash or dry cleaning, Can be disinfected with ethanol and is bleach-cleanable (For further info follow Gabriel´s cleaning guidelines – www.gabriel.dk)

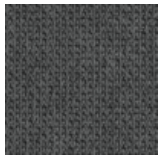

CU60109

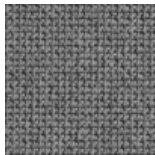

CU60110

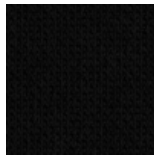

CU60999

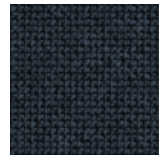

CU66165

XTREME (CAMIRA) - PRICE GROUP 1

Xtreme is a crepe fabric made from 100% post-consumer recycled polyester that features exceptional Euro flammability performance. Extra stretch and structure gives an irregular, shiny finish.

Composition: 100% post-consumer recycled polyester

Weight: 310 g/m²

Abrasion resistance: >100 000 Martindale (EN ISO 12947-2)

Flammability: BS EN 1021: 1-2 (Cigarette & match), BS 7176 Low & Medium Hazard, BS 5852 Section 4 Crib 5, DIN 4102 B1, UNI 9175 Class 1 IM, NF D 60-013

Light fastness: 6 (EN ISO 105 - B02: 2013)

Rubbing fastness: 4/4 (Wet/Dry) (EN ISO 105X12)

Pilling: 5 (EN ISO 12945-2)

Environmental facts: EU Ecolabel, Oeko-Tex® Standard 100, Indoor Advantage™ "Gold", non metallic dyestuffs, ISO 14001 certified company.

Design: Camira Design Studio

Produced in: United Kingdom

Cleaning & disinfection: Washable to 60 °C and bleach cleanable (For further info follow Camira's cleaning guidelines – www.camirafabrics.com)

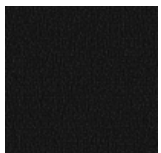

EXR009

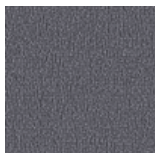

EXR081

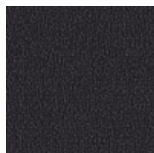

EXR145

SELECT (GABRIEL) - PRICE GROUP 2

Select is a classic woolen fabric with a tightly woven relief structure, combining excellent softness, stretch and durability. Its rich texture with the interplay of light and shadow add depth in all the colours in the palette.

Composition: 85% New Zealand wool, 15% polyamide

Abrasion resistance: 200 000 Martindale (EN ISO 12947-2)

Flammability: BS EN 1021: 1-2, BS 5852 0&1, BS5852 Crib 5, CA TB 117-2013, IMO MSC 307(88) Annex 1 part 8/MED registration IMO

Light fastness: 5-8 (EN ISO 105 - B02)

Rubbing fastness: 4-5/4-5 (Wet/Dry) (EN ISO 105X12)

Pilling: 4 (EN ISO 12945-2)

Environmental facts: EU Ecolabel, Oeko-Tex® Standard 100, 100% free of heavy metals, ISO 14001 certified company

Design: Cenk Kivrikoglu

Produced in: Lithuania

Cleaning: Professional dry cleaning (For further info follow Gabriel's cleaning guidelines - www.gabriel.dk)



CAPTURE (GABRIEL) - PRICE GROUP 3

Capture is a lightly felted and multi-coloured wool fabric combining softness, stretch and strenght. It fuses light and dark colours to a refined melange pattern in subtle nuances, which add richness and depth to the design.

Composition: 85% New Zealand wool, 15% polyamide

Abrasion resistance: 200.000 Martindale (EN ISO 12947-2)

Flammability: BS EN 1021: 1-2 (Cigarette & match), BS 5852 Part 1 0,1 (Cigarette & match), CA TB 117-2013, Class Uno UNI 9175 Class 1 IM

Light fastness: 5-7 (EN ISO 105-B02)

Rubbing fastness: 4-5/4-5 (Wet/Dry) (EN ISO 105X12)

Pilling: 4-5 (EN-ISO 12945-2)

Environmental facts: EU Ecolabel, Oeko-Tex® Standard 100, 100% free of heavy metals, ISO 14001 certified company

Design: Cenk Kivrikoglu

Produced in: Lithuania

Cleaning: Professional dry cleaning (For further info follow Gabriel's cleaning guidelines - www.gabriel.dk)



FOCUS (GABRIEL) - PRICE GROUP 3

Focus is a woven felt fabric made of 100% long-staple worsted wool. It has an ultra soft and satiny touch combined with high strength obtained by use of high-quality worsted wool yarn and careful production processes. In addition to high durability, the fabric does not pill and will remain attractive over time regardless of wear and tear.

Composition: 100% New Zealand wool

Weight: 660 g/lm

Abrasion resistance: 100 000 Martindale (EN ISO 12947-2)

Flammability: BS EN 1021: 1-2 (Cigarette & match), BS 5852 Part 1 0.1 Cigarette and match, CA TB 117-2013, Class Uno UNI 9175 Class 1 I EMME, ÖNORM A33800-B1-B33825-Q1UK, AM 18 - NF D 60-013-(only for fabric)

Light fastness: 5-7 (EN ISO 105-B02)

Rubbing fastness: 4-5/4-5 (Wet/Dry) (EN ISO 105X12)

Pilling: 4 (EN ISO 12945-2)

Environmental facts: EU Ecolabel, Free of heavy metals and harmful chemicals, biodegradable, Oeko-Tex® Standard 100, ISO 14001 certified company

Design: Inger Mosholt Nielsen, colours Cenk Kivrikoglu

Produced in: Lithuania

Cleaning: Professional dry cleaning (For further info follow Gabriel´s cleaning guidelines – www.gabriel.dk)



FC61036

FC61039

FC60999

FC61042

FOCUS MELANGE (GABRIEL) - PRICE GROUP 3

Focus Melange is a woven felt fabric made of 100% long-staple worsted wool. It has an ultra soft and satiny touch combined with high strength obtained by use of high-quality worsted wool yarn and careful production processes. In addition to high durability, the fabric does not pill and will remain attractive over time regardless of wear and tear. The equal thickness between the warp and weft yarn give a harmonious and symmetric melange colour expression.

Composition: 100% New Zealand wool

Weight: 660 g/lm

Abrasion resistance: 100 000 Martindale (EN ISO 12947-2)

Flammability: BS EN 1021: 1-2 (Cigarette & match), BS 5852 Part 1 0.1 Cigarette and match, CA TB 117-2013, Class Uno UNI 9175 Class 1 I EMME, ÖNORM A33800-B1-B33825-Q1UK

Light fastness: 5-7 (EN ISO 105-B02)

Rubbing fastness: 4-5/4-5 (Wet/Dry) (EN ISO 105X12)

Pilling: 4 (EN ISO 12945-2)

Environmental facts: EU Ecolabel, Free of heavy metals and harmful chemicals, biodegradable, Oeko-Tex® Standard 100, ISO 14001 certified company

Design: Inger Mosholt Nielsen, colours Cenk Kivrikoglu

Produced in: Lithuania

Cleaning: Professional dry cleaning (For further info follow Gabriel´s cleaning guidelines – www.gabriel.dk)

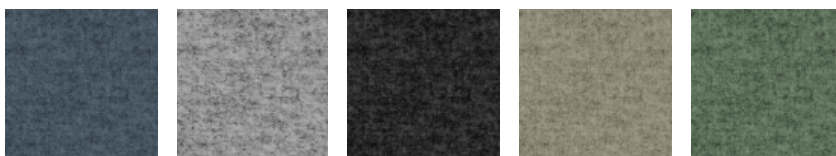

FCM60308

FCM60310

FCM60900

FCM61240

FCM68247

GAJA CLASSIC (GABRIEL) - PRICE GROUP 3

A classic cr pe structured fabric in pure new wool. Finishing treatment gives a soft surface. It has a wide colour range in both subdued and strong colours.

Composition: 100% pure new wool

Weight: 530 g/lm

Abrasion resistance: 50 000 Martindale (EN ISO 12947-2)

Flammability: BS EN 1021: 1-2 (Cigarette & match), BS 5852 0&1 (Cigarette & match), BS 5852 Crib 5, Calif. Bull. 117-2013, IMO A.652 (16), UNI 9175 Class 1 IM, BS 476 Part 7 Class 1 I

Light fastness: 5-7 (EN ISO 105-B02)

Rubbing fastness: 4-5/4-5 (Wet/Dry) (EN ISO 105X12)

Pilling: 4-5 (EN ISO 12945-2)

Environmental facts: EU Ecolabel, Free of heavy metals, Oeko-Tex® Standard 100, ISO 14001 certified company

Design: Dorte Bo Bojesen

Produced in: Lithuania

Cleaning: Professional dry cleaning (For further info follow Gabriel's cleaning guidelines - www.gabriel.dk)

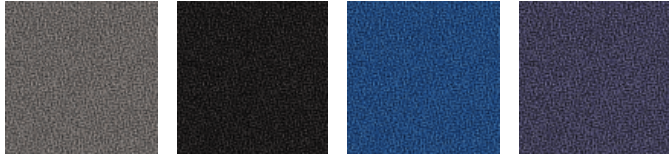

GA60003

GA60999

GA66004

GA66005

OCEANIC (CAMIRA) - PRICE GROUP 3

Oceanic is made from 100 % post-consumer recycled polyester yarn where 90% are created from post-consumer plastic bottles diverted from landfill and 10% is upcycled marine plastic(from marine litter). It is a fabric born out of the SEAQUAL Initiative designed to combat marine plastic pollution and achieve a waste free environment. Oceanic has a two coloured diagonal structure with a matte surface and soft touch.

Composition: 100 % post-consumer recycled polyester, including 50% SEAQUAL yarn

Weight: 497 g/m2 ±5%

Abrasion resistance: >100 000 Martindale (EN ISO 12947-2)

Flammability: BS EN 1021: 1-2 (Cigarette & match), BS 7176 Low, BS 7176 Medium Hazard with EnviroFlam5, CA TB 117-2013

Light fastness: 5 (EN ISO 105 - B02: 2013)

Rubbing fastness: 4/4 (Wet/Dry) (EN ISO 105X12)

Pilling: 4 (EN ISO 12945-2)

Environmental facts: EU Ecolabel, Oeko-Tex® Standard 100, Indoor Advantage™ "Gold", non metallic dyestuffs, ISO 14001 certified company.

Design: Camira Design Studio

Produced in: United Kingdom

Cleaning & disinfection: Washable at 60 °C and bleach cleanable (For further info follow Camira ´s cleaning guidelines - www.camirafabrics.com)



OCI001

OCI008

OCI014

OCI012

OCI011

PUXX 1 (ONIRO) - PRICE GROUP 3

PUxx 1 is a polyurethane leather with a soft touch that is easy to clean and disinfect. It is 100% waterproof, antibacterial & antifungal and resistant towards blood and urine. Being strong, durable and easy to maintain make it well suited for environments with high cleaning requirements.

Composition: Coating: 100% polyurethane with a cotton/polyester backing

Weight: 520 g/m²

Abrasion resistance: 300 000 Martindale (EN 530-2 (2010))

Flammability: BS EN 1021: 1-2 (Cigarette & match), CA TB 117-2013, BS 5852:2006 Crib 5, IMO 2010 FTP Code Annex 1 part 8

Light fastness: 6-7 (EN ISO 105-B02)

Rubbing fastness: 4-5/4-5 (Wet/Dry) (EN ISO 105X12.2016)

Environmental facts: Oeko-Tex® Standard 100, 100% free of heavy metals and harmful chemicals, ISO 14001 certified company

Design: Oniro Design team

Produced in: Belgium

Cleaning: Alcohol, hydrogen peroxide & chlorine solutions. Never use solvents. For more info please contact supplier www.oniro.nl

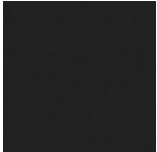

PU215816

PUXX 2 (ONIRO) - PRICE GROUP 3

PUxx 2 is a matte and smooth polyurethane leather with a soft touch that is easy to clean and disinfect. It is 100% waterproof, antibacterial & antifungal and resistant towards blood and urine. Being strong, durable and easy to maintain make it well suited for environments with high cleaning requirements.

Composition: Coating: 100% polyurethane with a cotton/polyester backing

Weight: 520 g/m²

Abrasion resistance: 300 000 Martindale (EN 530-2 (2010))

Flammability: BS EN 1021: 1-2 (Cigarette & match), CA TB 117-2013, BS 5852:2006 Crib 5, IMO 2010 FTP Code Annex 1 part 8

Light fastness: 6-7 (EN ISO 105-B02)

Rubbing fastness: 4-5/4-5 (Wet/Dry) (EN ISO 105X12.2016)

Environmental facts: Oeko-Tex® Standard 100, 100% free of heavy metals and harmful chemicals, ISO 14001 certified company

Design: Oniro Design team

Produced in: Belgium

Cleaning: Alcohol, hydrogen peroxide & chlorine solutions. Never use solvents. For more info please contact supplier www.oniro.nl



PU223043

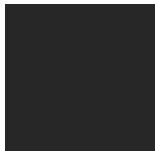

PU227001

ILLUSION (NEVOTEX) - PRICE GROUP 4

Illusion is a resistant easy cleanable synthetic leather with a polyurethane (PU) coating on a cotton backing. It has a semi matte surface with a softly grained structure and is recommended to use in environments with high cleaning demands.

Composition: Coating: 100% Polyurethane, Backing: 100% Cotton

Weight: 595 ± 30 g/m²

Abrasion resistance: 500 000 Martindale (EN ISO 5470-2:2003)

Flammability: BS EN 1021: 1-2 (Cigarette & match), CA TB 117-2013, BS 5852:2006 Crib 5, DiN 4102-1B2:1998 (B2), IMO 2010 FTP Code Annex 1 part 8

Light fastness: >7 (EN ISO 105-B02)

Rubbing fastness: 4-5/4-5 (Wet/Dry) (EN ISO 105X12.2016)

Surface resistance: 4-5 (EN12720)

Environmental facts: Oeko-Tex® Standard 100, Free of heavy metals and harmful chemicals, ISO 14001 certified company

Design: Nevotex Design team

Produced in: Belgium

Cleaning: Alcohol (75%), hydrogen peroxide & chlorine. For specific recommendations please contact supplier www.nevotex.com

Not approved for RH Logic 200/220 and RH Axia Exclusive



ILU110

STEELCUT 3 (KVADRAT) - PRICE GROUP 4

Steelcut 3 is a unicoloured strong worsted wool and polyamide woven fabric, combining durability, soft touch and colour depth. The construction create a three-dimensional surface resembling small pyramids or steel points. Despite its complex weaving technique, it has a simple and precise expression.

Composition: 90% worsted new wool, 10% polyamide

Weight: 825 g/lm

Abrasion resistance: 100 000 Martindale (EN ISO 12947-2)

Flammability: BS EN 1021: 1-2 (Cigarette & match, CA TB 117-2013, BS 5852 Crib 5 (with treatment), BS 5852 part 1, IMO FTP Code 2010 Part 8, NF D 60 013, NFPA 260, UNI 9175 1IM, ÖNORM B1/Q1, AS/NZS 3837 Class 2, ASTM E84 Class A Unadhered, ASTM 84 Class B Adhered

Light fastness: 5 6 (EN ISO 105-B02)

Rubbing fastness: 3-5/4-5 (Wet/Dry) (EN ISO 105X12)

Pilling: 3-4 (EN ISO 12945-2)

Environmental facts: EU Ecolabel, 100% free of heavy metals, ISO 14001 certified company, GREENGUARD Gold

Design: Frans Dijkmeijer, Giulio Ridolfo (updated colourways)

Produced in: United Kingdom

Cleaning: Professional dry cleaning with tetrachloroethylene, normal process (For further info follow Kvadrat's cleaning guidelines - www.kvadrat.dk)

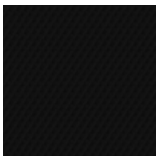

STT190

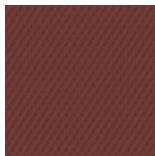

STT655

STEELCUT TRIO 3 (KVADRAT) - PRICE GROUP 4

Steelcut Trio 3 is a strong worsted wool and polyamide woven fabric, made with three different coloured yarns. The colours and the special weave create a three-dimensional surface where the colours seem to change depending on the angle of perspective. Like Steelcut 3, despite the complexity of the textile's innovative weave, it has a simple, precise expression.

Composition: 90% worsted new wool, 10% polyamide

Weight: 770 g/lm

Abrasion resistance: 100 000 Martindale (EN ISO 12947-2)

Flammability: BS EN 1021: 1-2 (Cigarette & match, CA TB 117-2013, BS 5852 Crib 5 (with treatment), BS 5852 part 1, BS 5852 ignition source 3, IMO FTP Code 2010 Part 8, NF D 60 013, NFPA 260, UNI 9175 1IM, ÖNORM B1/Q1, AS/NZS 3837 Class 2, GB 50222 B1 with treatment (Chinese)

Light fastness: 6-7 (EN ISO 105-B02)

Rubbing fastness: 3-5/4-5 (Wet/Dry) (EN ISO 105X12)

Pilling: 4 (EN ISO 12945-2)

Environmental facts: EU Ecolabel, 100% free of heavy metals, ISO 14001 certified company, GREENGUARD Gold

Design: Frans Dijkmeijer, Giulio Ridolfo (updated colourways)

Produced in: United Kingdom

Cleaning: Professional dry cleaning with tetrachloroethylene, normal process (For further info follow Kvadrat's cleaning guidelines – www.kvadrat.dk)

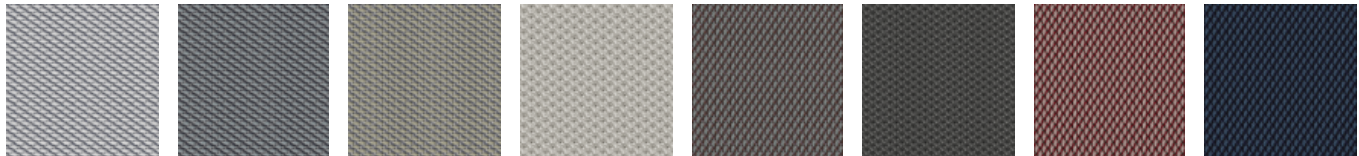

STT133

STT153

STT253

STT213

STT276

STT383

STT645

STT796

PALOMA SOFT (WOLLSDORF) - PRICE GROUP 6

High quality semi-aniline leather. All our standard colours from Paloma have a special finish adding a particular softness to the leather. Excellent friction and breathing properties. The surface may feature small scars and marks resulting from insect bites etc. These are proof of the natural origin of the product and are part of its character.

Flammability: BS EN 1021: 1-2 (Cigarette & match), BS 5852 Crib 5, IMO A.652 (16)

Light fastness: 6 (EN ISO 105-B02)

Rubbing: Wet 80/4 -Dry 2000/4 - Sweat 50/4 - ISO 11640

Finish-adhesion: 2,0 N/cm ISO 11644

Tear-strength: 20 N/mm DIN 53329- A

Environmental facts: Tanned without using chromium salts, BlueAngel, ECO2L-certificate, ISO 14001 certified company

Produced in: Austria

Animal Welfare: All hides are by-products from the meat and dairy industries, only use hides from healthy and uninjured animal. Following European standards as a minimum and the "Five Freedoms" of livestock as defined by FAWC (Farm Animal Welfare Council)

Cleaning: Follow the leather care guide from our supplier – www.wollsdorf.com

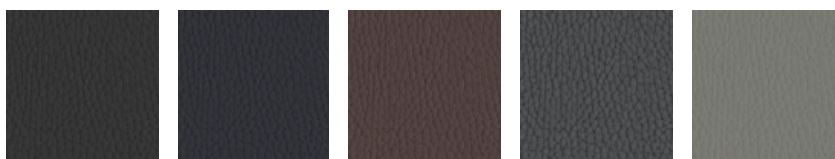

ATG56100

ATG55185

ATG55130

ATG55206

ATG55115

ELMOSOFT (ELMO) - PRICE GROUP 7

Elmosoft is a chrome free supreme quality semi-aniline grain leather from Scandinavian cattle. It is soft and pliable with an outstanding comfort and durability. Visible insect-bites and scars from healed wounds add to the authentic quality and character of the leather.

Thickness: 1.1 - 1.3 mm

Flammability: BS EN 1021: 1-2 (Cigarette & match), BS 5852 Crib 5, CA TB 117-2013, DIN 4102 -1 (B1), IMO 2010 FTP Code Part 8 (IMO652), UNI 9175, Önorm B 3825, UNI 9175

Light fastness: 6 (EN ISO 105-B02)

Rubbing: Wet 80/4 - Dry 2000/4 - Sweat 50/4 - ISO 11640

Finish-adhesion: ≥ 2 N/cm - ISO 11644

Tear-strength: ≥ 20 N/cm DIN 53329-A

Environmental facts: Free of heavy metals, tanned without using chromium salts, ISO 14001 certified company, Clean water tanning technology with biological Water Treatment Plant and 100% CO2 neutral on energy.

Animal Welfare: All hides are by-products from the meat and dairy industries with traceability back to the farm. Following strict regulations on animal welfare in compliance with national and international standards as those issued by the World Organization for Animal Health (6 animal welfare freedoms)

Produced in: Sweden

Cleaning: (Follow the guidelines by our supplier - www.elmoleather.com)

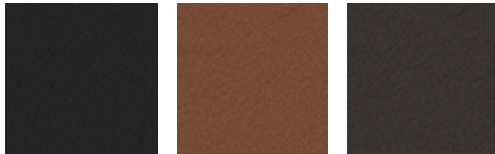

EL99999

EL33004

EL93068

DECORATIVE STITCHES

Decorative stitches can truly add the little extra to your chair.

The 10-colour thread program is available on all textiles for the following RH chairs: RH Logic 200/220, RH Logic 400/300, RH Mereo & RH Extend.

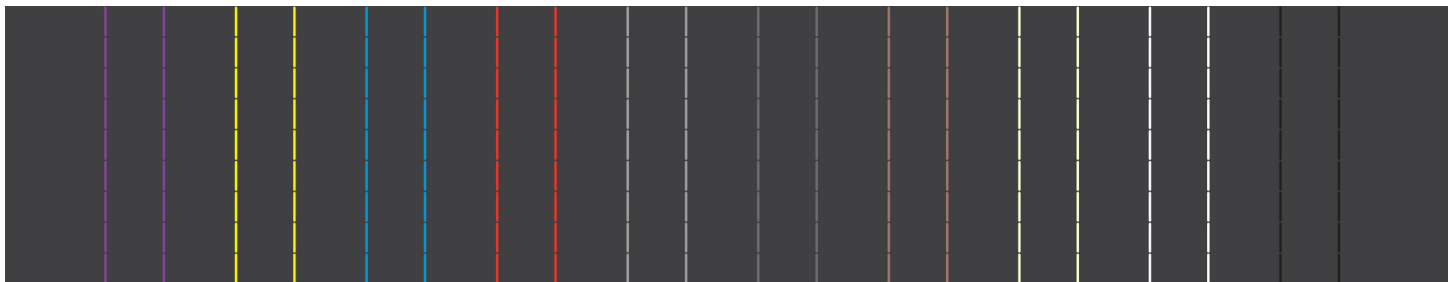

4908
Purple

1226
Yellow

6968
Turquoise

3822
Red

9389
Silver Grey

9582
Grey

8569
Beige

8135
Warm White

1712
Cold White

9700
Black

Fabrics 24/7

10 year guarantee as standard or 5 year guarantee on 24/7 use.

The 24/7 Standard Fabric & Colour Collection is our collection of fabrics, leathers and other materials.

The collection has been designed to bring out the best visual and functional qualities of these materials. All fabrics and leathers in our 24/7 Standard collection are of excellent quality. We offer short delivery times, a wide range and all our materials comply with strict environmental requirements. These fabrics are tested and approved according to our quality standards.

Maintenance: To maintain fabrics and leather, please vacuum with a furniture brush or use a clean cloth or sponge slightly dampened with clean lukewarm water.

NOTE! Colours on screen or in print might differ from reality. Other colours than listed here are in our Extended colour collection and might fall into a different price group. Please contact our Customer Service for more information.

24/7+ (CAMIRA) - PRICE GROUP 3

24/7+ is a tightly woven construction with inherent flame retardancy designed to withstand the rigorous 24/7 use. Made from highly resilient fibre types to create a textile that achieves optimum strength.

Composition: 50% polyamide, 33% wool, 10% Flame Retardant Viscose , 7% viscose

Weight: 435g/m2 ±5%

Abrasion resistance: >400 000 Martindale (EN ISO 12947-2)

Flammability: BS EN 1021: 1-2 (Cigarette & match), BS 7176 Medium Hazard, BS 5852 Section 4 Crib 5, UNI 9175 Class 1 IM

Light fastness: 5 (EN ISO 105-B02)

Rubbing fastness: 4/4 (Wet/Dry) (EN ISO 105X12)

Environmental facts: Manufacturing process - fully compliant with ISO 14001

Design: Camira Design Studio

Produced in: United Kingdom

Cleaning: Professional dry cleaning (For further info follow Camira's cleaning guide - www.camirafabrics.com)



WK 012

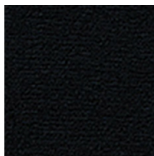

WK 017

DOLCE (SPRADLING) - PRICE GROUP 3

Dolce is a polyurethane based synthetic leather with a leather grain look. It is supple with a soft touch and a comfortable grip. It's high durability and good surface resistance makes it suitable for high demanding environments.

Composition: 100% Polyurethane (100% Rayon Backing)

Weight: 340.00gr/m2

**Abrasion resistance: 300 000 Martindale (EN ISO 12947-2)

Flammability: BS EN 1021: 1-2 (Cigarette & match), BS 5852 - Source#0, IMO Res. A.652 (16) 8.2,8.3 , CA TB 117-2013

UV stability: 4 (ASTM D1148)

Crocking resistance: 4(Wet/Dry) (AATCC8)

Environmental facts: ISO 14001 certified company, No heavy metals

Design: Spradling Design Team

Produced in: Germany

Cleaning & disinfection: For info follow cleaning guidelines www.spradling.com

NOTE! Only available for RH Secur 24 (inner seat- and back pad)

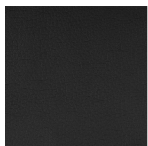

CBN6728

ULTRA (CLIMATEX/JAB) - PRICE GROUP 3

Ultra is a light and durable fabric made with a mix of natural and synthetic fibers, combined to fulfill the Climatex textile lock technology. This innovative weaving technique allows moisture and temperature to be regulated and provides the fabric with its flame-retardant and durable properties.

Composition: 72% Cradura TM, PA (Polyamide polymer) 16% wool, 12% Redesigned Lenzing FR TM , CV(Flame-resistant cellulosic fiber)

Abrasion resistance: 500 000 Martindale (EN ISO 12947-2)

Flammability: BS EN 1021: 1&2 (Cigarette & match), BS 5852-0/1, California TB 117-2013

Light fastness: 6-7 (EN ISO 105-B02)

Rubbing fastness: 4-5 (Wet/Dry) (EN ISO 105X12)

Environmental facts: Cradle to Cradle Silver, Oekotex 100, Recyclable with separable components, using renewable energy in production

Design: Climatex design studio

Produced in: Germany

Cleaning & disinfection: Professional dry cleaning (For further info please contact www.climatex@jab.de)

Available for RH Focus & RH Secur24

NOTE! CLI095 – to be ordered as Special request for RH Secur24

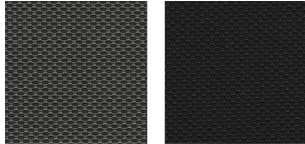

CLI095

CLI099

STACCATO (DUVALTEXT/GUILDFORD OF MAINE) - PRICE GROUP 5

Staccato is a highly durable fabric in polyamide with an acrylic backcoating designed for 24/7 use. It has a dotted texture in a diagonal pattern.

Composition: 100% Polyamide

Weight: 14.9 ± 1 oz./lin. yd.

Abrasion resistance: 150 000 Double rubs (ASTM D4157)

Flammability: CA TB 117-2013

Light fastness: 5-7 (EN ISO 105-B02)

Colourfastness to crocking: Grade 4 min. dry & Grade 3 min. wet (AATCC 8)

Pilling resistance: 5 (EN ISO 12945-2)

Produced in: North-America

Cleaning & disinfection: May be disinfected hydrogen peroxide, alcohol, and quaternary ammonium (quat) based cleaners. For more info see www.duvaltex.com)

Available for: RH Secur24, RH Focus, RH Logic 200/220 Elite

NOTE! SCO7033 & SCO7047 – to be ordered as Special request for RH Secur24

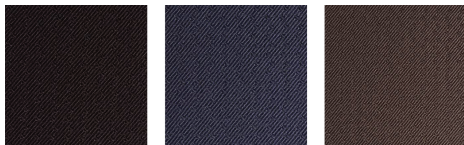

SCO7020

SCO7033

SCO7047

TRENTO + (VAN LEEUWEN) - PRICE GROUP 6

Trento + is a semi aniline leather with natural grain from European cow hides. It has a semi-matt appearance and a soft waxy feel. Through dyed with chrome tannage and with a pigmented protective coat finish.

Thickness: 0,9-1,1mm

Flammability: BS EN 1021: 1-2 (Cigarette & match), BS5852 1&2, IMO A.652 (16)

Light fastness: >5 (EN ISO 105-B02)

Rubbing: Wet >3/4 250 - Dry>4 500 (EN ISO 11640)

Finish-adhesion: ≥ 2 N/cm (EN ISO 11644)

Tear-strength: ≥ 20 N (EN ISO 3377 1+2)

Environmental facts: Blue Angel, ISO 14001 certified company

Produced in: Italy

Only available for RH Secure24



TR0760

ELMOSOFT (ELMO) - PRICE GROUP 7

Elmosoft is a chrome free supreme quality semi-aniline grain leather from Scandinavian cattle. It is soft and pliable with an outstanding comfort and durability. Visible insect-bites and scars from healed wounds add to the authentic quality and character of the leather.

Thickness: 1.1 - 1.3 mm

Flammability: BS EN 1021: 1-2 (Cigarette & match), BS 5852 Crib 5, CA TB 117-2013, DIN 4102 -1 (B1), IMO 2010 FTP Code Part 8 (IMO652), UNI 9175, Önorm B 3825, UNI 9175

Light fastness: 6 (EN ISO 105-B02)

Rubbing: Wet 80/4 - Dry 2000/4 - Sweat 50/4 - ISO 11640

Finish-adhesion: ≥ 2 N/cm - ISO 11644

Tear-strength: ≥ 20 N/cm DIN 53329-A

Environmental facts: Free of heavy metals, tanned without using chromium salts, ISO 14001 certified company, Clean water tanning technology with biological Water Treatment Plant and 100% CO2 neutral on energy.

Animal Welfare: All hides are by-products from the meat and dairy industries with traceability back to the farm, Following strict regulations on animal welfare in compliance with national and international standards as those issued by the World Organization for Animal Health (6 animal welfare freedoms)

Produced in: Sweden

Cleaning: (Follow the guidelines by our supplier - www.elmoleather.com)

Available for: RH Secur24, RH Focus, RH Logic 200/220 Elite

NOTE! EL33004, EL93068 - to be ordered as Special request for RH Secur24



EL33004

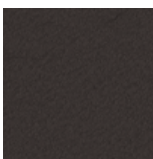

EL93068



EL99999

Extended Fabric & Colour Collection

In addition to our Standard Fabric & Colour Collection we also offer an expanded selection of textiles in different colours from different textile suppliers who we work with.

* Non-standard colours

OR = Price on request

1) Not approved for RH Logic 220/200

2) Only for RH Focus, RH Secur24 & RH Axia Exclusive

3) Only for RH Axia 2.5

4) Not approved for RH Mereo, RH Extend, RH Activ & RH Support

5) Only approved for RH Axia

NOTE! Some fabrics in our Collections may not be approved for all RH chairs, please contact our Customer Service for more information.

SUPPLIER/COLLECTION	PRICE GROUP	SUPPLIER/COLLECTION	PRICE GROUP
Ambla - www.ambla.com			
Exmoor	4	Gabriel - www.gabriel.dk	
Wild Heather	4	Breeze Fusion ¹⁾	4
		Capture*	3
		Comfort +	5
		Crisp ¹⁾	3
		Cura *	3
		Fame	3
		Focus *	3
	OR	Focus Melange *	3
	3	Focus Royal	3
	3	Gaja Classic *	3
	3	Gaja C2C	3
	3	Go Check (Trevira CS)	3
	3	Harmony	3
	3	Lense	3
	3	Renewed loop	3
	4	Select *	2
	4	Step (Trevira CS)	3
	3	Step Melange (Trevira CS)	3
	3	Tonal	3
	3	Umber	3
		Guilford of Maine - www.guilfordofmaine.com	
	3	Staccato ⁴⁾	5
		GU - www.gu.no	
	5	Amdal	4
	5	Bardal	4
		Gandal +	4
		Heidal	4
	OR	Mandal	3
	OR		
		Hornschuch/Skai - www.skai.com	
	3	Skai Mano-S ⁵⁾	3
		Krall & Roth - www.krallroth.com	
		Shrinx Join ^{* 3)}	OR
		Shrinx Wool ³⁾	OR
Camira Fabrics - www.camirafabric.com			
24/7+	3		
24/7 Flax	3		
Blazer	3		
Era	3		
Hi-Tech ESD *	OR		
Mainline Flax	3		
Mainline Twist	3		
Nexus	3		
Oceanic *	3		
Quest	3		
RePlay	3		
Rivet	3		
Revolution	4		
Sumi	4		
Synergy	3		
Urban	3		
Xtreme *	3		
Climatex/Jab - www.climatex.jab.de			
Ultra ^{* 2)}	3		
De Ploeg - www.deploeg.com			
Ploegwool	5		
Stavanger	5		
Elmo - www.elmoleather.com			
Elmosoft *	OR		
Elmosoft Piqué *	OR		
Fidivi - www.fidivi.com			
Bondai	3		

SUPPLIER/COLLECTION

PRICE GROUP

SUPPLIER/COLLECTION

PRICE GROUP

Kvadrat - www.kvadrat.dk

Canvas 2 ¹⁾	4
Clara 2 ⁵⁾	4
Divina 3	5
Divina MD	5
Divina Melange 3	5
Fiord	4
Foss	5
Hallingdal 65	5
Melange Nap **	4
Naveli	4
Remix 3 ¹⁾	3
Re-wool **	3
Sport	4
Steelcut 3 *	4
Steelcut Trio 3 *	4
Steelcut Quartet	5
Tonus 4	5
Twill Weave *	5
Vidar	6

Nevotex - www.nevotex.se

Antistatic Synthetic leather	3
Illusion * ⁵⁾	4
Illusion Full grain ⁵⁾	4

* Non-standard colours

** Non-curated colours

OR = Price on request

¹⁾ Only approved for RH Logic 400/300, RH Extend, RH Activ

²⁾ Only approved for RH Logic 400/300, RH Mereo, RH Extend, RH Activ

³⁾ Not approved for RH Secur24, RH Focus

⁴⁾ Only approved Logic 300/400, RH Axia

⁵⁾ Not approved for Logic 200/220

Oniro - www.oniro.nl

Puxx 1 *	3
Puxx 2 *	3

Serge Ferrari - www.sergeferrari.com

Stamskin Top ⁴⁾	4
----------------------------	---

Spradling - www.spradling.eu

Dolce	4
Valencia	3

Svensson - www.ludvigsvensson.com

Khaki (Trevira CS)	3
Node	4
Step	4

Vescom - www.vescom.com

Gamut	4
Acton	4

Wollsdorf - www.wollsdorf.com

Paloma - Leather ³⁾	OR
--------------------------------	----

Flokk & Kvadrat Curated Collection

Flokk & Kvadrat Curated Collection is a carefully selected collection of textiles and colours chosen to provide more specific and inspiring choices for our customers.

The assortment consists of four different ranges of textiles in a variety of colours and textures – each with distinct features and expressions.

The textile and colour diversity reflects high design and quality and meets the technical and environmental requirements for office interiors and public spaces.

For technical specification, product description and colour overview see website and colour card.

NOTE! Some fabrics in our Collections may not be approved for all RH chairs, please contact our Customer Service for more information.

Curated textiles and colours in price group 3

Re-Wool: 128, 198, 448, 458, 558, 568, 628, 648, 718, 758, 768, 858

Curated textiles and colours in price group 4

Melange Nap: 111, 171, 191, 211, 241, 371, 411, 521, 651, 751, 911, 951

Curated textiles and colours in price group 5:

Twill Weave: 190, 280, 430, 530, 780, 940, 990

For more information see our website: [Flokk and Kvadrat curated Collection](#)



Fabric requirement

Fabric requirements for customer fabrics: width 150 cm (130 cm). Note! Allow for fabric manufacturers pattern-matching. For information about RH Axia, RH Focus & RH Secur24 please Contact Customer Service

Product	1 unit	2 units	3 units	4 units	6 units	8 units	10 units	Leather 1 unit*
RH Merco 200	70(80) cm	140(160) cm	210(240) cm	270(310) cm	410(470) cm	540(630) cm	670(780) cm	2 m ²
RH Merco 220	90(100) cm	165(190) cm	245(280) cm	320(370) cm	480(560) cm	630(740) cm	790(920) cm	2.5 m ²
RH Merco 220 with neckrest	110(120) cm	185(220) cm	280(300) cm	350(380) cm	530(590) cm	690(760) cm	870(940) cm	2.5 m ²
RH Merco 300	90(100) cm	165(190) cm	245(280) cm	320(370) cm	480(560) cm	630(740) cm	790(920) cm	2.5 m ²
RH Extend 100	65(65) cm	105(115) cm	145(165) cm	195(210) cm	300(335) cm	400(440) cm	470(535) cm	2 m ²
RH Extend 120	65(90) cm	105(140) cm	155(190) cm	215(240) cm	310(370) cm	420(480) cm	530(600) cm	2 m ²
RH Extend 200	65(65) cm	105(115) cm	145(165) cm	195(210) cm	300(335) cm	400(440) cm	470(535) cm	2 m ²
RH Extend 220	65(90) cm	105(140) cm	155(190) cm	215(240) cm	310(370) cm	420(480) cm	530(600) cm	2 m ²
RH Logic 200	80(90) cm	140(150) cm	220(250) cm	300(340) cm	450(500) cm	590(660) cm	730(840) cm	app. 2 m ²
RH Logic 220	90(115) cm	150(180) cm	210(280) cm	290(360) cm	430(540) cm	580(730) cm	710(920) cm	app. 2 m ²
RH Logic 300 with neckrest	80(110) cm	150(170) cm	220(250) cm	300(340) cm	450(500) cm	590(660) cm	730(840) cm	app. 2 m ²
RH Logic 300 without neckrest	80(90) cm	140(150) cm	200(230) cm	260(300) cm	400(440) cm	520(590) cm	650(740) cm	app. 2 m ²
RH Logic 300 Elegance with neckrest	100(115) cm	190(220) cm	280(320) cm	380(430) cm	580(650) cm	770(870) cm	950(1080) cm	app. 2.5 m ²
RH Logic Elegance 300 without neckrest	100(110) cm	170(200) cm	250(300) cm	340(400) cm	520(590) cm	700(790) cm	870(1000) cm	app. 2.5 m ²
RH Logic 400 with neckrest	90(115) cm	160(190) cm	240(280) cm	320(380) cm	480(560) cm	640(740) cm	790(930) cm	app. 2 m ²
RH Logic 400 without neckrest	90(115) cm	150(180) cm	210(360) cm	290(360) cm	430(540) cm	580(730) cm	710(920) cm	app. 2 m ²
RH Logic 400 Elegance with neckrest	110(130) cm	210(260) cm	310(390) cm	420(520) cm	630(760) cm	830(1000) cm	1040(1280) cm	app. 2.5 m ²
RH Logic 400 Elegance without neckrest	110(130) cm	200(260) cm	290(390) cm	380(520) cm	590(760) cm	780(1000) cm	980(1280) cm	app. 2.5 m ²
RH Activ 200	60(60) cm	90(100) cm	130(150) cm	170(200) cm	250(300) cm	340(390) cm	420(490) cm	1.5 m ²
RH Activ 220	60(60) cm	100(120) cm	150(170) cm	200(230) cm	290(330) cm	390(450) cm	480(550) cm	1.7 m ²
RH Activ 202	60(60) cm	100(120) cm	140(170) cm	190(220) cm	270(320) cm	360(430) cm	460(530) cm	1.7 m ²
RH Activ 222	60(80) cm	110(130) cm	160(180) cm	210(240) cm	310(360) cm	410(480) cm	510(600) cm	1.7 m ²
RH Support 4501	60(62) cm	85(90) cm	115(130) cm	150(175) cm	220(250) cm	285(340) cm	370(420) cm	1.7 m ²
RH Support 4511	120(120) cm	120(120) cm	120(120) cm	120(170) cm	210(240) cm	270(300) cm	330(390) cm	
RH Support 4521	60(60) cm	60(95) cm	110(110) cm	110(155) cm	110(215) cm	220(300) cm	220(370) cm	

Physical measurements - Work chairs

PHYSICAL MEASUREMENTS - WORK CHAIRS

Measurements in mm. Given measurements are based on EN 1335-1

Model	Seat height (standard 4T NPR)	Seat height (B)	Seat height (4T)	Seat height (A)
RH Logic 200	406-550	480-610	394-526	495-625
RH Logic 220	406-550	480-610	394-526	495-625
RH Logic 200 Elite	426-570	500-630	414-546	515-645
RH Logic 220 Elite	426-570	500-630	414-546	515-645
	Seat depth	Seat width	Seat depth with slide	Seat angel adjustment
RH Logic 200	477	442	386-484	-15.5°/+8.6°
RH Logic 220	477	442	400-499	-15.5°/+8.6°
	Backrest height	Backrest width	Backrest height adjustment	Backrest angle adjustment
RH Logic 200	518	431	490-588	19°
RH Logic 220	620	433	581-681	21°
	Height of armrest above seat 8L	Height of armrest above seat 8L BS	Diameter of base	Weight (kg)
RH Logic 200	199-315	199-315	680	19.9
RH Logic 220	199-315	199-315	680	20.4
RH Logic 200 Elite	179-295	179-295	680	21
RH Logic 220 Elite	179-295	179-295	680	22.8

Model	Seat height (standard 4Q)	Seat height (B)	Seat height (A)	-
RH Logic 300	410-530	480-610	495-625	-
RH Logic 300 Elite	430-550	500-630	515-645	-
RH Logic 400	410-530	480-610	495-625	-
RH Logic 400 Elite	430-550	500-630	515-645	-
	Seat depth	Seat width	Seat depth with slide	Seat angel adjustment
RH Logic 300	467	462	384-443	-13.4°/+5.4°
RH Logic 300 Elite	467	462	384-443	-13.4°/+5.4°
RH Logic 400	467	462	384-443	-17.2°/+4.6°
RH Logic 400 Elite	467	462	384-443	-17.2°/+4.6°
	Backrest height	Backrest width	Backrest height adjustment	Backrest angle adjustment
RH Logic 300	510	447	514-592	15.2°
RH Logic 300 Elite	510	447	514-592	15.2°
RH Logic 400	620	447	624-703	15.2°
RH Logic 400 Elite	620	447	624-703	15.2°
	Height of armrest above seat 8E & 8S	Height of armrest above seat 8S XL	Diameter of base	Weight (kg)
RH Logic 300	198-299	223-325	660	21
RH Logic 300 Elite	178-279	203-305	660	21
RH Logic 400	198-299	223-325	660	21.8
RH Logic 400 Elite	178-279	203-305	660	21.8

Model	Seat height (standard 4T NPR)	Seat height (B)	Seat height (4T)	Seat height (A)
RH Mereo 200	395-525	480-610	388-520	495-625
RH Mereo 220	395-525	480-610	388-520	495-625
RH Mereo 300	395-525	480-610	388-520	495-625
	Seat depth	Seat width	Seat depth with slide	Seat angel adjustment
RH Mereo 200	470	407	398-494	-16°/+7.7°
RH Mereo 220	470	407	397-491	-16°/+7.7°
RH Mereo 300	470	407	394-488	- 16°/+7.7°
	Backrest height	Backrest width	Backrest height adjustment	Backrest angle adjustment
RH Mereo 200	470	365	432-510	19.8°
RH Mereo 220	630	365	582-657	19.8°
RH Mereo 300	630	442	580-656	19.8°
	Height of armrest above seat 8T	-	Diameter of base	Weight (kg)
RH Mereo 200	195-310	-	680	18.4
RH Mereo 220	195-310	-	680	18.9
RH Mereo 300	195-310	-	680	18.9

Model	Seat height (standard gas stem 4Q)	Seat height (4P)	-	-
RH Extend 100	420-534	440-550	-	-
RH Extend 200	420-534	440-550	-	-
RH Extend 120	420-534	440-550	-	-
RH Extend 220	420-534	440-550	-	-
	Seat depth	Seat width	Seat depth with slide	Seat angle adjustment
RH Extend 100	465	461	400-480	- 10° +3°
RH Extend 200	465	461	400-480	- 10°/+3°
RH Extend 120	465	461	400-480	- 10°/+3°
RH Extend 220	465	461	400-480	- 10°/+3°
	Backrest height	Backrest width	Backrest height adjustment	Backrest angle adjustment
RH Extend 100	510	440	455-535	-
RH Extend 200	510	440	455-535	24°
RH Extend 120	620	440	640-720	-
RH Extend 220	620	440	640-720	24°
	Height of armrest above seat (8E & 8S)	-	Diameter of base	Weight (kg)
RH Extend 100	220-297	-	660	19
RH Extend 200	220-297	-	660	19
RH Extend 120	220-297	-	660	19.8
RH Extend 220	220-297	-	660	19.8

Model	Seat height (B)	Seat height (D)	Seat height (A)	Seat height (4FL)	Seat height (E)
RH Activ 200	392-522 (standard)	590-680	437-573	370-460	600-850
RH Activ 202	392-522 (standard)	590-680	437-573	370-460	600-850
RH Activ 220	392-522 (standard)	590-680	437-573	370-460	600-850
RH Activ 222	392-522 (standard)	590-680	437-573	370-460	600-850
RH Activ 301	-	590-680 (standard)	437-573	-	600-850
RH Activ 302	-	590-680 (standard)	437-573	-	600-850
RH Activ 303	-	590-680 (standard)	437-573	-	600-850
	Seat depth	Seat width	Seat depth with slide	Seat angle adjustment	
RH Activ 200	430	440	390-445	- 7°/+6°	
RH Activ 202	460	460	420-475	- 7°/+6°	
RH Activ 220	430	440	390-445	- 7°/+6°	
RH Activ 222	460	460	420-475	- 7°/+6°	
RH Activ 301	430	440	385-435	- 5°/+15°	
RH Activ 302	460	460	390-445	- 5°/+15°	
RH Activ 303	428	450	420-475	- 5°/+5°	
	Backrest height	Backrest width	-	Backrest angle adjustment	
RH Activ 200	295	370	-	23°	
RH Activ 202	295	370	-	23°	
RH Activ 220	430	370	-	23°	
RH Activ 222	430	370	-	23°	
RH Activ 301	230	280	-	23°	
RH Activ 302	230	280	-	23°	
RH Activ 303	230	280	-	23°	
	Height of armrest above seat (8E & 8S)	-	Diameter of base	Weight (kg)	
RH Activ 200	190-290	-	590	13	
RH Activ 202	190-290	-	590	13	
RH Activ 220	190-290	-	590	13.6	
RH Activ 222	190-290	-	590	13.6	
RH Activ 301	-	-	590	13	
RH Activ 302	-	-	590	13	
RH Activ 303	-	-	590	13.6	

Model	Seat height (standard E)	Seat height (B)	Seat height (D)	Seat height (A)	Seat height (4FL)
RH Support 4501	565-810	375-510	485-545	415-545	345-430
RH Support 4511	580-825	390-525	500-680	430-560	360-445
RH Support 4521	656-810	375-510	485-665	415-545	345-430
	Seat depth	Seat width	Backrest height	Backrest width	
RH Support 4501	380	410	230	380	
RH Support 4511	-	Ø350	230	380	
RH Support 4521	240	450	230	380	
	-	-	Diameter of base	Weight (kg)	
RH Support 4501	-	-	590	10.6	
RH Support 4511	-	-	590	10.5	
RH Support 4521	-	-	590	10.5	

Model	Seat height (standard 4F Logic)	Seat height (gas stem 4B chrome)	-	-
RH Logic 300 ESD	440-560	480-610	-	-
RH Logic 400 ESD	440-560	480-610	-	-
RH Extend 200 ESD	440-560	-	-	-
RH Extend 220 ESD	440-560	-	-	-
	Seat depth	Seat width	Seat slide	Seat angle adjustment
RH Logic 300 ESD	465	457	384-443	-17.2°/+4.6°
RH Logic 400 ESD	465	457	384-443	-17.2°/+4.6°
RH Extend 200 ESD	465	461	400-480	-10°/+3°
RH Extend 220 ESD	465	461	400-480	-10°/+3°
	Backrest height	Backrest width	Backrest height adjustment	Backrest angle adjustment
RH Logic 300 ESD	510	447	514-592	15.2°
RH Logic 400 ESD	620	447	624-703	15.2°
RH Extend 200 ESD	508	444	455-535	24°
RH Extend 220 ESD	623	443	640-720	24°
	Height of armrest above seat (8E ESD)	-	Diameter of base	Weight (kg)
RH Logic 300 ESD	198-299	-	660	21°
RH Logic 400 ESD	198-299	-	660	21.8°
RH Extend 200 ESD	220-297	-	660	35°
RH Extend 220 ESD	220-297	-	660	37°

Model	Seat height (standard B chrome)	Seat height (gas stem E chrome)	Seat height (gas stem D chrome)	Seat height (gas stem ON-4FH black)	Seat height (gas stem 4FL chrome)
RH Activ 200 ESD	392-522	605-855	515-690	459-607	375-465
RH Activ 220 ESD	392-522	605-855	515-690	459-607	375-465
RH Activ 222 ESD	392-522	605-855	515-690	459-607	375-465
	Seat depth	Seat width	Seat slide	Seat angle adjustment	
RH Activ 200 ESD	430	440	390-445	- 7°/+6°	
RH Activ 220 ESD	430	440	390-445	- 7°/+6°	
RH Activ 222 ESD	460	460	420-475	- 7°/+6°	
	Backrest height	Backrest width	Backrest height adjustment	Backrest angle adjustment	
RH Activ 200 ESD	295	370		20°	
RH Activ 220 ESD	430	370		23°	
RH Activ 222 ESD	430	370		23°	
	Height of armrest above seat (8E ESD)	-	Diameter of base	Weight (kg)	
RH Activ 200 ESD	190-290	-	590	13	
RH Activ 220 ESD	190-290	-	590	13.6	
RH Activ 222 ESD	190-290	-	590	13.6	

Seat slide

Model	Seat height (standard B chrome)	Seat height (gas stem E chrome)	Seat height (gas stem D chrome)	Seat height (gas stem ON-4FH black)	Seat height (gas stem 4FL chrome)
RH Activ ESD Cleanroom 200	392-522	605-855	515-690	459-607	375-465
RH Activ ESD Cleanroom 220	392-522	605-855	515-690	459-607	375-465
	Seat depth	Seat width	Seat slide	Seat angle adjustment	
RH Activ ESD Cleanroom 200	430	440	390-445	- 7°/+6°	
RH Activ ESD Cleanroom 220	430	440	390-445	-7°/+6°	
	Backrest height	Backrest width	-	Backrest angle adjustment	
RH Activ ESD Cleanroom 200	295	370	-	20°	
RH Activ ESD Cleanroom 220	430	370	-	23°	
	Height of armrest above seat (8E ESD)	-	Diameter of base	Weight (kg)	
RH Activ ESD Cleanroom 200	190-290	-	590	13	
RH Activ ESD Cleanroom 220	190-290	-	590	13.6	

RH

Model	Seat height (standard B black) (B silver)	Seat height (gas stem E chrome)	Seat height (gas stem D black)	Seat height (gas stem 4FL chrome)	Seat height (gas stem A black)
RH Activ Cleanroom 200	392-522	605-855	500-680	370-460	437-573
RH Activ Cleanroom 220	392-522	605-855	500-680	370-460	437-573
	Seat depth	Seat width	Seat slide	Seat angle adjustment	
RH Activ Cleanroom 200	430	440	390-445	-7°/+6°	
RH Activ Cleanroom 220	460	460	390-445	-7°/+6°	
	Backrest height	Backrest width	Backrest height adjustment	Backrest angle adjustment	
RH Activ Cleanroom 200	295	370		20°	
RH Activ Cleanroom 220	430	370		23°	
	Height of armrest above seat (8E ESD)	-	Diameter of base	Weight (kg)	
RH Activ Cleanroom 200	190-290	-	590	13	
RH Activ Cleanroom 220	190-290	-	590	13.6	

Model	Seat height (standard ON-4S)	Seat height (gas stem ON-4FZ)	Seat height (gas stem ON-4FH)	
RH Secure24	400-520	440-590	490-640	
RH Secur24 Exclusive	400-520	440-590	490-640	
	Seat depth	Seat width	Seat slide	Seat angle adjustment
RH Secur24	435	410	140 mm	+4,8° / - 13,9°
RH Secur24 Exclusive	435	410	140 mm	+4,8° / - 13,9°
	Backrest height	Backrest width	Backrest height adjustment	Backrest angel adjustment
RH Secur24	829	481	-	18.4°
RH Secur24 Exclusive	829	481	-	18.4°
	Height of armrest above seat 8SC	Height of armrest above seat 8SC XL	Height of armrest above seat 8F	Height of armrest above seat 8H
RH Secur24			247	247
RH Secur24 Exclusive			247	247
			Diameter of base	Weight (kg)
RH Secur24			710	37.6
RH Secur24 Exclusive			710	37.6

Model	Seat height (standard ON-4FZ)	Seat height (ON-4FH)		
RH Focus	420-555	450-600		
	Seat depth	Seat width	Seat slide	Seat angle adjustment
RH Focus	475	468	425-505	-4.9-(+) 11.2°
	Backrest height	Backrest width	Backrest height adjustment	Backrest angle adjustment
	684	480	-	32.3°
	Height of armrest above seat 8K	Height of armrest above seat 8K XL	Height of armrest above seat 8H	Height of armrest above seat 8F
RH Focus	199-305	199-305		170-325
			Diameter of base	Weight (kg)
RH Focus			710	23.9 kg

Model	Seat height (standard ON-4UZ)	Seat height (ON-4FH)	Seat height (ON-4V)	
RH Axia 2.1, 2.2, 2.3, 2.4, 2.5	380-530	450-600		
RH Axia Exclusive	400-550		450-600 mm	

	Seat depth	Seat width	Seat slide	Seat angle adjustment
RH Axia 2.1, 2.2, 2.3, 2.4, 2.5	470	490	318-469	+5° / - 14°
RH Axia Exclusive	470	490	383-470	+5° / - 9°
	Backrest height	Backrest width	Backrest height adjustment	Backrest angle adjustment
RH Axia 2.1	390	450	170-230	15°
RH Axia 2.2	470	450	170-230	15°
RH Axia 2.3	470	450	170-230	15°
RH Axia 2.4	540	460	170-230	15°
RH Axia 2.5	560	460	170-230	15°
RH Axia Exclusive	650	480	150-270	23°
	Height of armrest above seat 8N	Height of armrest above seat 8N XL	Diameter of base	Weight (kg)
RH Axia 2.1, 2.2, 2.3, 2.4, 2.5	215-310	215-310	670	19.7 kg
RH Axia Exclusive	194-298	194-298	710	21.8

Tests and Certificates

An RH chair is built to withstand stress and to last. All chairs are therefore rigorously tested and approved according to known standards for different markets

PRODUCT FAMILY	Technical certificates					Environmental certificates				
	EN 1335	GS	BS 5459	ANSI BIFMA	IEC 61340-ESD	Möbelfakta	EPD ISO 14025	GREEN-GUARD	Cradle to Cradle	Nordic Swan
RH Logic 200/220	x	x	x	x		x	x	x		
RH Logic 400/300	x		x		x	x	x	x		x
RH Mereo	x	x		x		x	x	x		
RH Axia	x	x	x				x		x	
RH Axia Exclusive	x						x			
RH Extend	x	x	x		x	x	x	x		
RH Activ	x	x	x	x	x	x	x	x		
RH Support							x	x		
RH Secur24	x	x	x							
RH Focus	x	x	x	x						

NOTE! The list is not a full overview of RH portfolio and its models. For more information and details, please contact our Customer Service.

RH Quick-ship

RH Quick-ship consists of our most popular chairs. RH Quick-ship collection offers a delivery of only five business days from the factory after the order is placed. Please add transport days.

To ensure delivery, the maximum order is 10 chairs, requests for larger volumes, please contact us.

You can supplement the chair with the following accessories:

- Neckrest
- Armrests
- Gas lift in varying seat heights.
- Castors for soft floors and hard floors.

Model	Item no	Fabric and colour						
		Gaja Black - 60999	Paloma Soft - Black 56100	Puxx 1 Black - 215816	24/7 - WK012	Select Black - 60999	Select Grey - 60134	
RH Mereo 200 Silver	8111	x	x			x	x	
RH Mereo 220 Silver	8211	x	x			x	x	
RH Mereo 300 Silver	8311	x	x			x	x	
RH Mereo 200 Black	8112	x	x			x	x	
RH Mereo 220 Black	8212	x	x			x	x	
RH Mereo 300 Black	8312	x	x			x	x	
RH Mereo 200 Silver Grey	8113	x	x			x	x	
RH Mereo 220 Silver Grey	8213	x	x			x	x	
RH Mereo 300 Silver Grey	8313	x	x			x	x	
RH Logic 200 Black	9112					x	x	
RH Logic 220 Black	9212					x	x	
RH Logic 200 Silver	9111					x	x	
RH Logic 220 Silver	9211					x	x	
RH Logic 300	3540	x	x			x	x	
RH Logic 400	3350	x	x			x	x	
RH Logic 400 Elite	3559		x					
RH Extend 100	6212					x	x	
RH Extend 120	6112					x	x	
RH Extend 200	6211					x	x	
RH Extend 220	6111					x	x	
RH Activ 200	2772			x		x	x	
RH Activ 220	2872			x		x	x	
RH Activ 222	2882			x		x	x	
RH Support 4501 (Saddle)	4501			x				



Flokk is the leading manufacturer of high-quality workplace furniture in Europe, with a strong foothold in North America, developing a growing family of global brands. We are the proud owner of product brands HÅG, Offecct, Giroflex, RH, Profim, Stylex, 9to5 Seating, Connection and Malmstolen. A structured focus on the environment through several decades has enabled us to be a leader in the development of sustainable furniture.

Our head office is in Oslo, Norway, with main production sites in Røros (Norway), Nässjö (Sweden), Turek (Poland), Huddersfield (UK) Delanco NJ (USA) and Hawthorne CA (USA). In addition, we keep sales offices in Norway, Sweden, Denmark, Germany, Belgium, the Netherlands, UK, France, Switzerland, Singapore, USA, Canada, China and Australia. Flokk products are sold in more than 80 countries worldwide. About 1800 employees work together to realize the vision of Flokk:
Inspire great work

Flokk A/S
Sorgenfrivej 18
DK - 2800 Kongens Lyngby

Phone: +45 99 50 55 00
E-mail: info-dk@flokk.com
www.flokk.com