

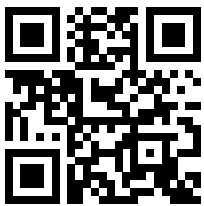

giroflex 313 swivel chair

Designed by Paolo Fancelli
for Flokk brand Giroflex

Learn more about
giroflex 313



The giroflex 313: Designed for mobility, flexibility, and simplicity.

In response to the growing need for adaptable workspaces, the giroflex 313 is stripped down to the essentials—without compromising on comfort or energising ergonomics. Less truly is more.

A chair to share

With height as the only adjustment needed, it delivers a premium seating experience that fits seamlessly into open workspaces, project rooms, and meeting areas.

The giroflex 313 offers a wide range of design combinations, making it the perfect choice for any environment.

Synchro-motion

This chair series features an automatic self-adjusting synchro motion mechanism, specially developed to ensure optimal support for every user, every time.

Recommended workspace

The giroflex 313 is the chair to share, with height as only adjustment needed, and a perfect design with a broad spectre of combinations to complement different open workspaces, project rooms, and meeting rooms where a premium seating experience is required.

Measurements

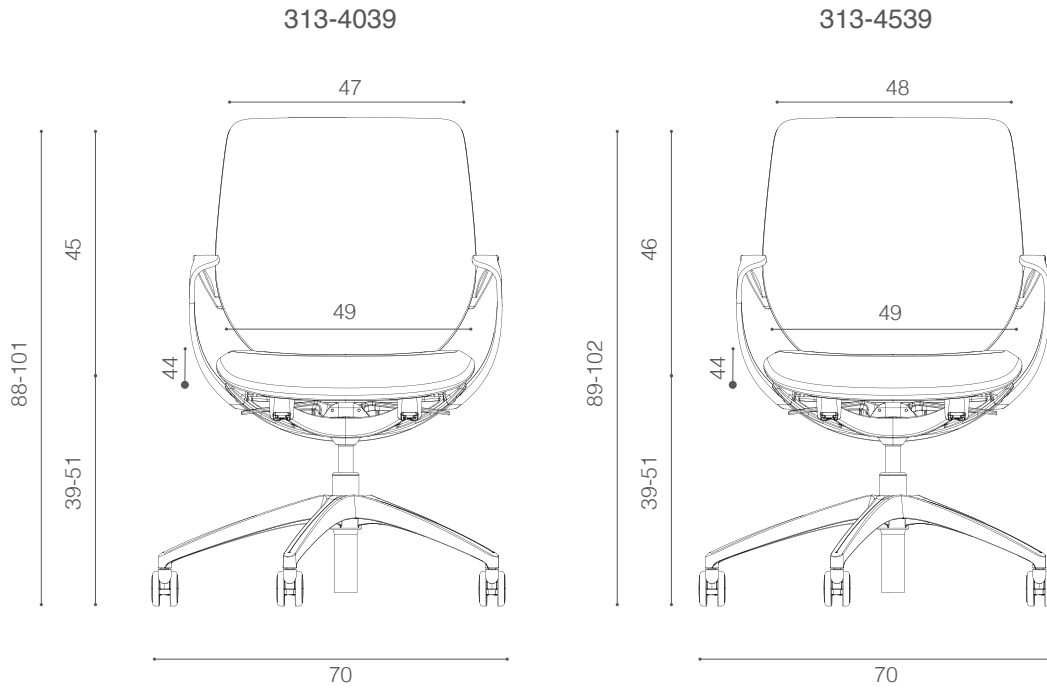

Armrest cannot be added or removed in a later stage.

giroflex 313	-4039	-4539
Seat height loaded	39–51cm	39–51cm
Total height	88–101cm	89–102cm
Backrest height above seat	45cm	46cm
Seat width	49cm	49cm
Backrest width	47cm	48cm
Total width (5-arm base)	70cm	70cm
Seat depth	44cm	44cm
Mechanism automatic adaption to the body weight	45-120kg	45-120kg

Models and Measurements (acc. to EN 1335) | Measurements can vary slightly from chair to chair

Technical description

Automatic Synchro motion mechanism	Giroflex in-house development, patented Aluminium diecasting design, powder coated or polished aluminium finish Synchronous movement Automatic weight adaption - 45 - 120kg Linear back contact pressure during the entire mechanical operation Backrest inclination angle = 0-21° Auto synchro-motion, lockable in full upright position Seat /backrest ratio = 1:3 Seat surface inclination angle = -1° to -8°
Base	5-arm aluminium diecast base, powder coated or polished aluminium finish (option)
Castors	Dual wheel castors Ø65mm, load-dependent braking, black, acc. to EN 12527 and EN 12529 for hard or soft floors
Column	Standard component for seat height Type approved acc. to EN16955 Infinitely adjustable range = 12cm Strength class 4
Controls	Option: Extra seat heights: see price-list "special seat heights" The controls are positioned so to be easily accessible, when sitting in the chair. Handle (left) for seat height adjustment Handle (right) for locking backrest tilt in full upright position
Seat shell	Polyamide with 15% glas (PA6 GF15), black 810, structured surface
Seat upholstery plate	Polypropylene (PP)
Mesh back	Pronounced ergonomic design for optimal adaptation and support. The mesh fabric RUNNER from Gabriel guarantees optimal comfort and air circulation
Backrest frame	Polyamide with 15% glas (PA6 GF15), black 810, structured surface
Backrest upholstery plate (upholstered backrest only)	Polypropylene (PP), black 810, structured surface
Shape of seat and backrest 2-zone seat	The front part (approx. 1/3 of the seat surface) has a 7° forward tilt to relieve pressure on thighs. The rear part supports the pelvic area and prevents the occupant from sliding forward. Backrest: Pronounced ergonomic design for optimal adaptation and support of the back

Technical description

Upholstering foam	PUR-foam, free of CFC Flame retardant as per: <ul style="list-style-type: none">- EN 1021-1:2014- EN 1021-2:2014- CAL TB 117- BS 5852: Part 2: 1982, Ignition source 5 (Crib 5) with melamine Foam-hardness according to DIN53576c / ISO2439: <ul style="list-style-type: none">- Seat 270N \pm10%- Backrest 270N \pm10% Volume weight \sim 60kg/m ³		
Seat and backrest cushion upholstered	Can be exchanged on site (at the workplace)		
Covering materials	Spacer fabric backrest <ul style="list-style-type: none">- Colours from the Runner-Collection (http://www.gabriel.dk)- Three-dimensional honeycomb design- Optimum cushioning effect and support of the back- Excellent air permeability, optimal climate- 100% PES, OEKO TEX 100 Upholstered backrest and seat Fabrics from the following collections: <ul style="list-style-type: none">- Xtreme (www.camirafabrics.com)- Grano (http://www.climatex.com)- Gaja Classic (http://www.gabriel.dk)- Step (http://www.gabriel.dk)- Select (http://www.gabriel.dk)- Comfort+ (http://www.gabriel.dk)- skai@Palma (http://www.hornschuch.com) Leather from the Giroflex-Collection. Customers own material (COM) if suitable. Detailed technical information on fabrics see the homepages or the fabric sample cards.		
Powder coating	Epoxy-Polyester mixed powder mixing ratio \sim 50:50 Colours: <ul style="list-style-type: none">- 810 black- 812 perl-metallic- 813 alu-metallic		
Armrests	Fixed armrests, Polyamide with 15% glass (PA6 GF15), black 810, structured surface	Fixed armrests, aluminium diecast, powder coated or polished aluminium finish	
	Height of armpad above seat loaded:	23cm	23cm
	Clear width between the armrests:	47,5cm	47,5cm
	Distance to seat front edge:	15,5cm	16,2cm
	Width of armpad:	4,7cm	6,5cm
	Length of armpad:	23,5cm	22,8cm

Configurations

Mesh back



Upholstered back

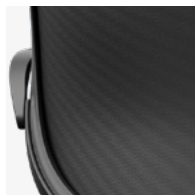

CleanGuard seat

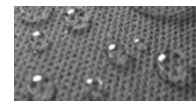

Back and seat frame colour

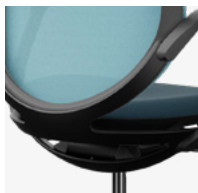

Frame steel,
black 810



Frame steel,
pearl-metallic
812



Frame steel,
alu-metallic
813



Frame steel,
polished

Footbase



5-arm
aluminium,
black 810



5-arm
aluminium,
pearl-metallic
812



5-arm
aluminium,
alu-metallic
813



5-arm
aluminium,
polished

Column



Standard column, on
standard seat height
39-51 cm, black



Standard column, on
standard seat height
39-51 cm, chromium
plated

Seat height:
49-65cm 57-74cm
52-69cm 64-81cm

Castors



Castors 65 mm
for soft / hard
floors



Castors 65 mm
for soft / hard
floors - broken
when loaded



Glides /
Glides with felt

Armrest



Fixed, black 810

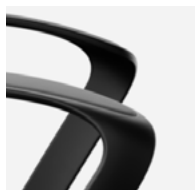

Fixed, aluminium support
black 810



Fixed, aluminium support
pearl-metallic 812



Fixed, aluminium support
alu-metallic 813

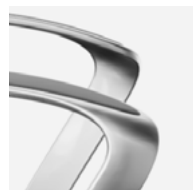

Fixed, aluminium support
polished

Footring



Cover materials

Mesh back Runner

- Colours from the Runner-Collection (<http://www.gabriel.dk>)
- Three-dimensional honeycomb design
- Optimum cushioning effect and back support
- Excellent air permeability, optimal climate
- 100% PES, Öko-Tex 100
- Flame retarding acc. to EN 1021-1 &-2, DIN 4102: B1

Upholstered seat

- Full Giroflex fabric, vinyl and leather range is available

You can find detailed fabric information in the Giroflex price list

Certifications and environment

Certifications

- EPD
- GREENGUARD Gold
- GS-Certificate (EN1335-1/-2 Type B)

Basic version of giroflex 313				
Recyclable materials	Material	Spacer Fabric backrest	Upholstered backrest	Recyclable
Column & Steel parts	Fe	13,3%	12,4%	100%
Aluminium	Al	39,5%	36,8%	100%
Textile	PUR CFC-free	4,2%	6,8%	100%
Plastic	PP / PA	36,9%	38,4%	100%
Wood	-	-	-	-
Components (e.g. castors)	PA / Fe	4,2%	3,9%	50%
Covering materials		1,9%	1,8%	Up to 100%
Total weight		12,5kg	13,5kg	

All plastic parts are identified acc. to ISO/DIS 11469 (identification of specific types)

Plastics: Recycled material proportion of "non-visible parts" up to 100%

CO₂-neutral label available at customer's request



giroflex 313 conference chair

Designed by Paolo Fancelli
for Flokk brand Giroflex

Learn more about
giroflex 313

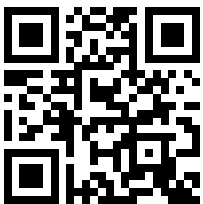

The giroflex 313: Designed for mobility, flexibility, and simplicity.

In response to the growing need for adaptable workspaces, the giroflex 313 is stripped down to the essentials—without compromising on comfort or energising ergonomics. Less truly is more.

A chair to share

With height as the only adjustment needed, it delivers a premium seating experience that fits seamlessly into open workspaces, project rooms, and meeting areas.

The giroflex 313 offers a wide range of design combinations, making it the perfect choice for any environment.

Synchro-motion

This chair series features an automatic self-adjusting synchro motion mechanism, specially developed to ensure optimal support for every user, every time.

Recommended workspace

The giroflex 313 is the chair to share, with height as only adjustment needed, and a perfect design with a broad spectre of combinations to complement different open workspaces, project rooms, and meeting rooms where a premium seating experience is required.

Measurements

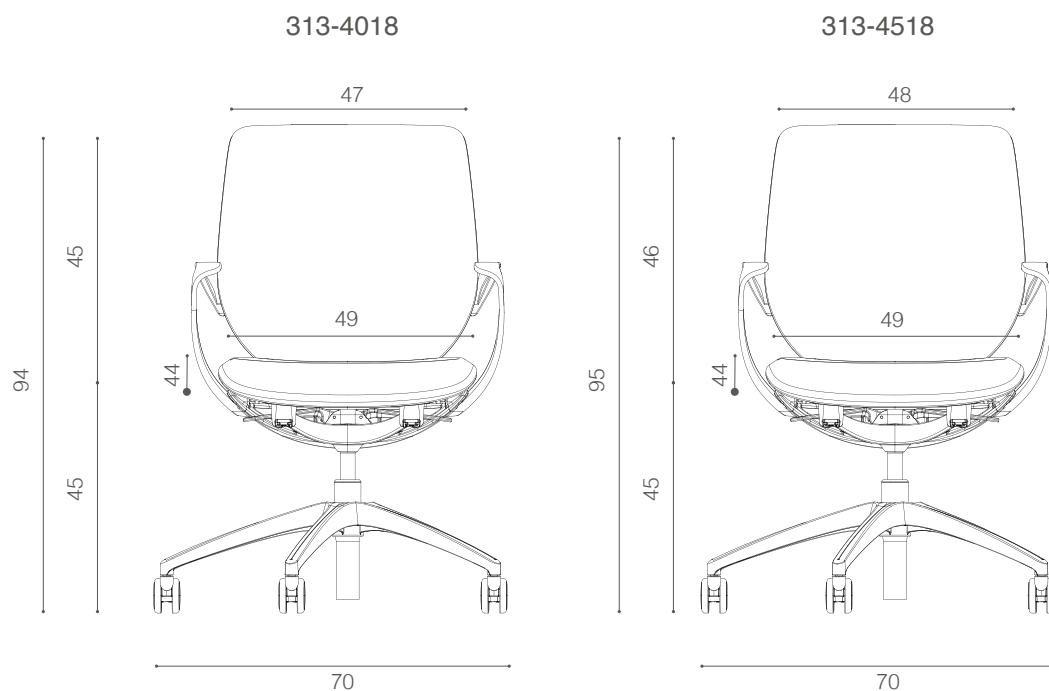

Armrest cannot be added or removed in a later stage.

giroflex 313	-4018	-4518
Seat height loaded	45cm	45cm
Total height	94cm	95cm
Backrest height above seat	45cm	46cm
Seat width	49cm	49cm
Backrest width	47cm	48cm
Total width (4-arm base)	70cm	70cm
Seat depth	44cm	44cm
Mechanism automatic adaption to the body weight	45-120kg	45-120kg

Models and Measurements (acc. to EN 1335) | Measurements can vary slightly from chair to chair

Technical description

Automatic Synchro motion mechanism	Giroflex in-house development, patented Aluminium diecasting design, powder coated or polished aluminium finish Synchronous movement Automatic weight adaption - 45 - 120kg Linear back contact pressure during the entire mechanical operation Backrest inclination angle = 0 - 13° Seat surface inclination angle = 0° - 3.7° Seat /backrest ratio = 1:2,7 Freefloat, not lockable
Base	4-arm aluminium diecast base, powder coated or polished aluminium finish (option)
Castors	Dual wheel castors Ø 65mm (auto-braking on request), black, acc. to EN 12527 EN 12529 for hard or soft floors
Column	Conference column, not height-adjustable, seat height 45cm Integrated end position cushioning plus rubber buffer 8mm, Black surface finish Option: - Height adjustable column, seat height 39 – 47cm - Auto-return column (angle of rotation), seat height 44cm, not height-adjustable, base with glides only
Controls	Option (in combination with height adjustable columns only): Handle (left) for seat height adjustment
Seat shell	Polyamid with 15% glas (PA6 GF15), black 810, structured surface
Seat upholstery plate	Polypropylene (PP)
Mesh back	Pronounced ergonomic design for optimal adaptation and support. The mesh fabric RUNNER from Gabriel guarantees optimal comfort and air circulation
Backrest frame	Polyamide with 15% glas (PA6 GF15), black 810, structured surface
Backrest upholstery plate (upholstered backrest only)	Polypropylene (PP), black 810, structured surface
Shape of seat and backrest 2-zone seat	The front part (approx. 1/3 of the seat surface) has a 7° forward tilt to relieve pressure on thighs. The rear part supports the pelvic area and prevents the occupant from sliding forward. Backrest: Pronounced ergonomic design for optimal adaptation and support of the back

Technical description

Upholstering foam	PUR-foam, free of CFC Flame retardant as per: - EN 1021-1:2014 - EN 1021-2:2014 - CAL TB 117 - BS 5852: Part 2: 1982, Ignition source 5 (Crib 5) with melamine Foam-hardness according to DIN53576c / ISO2439: - Seat 270N ±10% - Backrest 270N ±10% Volume weight ~60kg/m ³		
Seat and backrest cushion upholstered	Can be exchanged on site (at the workplace)		
Covering materials	Spacer fabric backrest: - Colours from the Runner-Collection (http://www.gabriel.dk) - Three-dimensional honeycomb design - Optimum cushioning effect and support of the back - Excellent air permeability, optimal climate - 100% PES, OEKO TEX 100 Upholstered backrest and seat Fabrics from the following collections: - Xtreme (www.camirafabrics.com) - Grano (http://www.climatex.com) - Gaja Classic (http://www.gabriel.dk). - Step (http://www.gabriel.dk) - Select (http://www.gabriel.dk) - Comfort+ (http://www.gabriel.dk) - skai@Palma (http://www.hornschuch.com) Leather from the Giroflex-Collection. Customers own material (COM) if suitable. Detailed technical information on fabrics see the homepages or the fabric sample cards.		
Powder coating	Epoxy-Polyester mixed powder mixing ratio ~50:50 Colours: - 810 black - 812 perl-metallic - 813 alu-metallic		
Armrests	Fixed armrests, Polyamide with 15% glass (PA6 GF15), black 810, structured surface	Fixed armrests, aluminium diecast, powder coated or polished aluminium finish	
	Height of armpad above seat loaded:	23cm	23cm
	Clear width between the armrests:	47,5cm	47,5cm
	Distance to seat front edge:	15,5cm	16,2cm
	Width of armpad:	4,7cm	6,5cm
	Length of armpad:	23,5cm	22,8cm

Configurations

Mesh back



Upholstered back

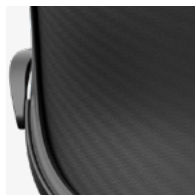

CleanGuard seat

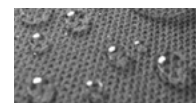

Back and seat frame colour

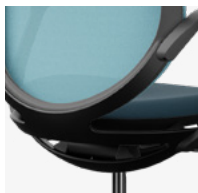

Frame steel,
black 810



Frame steel,
pearl-metallic
812



Frame steel,
alu-metallic
813



Frame steel,
polished

Footbase



4-arm
aluminium,
black 810



4-arm
aluminium,
pearl-metallic
812



4-arm
aluminium,
alu-metallic
813



4-arm
aluminium,
polished

Column

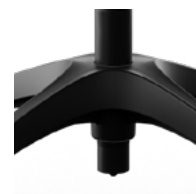

Column Conference
black

Column height
adjustable, black

Column auto-return,
black



Column fixed,
chromium plated

Column height
adjustable,
chromium plated

Column auto-return,
chromium plated

Castors



Castors 65 mm
for soft / hard
floors



Glides /
Glides with felt

Armrest



Fixed, black 810

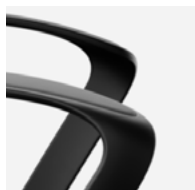

Fixed, aluminium support
black 810



Fixed, aluminium support
pearl-metallic 812



Fixed, aluminium support
alu-metallic 813

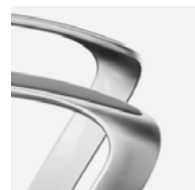

Fixed, aluminium support
polished

Cover materials

Mesh back Runner

- Colours from the Runner-Collection (<http://www.gabriel.dk>)
- Three-dimensional honeycomb design
- Optimum cushioning effect and back support
- Excellent air permeability, optimal climate
- 100% PES, Öko-Tex 100
- Flame retarding acc. to EN 1021-1 &-2, DIN 4102: B1

Upholstered seat

- Full Giroflex fabric, vinyl and leather range is available

You can find detailed fabric information in the Giroflex price list

Certifications and environment

Certifications

- EPD (353-4029)
- GREENGUARD Gold
- GS-Certificate (EN1335-1/-2 Type B)
- NPR

Basic version of giroflex 313				
Recyclable materials	Material	Spacer Fabric backrest	Upholstered backrest	Recyclable
Column & Steel parts	Fe	11,2%	10,3%	100%
Aluminium	Al	39,4%	36,5%	100%
Textile	PUR CFC-free	4,5%	7,3%	100%
Plastic	PP / PA	39,3%	40,7%	100%
Wood	-	-	-	-
Components (e.g. castors)	PA / Fe	3,6%	3,3%	50%
Covering materials		2,1%	1,9%	Up to 100%
Total weight		11,7kg	12,6kg	

All plastic parts are identified acc. to ISO/DIS 11469 (identification of specific types)

Plastics: Recycled material proportion of "non-visible parts" up to 100%

CO₂-neutral label available at customer's request